



MIDLAND
COUNTY ROAD COMMISSION
2334 N. MERIDIAN ROAD
SANFORD, MI 48657

Phone (989) 687-9060
Fax (989) 687-9121
www.midlandroads.com

Notice of Advertisement

Bids will be received by **Midland County Road Commission**, 2334 North Meridian Road, Sanford, MI 48657, until 1:00 pm on October 3, 2017 for the reconstruction of Shaffer Road over the Bliss Drain in Warren Township.

Construction to start no later than October 16, 2017 and must be open to traffic by November 13, 2017, with final completion by June 1, 2018.

Project Description: This project involves the reconstruction of Shaffer Road over Bliss Drain. The project includes road work, earth excavation, construction of proposed bridge, with Geosynthetic Reinforced Soil Abutments, precast/post tensioned concrete deck, guardrail, maintenance of traffic, HMA paving, placing granular material, slope protection and rip rap. The contractor will be responsible for the supply and installation of the precast/post tensioned concrete deck and steel rail system.

Plans, bid form and specifications may be obtained by qualified Bidders at the office of Midland County Road Commission, 2334 North Meridian Road, Sanford, MI 48657 at no charge.

MIDLAND COUNTY ROAD COMMISSION

STANDARD INSTRUCTIONS TO BIDDERS

1. RECEIPT AND OPENING OF PROPOSALS: Sealed bids will be accepted and time stamped upon receipt in the office of the Midland County Road Commission, located at 2334 N. Meridian Rd., Sanford, Michigan, 48657, until the indicated date on the attached Proposal.
2. BID FORM: Proposals shall be submitted on the enclosed form.
3. SUBMISSION OF BIDS:
 - (a) Envelopes containing bids must be submitted in a sealed, envelope and marked on the face with the name and address of bidder, date and hour of opening, and name of items in bid. Email Option: Bids may be emailed to Brenda@midlandroads.com. Subject line must state confidential bid and list project name. Email time stamp shall govern.
 - (b) Any proposals received after the advertised time for opening shall be declared void. This applies to bids sent by mail as well as those delivered.
 - (c) Any bidder may withdraw his bid by written request at any time prior to the advertised time for opening.
 - (d) Telephone or faxed bids are not acceptable. Telephone or faxed amendments or withdrawals will not be accepted under any circumstances.
 - (e) Unless otherwise specified, no bid may be withdrawn for a period of thirty (30) days from date of bid opening.
 - (f) Negligence on the part of the bidder in preparing the bid confers no rights for the withdrawal of the bid after it has been opened.
 - (g) Proposals received prior to time of opening will be securely kept unopened. No responsibility will attach to an officer or person for the premature opening of a proposal not properly addressed and identified.
 - (h) Prime contractor must perform at least 40% of the work and meet MDOT prequalification 543Fa or 543Ea. The Contractor shall include a copy of MDOT prequalification letter with the bid.
 - (i) Bidder further agrees to pay liquidated damages in accordance with Section 108 of the MDOT 2012 Standard Specifications for Construction.
4. SALES AND EXCISE TAXES:

The Contractor shall include and will be deemed to have included in its bid and contract price all applicable Michigan Sales and Use taxes which have been enacted into law as of the date the bid is submitted. To the extent of any conflict, this Special Provision controls over Division 1 of the 2012 MDOT Standard Specification for Construction.
5. All materials shall meet and/or conform to Michigan Department of Transportation specifications and certification slips shall be provided upon request. Further information may be obtained from the Midland County Road Commission's office.
6. All construction work performed within the county right-of-way will require appropriate traffic control according to the current Michigan Department of Transportation

specifications.

7. FREIGHT PREPAID

8. INSURANCE:

- (a) Title VI Certification: The Midland County Road Commission assures all its programs and activities will be free from discrimination, whether those programs and activities are federally funded or not.
- (b) A Certificate of Insurance will be supplied by the bidders for contractor work naming the Midland County Road Commission, its Commissioners and its employees as additionally insured.
- (c) Contractor must submit a proposal guaranty sum in the amount of \$25,000.

9. The Midland County Road Commission reserves the right to reject any and all proposals, to waive any irregularities in the proposals received in accordance with the 2012 Michigan Department of Transportation (MDOT) Standard Specifications for Construction.

10. This projects is partially funded by the Federal Highway Transportation Program and as a result all contractors are required to comply with Federal Labor Standard Procedures, Equal Opportunity Requirements and Davis Bacon Wage Requirements.

11. The contractor, sub recipient or subcontractor shall not discriminate on the basis of race, color, national origin, or sex in the performance of this contract. The Contractor shall carry out applicable requirements of 49 CFR Part 26 in the award and administration of US Dot-assisted contracts. Failure by the contractor to carry out these requirements is a material breach of this contract, which may result in the termination of this contract or such other remedy as the recipient deems appropriate.

12. Any construction contract modifications will be processed per the MDOT 2012 Standard Specifications for Construction, Division 1.

13. SEASONAL LIMITATION:

This is an expedited contract and seasonal limitations do not apply until the project is approved by the Engineer as open to traffic.

14. ADDENDUMS:

In the case that an addendum is issued prior to the opening of the bids, the bidder agrees to submit with the bid proposal a signed "Acknowledgement of Receipt" for each addendum.

Midland County Road Commission

Schedule of Items (Itemized Bid Sheet)

Letting Date Tuesday, October 3, 2017 1:00 PM

Contract ID 56000 201251A
Location Shaffer Road over Bliss Creek
Description Replace existing 10' culvert with 22' span GRS/IBS bridge

Project Number 201251A	Project Engineer Terry Palmer
Estimate Number 1	Date Created 8/24/2017
Project Type Miscellaneous	Fed State ER-1756(016)
Location Shaffer Road over Bliss Creek	Fed Item RT0741
	Control Section 56000

Description Replace existing 10' culvert with 22' span GRS/IBS bridge

Instructions to Bidders IMPORTANT NOTICE:
 Prime Contractor must be Mdot Prequalified 543 Ea or Fa

This project involves the construction of Shaffer Road over the Bliss Drain. The project includes road work, earth excavation, construction of proposed bridge, with Geosynthetic Reinforced Soil Abutments, precast/post tensioned concrete deck, guardrail, maintenance of traffic, HMA paving, placing granular material, slope protection and rip rap.

The undersigned understands and agrees that the local agency reserves the right to reject any and all bids and no contractual relationship shall exist between the undersigned and the local agency for the work described herein until such time as award is formally given.

The undersigned agrees upon submitting this bid that its agents, officers or employees have not directly or indirectly entered into any agreements, participated in any collusion, or otherwise taken any action in restraint of free competitive bidding in connection with this proposal for the above project.

Subject to Section 102.17 of the MDOT Standard Specifications for Construction, the undersigned agrees to pay to the Midland County Road Commission (Local Agency) the proposal guaranty sum of: 25,000.00, if the undersigned fails to provide the required materials and/or execute the contract in accordance with Section 102.15 of the MDOT Standard Specifications for Construction within twenty-eight (28) days after being furnished with necessary contract and bond forms. The Local Agency may, upon request by the undersigned based on valid considerations and made prior to expiration of the twenty-eight (28) day period, extend said period of time as the Local Agency may deem appropriate. A written request for return, or cancellation, of the proposal guaranty under Section 102.17 of the MDOT Standard Specifications for Construction must be filed with the Local Agency within fifteen (15) days after mailing by the Local Agency of notice that the proposal guaranty is being forfeited. Upon an adverse decision by the committee or failure to file a timely request for return, or cancellation, of proposal guaranty, payment shall be made within 20 days after the mailing by the Local Agency of a Final Demand for Payment. If payment is not made within 20 days, the undersigned hereby authorizes the Local Agency to withhold said sum from any money which may now, or hereafter, become due and owing by the Local Agency to the undersigned.

COMPANY BIDDING _____

CONTACT PERSON _____

ADDRESS _____

PHONE/FAX _____

 AUTHORIZED SIGNATURE TITLE

INDICATE ON ENVELOPE: Company Name, Bid Item, Time and Date

Pay Item	Description	Quantity	Units	Unit Price		Bid Amount	
				Dollars	Cts	Dollars	Cts
1500001	Mobilization, Max 49,000.00	1	LSUM				
2040035	Guardrail, Rem	492	Ft				
2050041	Subgrade Undercutting, Type II	50	Cyd				
2057002	_ Machine Grading, Modified	1	Sta				
2057021	_ Granular Embankment, AASHTO #89 Stone	1,352	Cyd				
2060010	Excavation, Fdn	1,623	Cyd				
2080036	Erosion Control, Silt Fence	400	Ft				
2080044	Erosion Control, Turbidity Curtain, Shallow	50	Ft				
3010002	Subbase, CIP	38	Cyd				
3020020	Aggregate Base, 8 inch	312	Syd				
3027021	_ RSF, MDOT 21AA, CIP, Crushed Limestone	125	Cyd				
3070125	Shoulder, CI II, 3 inch	178	Syd				
3087011	_ High Strength Woven Polypropylene Fabric	8,236	Syd				
5010005	HMA Surface, Rem	166	Syd				
5010703	HMA, LVSP	85	Ton				
7040007	Cofferdams	1	LSUM				
7067001	_ Concrete Cap	112	Ft				
7067001	_ Reinforcement, Steel, Epoxy Coated Dowel	722	Ft				
7067050	_ Solid Concrete Masonry Block	1,386	Ea				
7067050	_ Splitface Concrete Masonry Block	2,618	Ea				
7087051	_ Precast Concrete Planks, Modified	1	LSUM				
7117001	_ Bridge Railing	60	Ft				

Pay Item	Description	Quantity	Units	Unit Price		Bid Amount		
				Dollars	Cts	Dollars	Cts	
8070000	Guardrail, Type B	221	Ft					
8070040	Guardrail Approach Terminal, Type 1B	2	Ea					
8077050	_ Guardrail Anch, Bridge, Nested	4	Ea					
8110233	Pavt Mrkg, Waterborne, 6 inch, White	444	Ft					
8110234	Pavt Mrkg, Waterborne, 6 inch, Yellow	278	Ft					
8120012	Barricade, Type III, High Intensity, Double Sided, Lighted, Furn	7	Ea					
8120013	Barricade, Type III, High Intensity, Double Sided, Lighted, Oper	7	Ea					
8120170	Minor Traf Devices	1	LSUM					
8120350	Sign, Type B, Temp, Prismatic, Furn	336	Sft					
8120351	Sign, Type B, Temp, Prismatic, Oper	336	Sft					
8137011	_ Riprap, Heavy, Modified	275	Syd					
8167011	_ Slope Restoration, Modified	910	Syd					
Total Bid								

DESIGNATED and SPECIALTY ITEMS

DESIGNATED ITEMS:

COMPANY NAME AND ADDRESS OF
PREQUALIFIED SUBCONTRACTOR
DOING WORK:

(Ea) Grading, Drainage Structures, and
Aggregate Construction

(COMPANY NAME)

(COMPANY ADDRESS)

(Fa) Bridges and Special Structures

(COMPANY NAME)

(COMPANY ADDRESS)

(COMPANY NAME)

(COMPANY ADDRESS)

(COMPANY NAME)

(COMPANY ADDRESS)

(COMPANY NAME)

SPECIALTY ITEMS:

(COMPANY ADDRESS)

(COMPANY NAME)

SEE NEXT PAGE FOR INFORMATION ON
COMPLETING THIS PAGE

(COMPANY ADDRESS)

INFORMATION ON COMPLETION OF DESIGNATED AND SPECIALTY ITEMS PAGE

The contractor may sublet the item(s) of work stipulated on the DESIGNATED and SPECIALTY ITEMS page in this bid in accordance with Section 1.08.01 of the 2012 Standard Specifications, Section VII of the required provisions for Federal-Aid Contracts (with the exception noted in the following paragraph), and the following instructions.

The percentage of contract work performed by a contractor's own organization shall comply with Section 1.08.01 of the 2012 Standard Specifications, rather than the lower percentage allowed by Section VII of FHA required contract provisions (form FHWA 1273). Section 108.01 of the 2012 Standard Specifications requires forty percent (40%) performance by a contractor's own organization.

If the contractor **IS NOT** prequalified in EITHER the DESIGNATED or SPECIALTY ITEMS noted in this bid, the contractor MUST, prior to contract award, indicate the company name and address of a prequalified subcontractor in the space provided. If such company name is provided, the contractor MUST sublet the appropriate items to the prequalified subcontractor named, **unless the subcontractor is not prequalified at the time the work is to be performed, or the subletting of the item to another prequalified subcontractor is agreed to in writing by both the contractor and the named subcontractor.**

If the contractor **IS** prequalified in EITHER the DESIGNATED or SPECIALTY ITEMS noted in this bid and does not intend to do the work with its own forces, the contractor may indicate the company name and address of a prequalified subcontractor in the space provided. If such company name is provided, the contractor MUST sublet the appropriate items to the prequalified subcontractor named, **unless the subcontractor is not prequalified at the time the work is to be performed, or the subletting of the item to another prequalified subcontractor is agreed to in writing by both the contractor and the named subcontractor.**

If the contractor **IS** prequalified in the DESIGNATED or SPECIALTY ITEMS noted and NO subcontractor is named, any later decision to subcontract said items of work is subject to the sixty percent (60%) limitation of subcontracting.

At the time that a subcontractor is named in a bid to perform any of the DESIGNATED or SPECIALTY ITEMS, that subcontractor must be prequalified for the classification which includes the work it is to perform. In selecting a subcontractor, the prime contractor shall assure itself that the prospective subcontractor has sufficient equipment, working force, and supervision to complete the designated or specialty items to be subcontracted within the specified time limit.

It is understood and agreed that the prequalification of the subcontractor by the Department pursuant to 1933 P.A. 170 is not a guarantee or warranty of the subcontractor's ability to perform or complete the work contained herein.

Rev. (09/11)

ACORD™ CERTIFICATE OF LIABILITY INSURANCE

DATE (MM/DD/YY)
09/14/1999

PRODUCER

Serial # A1067

THIS CERTIFICATE IS ISSUED AS A MATTER OF INFORMATION ONLY AND CONFERS NO RIGHTS UPON THE CERTIFICATE HOLDER. THIS CERTIFICATE DOES NOT AMEND, EXTEND OR ALTER THE COVERAGE AFFORDED BY THE POLICIES BELOW.

INSURERS AFFORDING COVERAGE

INSURED

INSURER A:

INSURER B:

INSURER C:

INSURER D:

INSURER E:

COVERAGES

THE POLICIES OF INSURANCE LISTED BELOW HAVE BEEN ISSUED TO THE INSURED NAMED ABOVE FOR THE POLICY PERIOD INDICATED. NOTWITHSTANDING ANY REQUIREMENT, TERM OR CONDITION OF ANY CONTRACT OR OTHER DOCUMENT WITH RESPECT TO WHICH THIS CERTIFICATE MAY BE ISSUED OR MAY PERTAIN, THE INSURANCE AFFORDED BY THE POLICIES DESCRIBED HEREIN IS SUBJECT TO ALL THE TERMS, EXCLUSIONS AND CONDITIONS OF SUCH POLICIES. AGGREGATE LIMITS SHOWN MAY HAVE BEEN REDUCED BY PAID CLAIMS.

INSR. LTR.	TYPE OF INSURANCE	POLICY NUMBER	POLICY EFFECTIVE DATE (MM/DD/YY)	POLICY EXPIRATION DATE (MM/DD/YY)	LIMITS
	GENERAL LIABILITY				EACH OCCURRENCE \$ 2,000,000
	COMMERCIAL GENERAL LIABILITY				FIRE DAMAGE (Any one fire) \$
	CLAIMS MADE OCCUR				MED EXP (Any one person) \$
					PERSONAL & ADV INJURY \$
	GEN'L AGGREGATE LIMIT APPLIES PER POLICY PROJECT LOC				GENERAL AGGREGATE \$
					PRODUCTS - COMP/OP AGG \$
	AUTOMOBILE LIABILITY				COMBINED SINGLE LIMIT (Ea accident) \$
	ANY AUTO				BODILY INJURY (Per person) \$
	ALL OWNED AUTOS				BODILY INJURY (Per accident) \$
	SCHEDULED AUTOS				PROPERTY DAMAGE (Per accident) \$
	HIRED AUTOS				
	NON-OWNED AUTOS				
	BROAD FORM				
	GARAGE LIABILITY				AUTO ONLY - EA ACCIDENT \$
	ANY AUTO				OTHER THAN AUTO ONLY EA ACC \$
					AGG \$
	EXCESS LIABILITY				EACH OCCURRENCE \$
	OCCUR CLAIMS MADE				AGGREGATE \$
					\$
	DEDUCTIBLE				\$
	RETENTION \$				\$
	WORKERS COMPENSATION AND EMPLOYERS' LIABILITY				WC STATUTORY LIMITS OTH-ER
					E.L. EACH ACCIDENT \$
					E.L. DISEASE - EA EMPLOYEE \$
					E.L. DISEASE - POLICY LIMIT \$
	OTHER				

SAMPLE

CONDITIONS OF OPERATIONS/LOCATIONS/VEHICLES/EXCLUSIONS ADDED BY ENDORSEMENT/SPECIAL PROVISIONS

1

The Board of Midland County Road Commissioners, the Midland County Road Commission, and their officers, agents and employees, are named as additional insured parties.

CERTIFICATE HOLDER

ADDITIONAL INSURED; INSURER LETTER:

CANCELLATION

2

MIDLAND COUNTY ROAD COMMISSION
2334 NORTH MERIDIAN ROAD
SANFORD MI 48657

SHOULD ANY OF THE ABOVE DESCRIBED POLICIES BE CANCELLED BEFORE THE EXPIRATION DATE THEREOF, THE ISSUING INSURER WILL ENDEAVOR TO MAIL 10 DAYS WRITTEN NOTICE TO THE CERTIFICATE HOLDER NAMED TO THE LEFT, BUT FAILURE TO DO SO SHALL IMPOSE NO OBLIGATION OR LIABILITY OF ANY KIND UPON THE INSURER, ITS AGENTS OR REPRESENTATIVES.

AUTHORIZED REPRESENTATIVE OF CASCADE UNDERWRITERS, INC.

Michigan Department
Of Transportation
2124A (09/13)

PRIME CONTRACTOR BI-WEEKLY STATEMENT OF SUBCONTRACTOR/SUPPLIER PAYMENTS

Portions of the information required in accordance with 49 CFR part 26.37 (as detailed in the prompt payment provisions to monitor the progress of the prime contractor in meeting contractual DBE obligations.)

SEE INSTRUCTIONS ON REVERSE

PRIME CONTRACTOR	CONTRACT ID
------------------	-------------

BI-WEEKLY PERIOD ENDING: _____ PROJECT COMPLETION

SUBCONTRACTOR, DBE SUBCONTRACTOR, DBE TRUCKER, DBE SUPPLIER OR SERVICE PROVIDER	SERVICES/WORK CLASSIFICATION	TOTAL SUB CONTRACT AMOUNT	CUMULATIVE DOLLAR VALUE OF SERVICES COMPLETED	DEDUCTIONS	ACTUAL AMOUNT PAID TO DATE	DBE AUTHORIZED SIGNATURE AT PROJECT COMPLETION ONLY	DATE

As the authorized representative of the above prime contractor, I certify that all payments to non-DBE truckers, and non-DBE suppliers that have performed work or supplied materials to the prime during the reporting period have been made, and I certify that this information is true and accurate.

CONTRACTORS AUTHORIZED REPRESENTATIVE (Signature)	TITLE	DATE
---	-------	------

FOR THE MICHIGAN DEPARTMENT OF TRANSPORTATION USE ONLY

COMMENTS

RESIDENT/PROJECT ENGINEER (Signature)	DATE
---------------------------------------	------

INSTRUCTIONS

PRIME CONTRACTOR or AUTHORIZED REPRESENTATIVE

This statement reports the actual dollar amounts of the project cost earned by and paid to all subcontractors, DBE subcontractors, DBE suppliers, and DBE truckers. Complete and submit to the Resident/Project Engineer on a bi-weekly basis during the course of the project using the MERS database. This submittal is required prior to release of the second and subsequent estimates per FUSP 109(A). A hard copy of this form must also be submitted 30 days after project completion with actual DBE signatures (not using MERS).

For “*Control Section*” and “*Job No.*” Use the numbers assigned by MDOT.

For “*Services/Work Classification*,” report services/work performed by DBE subcontractors, DBE suppliers, DBE truckers, and DBE consultants listed by work classification code. If they are performing work in more than one classification, report the code with the largest dollar value. A list of work classification codes is available at www.michigan.gov/mucp.

For “*Total Subcontract Amount*”, report total amount of the contract between the prime contractor and the subcontractor.

For “*Deductions*”, report deductions made by the prime contractor to the subcontractor’s “*Cumulative Dollar Value of Services Completed*” for bond or other fees, materials, services or equipment provided to the subcontractor according to mutual, prior agreement (documentation of such agreement may be required by MDOT).

For “*Actual Amount Paid to Date*”, report cumulative actual payments made to the subcontractor for services completed.

Provide “*DBE Authorized Signature*” on the project completion report.

Be sure to sign, title and date the project completion report.

MDOT RESIDENT/PROJECT ENGINEER:

Please complete the “*Comments*” area, date and submit within the MERS database within 7 days of receipt from prime. Please complete the “*Comments*” area, sign, date, and fax the **project completion report** only to 517-335-0945 or email to mdot-paymentstatements@michigan.gov within 7 days of receipt from prime.

MDOT Office of Business Development
P.O. Box 30050
Lansing, Michigan 48909
Questions about this form? Call Toll-free, 1866-DBE-1264



**MICHIGAN DEPARTMENT OF ENVIRONMENTAL QUALITY
WATER RESOURCES DIVISION
MINOR PROJECT PERMIT**

Issued To:

Terry Palmer, Midland County Road Commission
2334 N Meridian Rd
Sanford, MI 48657

Permit No.: WRP005659 v.1
Submission No.: 2MW-55XK-BBT8
Site Name: 56 West Shaffer Road, Bliss Drain
Issued: 1/23/2017
Expires: 1/23/2022

This permit is being issued by the Michigan Department of Environmental Quality (MDEQ), Water Resources Division, under the provisions of the Natural Resources and Environmental Protection Act, 1994 PA 451, as amended (NREPA); specifically:

- | | |
|--|---|
| <input checked="" type="checkbox"/> Part 301, Inland Lakes and Streams | <input type="checkbox"/> Part 323, Shorelands Protection and Management |
| <input type="checkbox"/> Part 303, Wetlands Protection | <input type="checkbox"/> Part 325, Great Lakes Submerged Lands |
| <input type="checkbox"/> Part 315, Dam Safety | <input type="checkbox"/> Part 353, Sand Dunes Protection and Management |
| <input type="checkbox"/> Part 31, Water Resources Protection (Floodplain Regulatory Authority) | |

Permission is hereby granted, based on permittee assurance of adherence to State of Michigan requirements and permit conditions, to:

Authorized Activity:

Replace road stream crossing with 22 foot span concrete bridge.

As built plans, and photos of the finished project, must be submitted to this office within 7 days of installation.

All according to permit conditions and information submitted. Contact this office 5 days before work begins at silagyj@michigan.gov or 989-370-1569.

Property Location: Midland County, Local Unit of Government Township,
Town/Range/Section: 16N02W26, Property Tax No.

Authority granted by this permit is subject to the following limitations:

- A. Initiation of any work on the permitted project confirms the permittee's acceptance and agreement to comply with all terms and conditions of this permit.
- B. The permittee, in exercising the authority granted by this permit, shall not cause unlawful pollution as defined by Part 31 of the NREPA.

- C. This permit shall be kept at the site of the work and available for inspection at all times during the duration of the project or until its date of expiration.
- D. All work shall be completed in accordance with the approved plans and specifications submitted with the application and/or plans and specifications attached to this permit.
- E. No attempt shall be made by the permittee to forbid the full and free use by the public of public waters at or adjacent to the structure or work approved.
- F. It is made a requirement of this permit that the permittee give notice to public utilities in accordance with 2013 PA 174 (Act 174) and comply with each of the requirements of Act 174.
- G. This permit does not convey property rights in either real estate or material, nor does it authorize any injury to private property or invasion of public or private rights, nor does it waive the necessity of seeking federal assent, all local permits, or complying with other state statutes.
- H. This permit does not prejudice or limit the right of a riparian owner or other person to institute proceedings in any circuit court of this state when necessary to protect his rights.
- I. Permittee shall notify the MDEQ within one week after the completion of the activity authorized by this permit by completing and forwarding the attached preaddressed postcard to the office addressed thereon.
- J. This permit shall not be assigned or transferred without the written approval of the MDEQ.
- K. Failure to comply with conditions of this permit may subject the permittee to revocation of permit and criminal and/or civil action as cited by the specific state act, federal act, and/or rule under which this permit is granted.
- L. All dredged or excavated materials shall be disposed of in an upland site (outside of floodplains, unless exempt under Part 31 of the NREPA, and wetlands).
- M. In issuing this permit, the MDEQ has relied on the information and data that the permittee has provided in connection with the submitted application for permit. If, subsequent to the issuance of a permit, such information and data prove to be false, incomplete, or inaccurate, the MDEQ may modify, revoke, or suspend the permit, in whole or in part, in accordance with the new information.
- N. The permittee shall indemnify and hold harmless the State of Michigan and its departments, agencies, officials, employees, agents, and representatives for any and all claims or causes of action arising from acts or omissions of the permittee, or employees, agents, or representative of the permittee, undertaken in connection with this permit. The permittee's obligation to indemnify the State of Michigan applies only if the state: (1) provides the permittee or its designated representative written notice of the claim or cause of action within 30 days after it is received by the state, and (2) consents to the permittee's participation in the proceeding on the claim or cause of action. It does not apply to contested case proceedings under the Administrative Procedures Act, 1969 PA 306, as amended, challenging the permit. This permit shall not be construed as an indemnity by the State of Michigan for the benefit of the permittee or any other person.
- O. Noncompliance with these terms and conditions and/or the initiation of other regulated activities not specifically authorized shall be cause for the modification, suspension, or revocation of this permit, in whole or in part. Further, the MDEQ may initiate criminal and/or civil proceedings as may be deemed necessary to correct project deficiencies, protect natural resource values, and secure compliance with statutes.
- P. If any change or deviation from the permitted activity becomes necessary, the permittee shall request, in writing, a revision of the permitted activity from the MDEQ. Such revision request shall include complete documentation supporting the modification and revised plans detailing the proposed modification. Proposed modifications must be approved, in writing, by the MDEQ prior to being implemented.
- Q. This permit may be transferred to another person upon written approval of the MDEQ. The permittee must submit a written request to the MDEQ to transfer the permit to the new owner. The new owner must also submit a written request to the MDEQ to accept transfer. The new owner must agree, in writing, to accept all conditions of the permit. A single letter signed by both parties that includes all of the above information may be provided to the MDEQ. The MDEQ will review the request and, if approved, will provide written notification to the new owner.
- R. Prior to initiating permitted construction, the permittee is required to provide a copy of the permit to the contractor(s) for review. The property owner, contractor(s), and any agent involved in exercising the permit are held responsible to ensure that the project is constructed in accordance with all drawings and specifications. The contractor is required to provide a copy of the permit to all subcontractors doing work authorized by the permit.
- S. Construction must be undertaken and completed during the dry period of the wetland. If the area does not dry out, construction shall be done on equipment mats to prevent compaction of the soil.

- T. Authority granted by this permit does not waive permit requirements under Part 91, Soil Erosion and Sedimentation Control, of the NREPA, or the need to acquire applicable permits from the County Enforcing Agent (CEA).
- U. Authority granted by this permit does not waive permit requirements under the authority of Part 305, Natural Rivers, of the NREPA. A Natural Rivers Zoning Permit may be required for construction, land alteration, streambank stabilization, or vegetation removal along or near a natural river.
- V. The permittee is cautioned that grade changes resulting in increased runoff onto adjacent property is subject to civil damage litigation.
- W. Unless specifically stated in this permit, construction pads, haul roads, temporary structures, or other structural appurtenances to be placed in a wetland or on bottomland of the water body are not authorized and shall not be constructed unless authorized by a separate permit or permit revision granted in accordance with the applicable law.
- X. For projects with potential impacts to fish spawning or migration, no work shall occur within fish spawning or migration timelines (i.e., windows) unless otherwise approved in writing by the Michigan Department of Natural Resources, Fisheries Division.
- Y. Work to be done under authority of this permit is further subject to the following special instructions and specifications:
1. Authority granted by this permit does not waive permit or program requirements under Part 91 of the NREPA or the need to acquire applicable permits from the CEA. To locate the Soil Erosion Program Administrator for your county, visit www.mi.gov/degstormwater and select "Soil Erosion and Sedimentation Control Program" under "Related Links."
 2. The authority to conduct the activity as authorized by this permit is granted solely under the provisions of the governing act as identified above. This permit does not convey, provide, or otherwise imply approval of any other governing act, ordinance, or regulation, nor does it waive the permittee's obligation to acquire any local, county, state, or federal approval or authorization necessary to conduct the activity.
 3. No fill, excess soil, or other material shall be placed in any wetland or surface water area not specifically authorized by this permit, its plans, and specifications.
 4. This permit does not authorize or sanction work that has been completed in violation of applicable federal, state, or local statutes.
 5. The permit placard shall be kept posted at the work site, in a prominent location at all times for the duration of the project, or until permit expiration.
 6. This permit is being issued for the maximum time allowed and no extensions of this permit will be granted. Initiation of the construction work authorized by this permit indicates the permittee's acceptance of this condition. The permit, when signed by the MDEQ, will be for a five-year period beginning on the date of issuance. If the project is not completed by the expiration date, a new permit must be sought.
1. Areas to be protected by riprap shall be cleared of brush and debris. All grades shall be shaped and compacted to the required cross section. Geotextile liner shall be placed on the prepared grades. The riprap installation shall not damage the geotextile liner.
 2. All fill shall consist of clean inert material.
 3. Any alterations to the existing road grade elevations other than that shown on the plans will require prior approval from the Water Resources Division.
 4. All work shall be completed in accordance with plans prepared and the last submission to this office. Said plans are kept on file at the MDEQ's Water Resources Division, Gaylord Field Office.
 5. Authority granted by this permit does not waive compliance requirements under Part 91, Soil Erosion and Sedimentation Control, of the NREPA. Any discharge of sediment into waters of the state and/or off the road right-of-way is a violation of this permit, Part 91, and Part 31,

Water Resources Protection, of the NREPA. A violation of these parts subjects the permittee to potential fines and penalties.

6. This permit does not authorize or sanction work that has been completed in violation of applicable federal, state, or local statutes.
7. The permittee is responsible for acquiring all necessary easements or rights-of-way before commencing any work authorized by this permit. All construction operations relating to or part of this project shall be confined to the existing right-of-way limits or other acquired easements.
8. Temporary soil erosion and sedimentation control measures shall be installed before or upon commencement of the earth change and shall be maintained daily. Temporary soil erosion and sedimentation control measures shall be maintained until permanent soil erosion and sedimentation control measures are in place and the area is stabilized. Permanent soil erosion and sedimentation control measures for all slopes, channels, ditches, or any disturbed area shall be installed within five (5) calendar days after final grading or the final earth change has been completed.
9. All raw areas in uplands resulting from the permitted construction activity shall be effectively stabilized with sod and/or seed and mulch (or other technology specified by this permit or project plans) in a sufficient quantity and manner to prevent erosion and any potential siltation to surface waters or wetlands. Temporary stabilization measures shall be installed before or upon commencement of the permitted activity, and shall be maintained until permanent measures are in place. Permanent measures shall be in place within five (5) days of achieving final grade.
10. All raw earth within 100 feet of a lake, stream, or wetland that is not brought to final stabilization by the end of the active growing season shall be temporarily stabilized with mulch blankets in accordance with the following dates: September 20th for the Upper Peninsula, October 1st for the Lower Peninsula north of US-10, and October 10th for the Lower Peninsula south of US-10.
11. This permit shall be kept posted at the work site, in a prominent location at all times for the duration of the project, or until permit expiration.
12. This permit is being issued for the maximum time allowed and no extensions of this permit will be granted. Initiation of the construction work authorized by this permit indicates the permittee's acceptance of this condition. The permit, when signed by the MDEQ, will be for a five-year period beginning at the date of issuance. If the project is not completed by the expiration date, a new permit must be sought.
13. All slurry resulting from any dewatering operation shall be discharged through a filter bag or pumped to a sump located away from wetlands and surface waters and allowed to filter through natural upland vegetation, gravel filters, or other engineered devices for a sufficient distance and/or period of time necessary to remove sediment or suspended particles. The discharge of slurry water resulting from the hydrodemolition of concrete is not allowed to enter a lake, stream, or wetland.
14. All dredge/excavated spoils including organic and inorganic soils, vegetation, and other material removed shall be placed on upland (non-wetland, non-floodplain or non-bottomland), prepared for stabilization, revegetated and reseeded with native Michigan species appropriate

to the site, and mulched in such a manner so as to prevent and ensure against erosion of any material into any waterbody, wetland, or floodplain.

15. During removal or repair of the existing structure, every precaution shall be taken to prevent debris from entering any watercourse. Any debris reaching the watercourse during the removal and/or reconstruction of the structure shall be immediately retrieved from the water. All material shall be disposed of in an acceptable manner consistent with local, state, and federal regulations.
16. Prior to the removal of the existing structures located in the water or wetland; cofferdams of interlocking steel sheet piling or other acceptable barriers approved in advance by the Engineer shall be installed to isolate all construction activities from the water. The cofferdam shall be maintained in good working order throughout the duration of the project. Upon project completion, the accumulated materials inside the cofferdam shall be removed and disposed of at an upland site.
17. All cofferdam and temporary steel sheet pile shall then be removed in its entirety, unless specifically shown to be left in place on the plans. Cofferdam and sheet pile that are to remain shall be cut off at the elevation shown on the plan. Cofferdam and sheet pile left above the stream bottom must be approved by the DEQ. Areas where the sheet piling is cut off shall be covered with riprap as shown in the plans or backfilled with other acceptable material approved in advance by the Engineer and the DEQ. Projects where the cofferdam is cut off less than 1 foot below the stream bottom must be submitted for individual review before any revision to current permit conditions will be allowed.
18. The existing structure, temporary structure, or permitted structure, shall be kept open to pass the water or stream flow at all times.
19. The placement of the new structure shall be done immediately after removal of the existing structure. The placement shall be conducted in such a manner that all flow is immediately passed through the new structure, allowing the major placement of fill, if a permitted part of this project, to be done in the dry or in still water where erosion and sedimentation will be minimized. The fill material used in this initial placement shall be washed gravel, coarse aggregate, or rock and shall be placed at both ends of the culvert to a level above normal water level before backfill material is placed.
20. The structure shall be installed to align with the center line of the existing stream at both the inlet and outlet ends, and if four sided must be recessed into the stream bed to provide a natural channel substrate throughout the structure, as shown on the approved plans.
21. Road fill side slopes shall not be steeper than 1-on-2 (1 vertical to 2 horizontal) except where headwalls of reinforced concrete, mortar masonry, dry masonry, or other acceptable methods are used.
22. Road fill side slopes terminating in the stream and any raw streambanks resulting from the construction shall be stabilized with temporary measures in accordance with appropriate Best Management Practices based on site conditions, and if necessary, may be riprapped extending above the ordinary high water mark, before or upon commencement of the permitted activity. Temporary stabilization measures shall be maintained until permanent measures are in place.

23. All other road fill slopes, ditches, and other raw areas draining directly to the stream may be protected with riprap, sod and/or seed and mulch as may be necessary to provide effective erosion protection. The placement of riprap shall be limited to the minimum necessary to ensure proper stabilization of the side slopes and fill in the immediate vicinity of the structure.
24. If the project, or any portion of the project, is stopped and lies incomplete for any length of time other than that encountered in a normal work week, every precaution shall be taken to protect the incomplete work from erosion, including the placement of temporary gravel bag riprap, temporary seed and mulch, or other acceptable temporary protection.
25. No work shall be done in the stream during periods of above-normal flows except as necessary to prevent erosion.
26. The use of explosives for removal of the structure over the waterbody, including any abutments or piers, is strictly prohibited.
27. No work or dredging authorized by this permit is allowed from March 16 to May 31 due to critical spawning, migration, and/or recreational use periods. Work isolated from the water, with no sediments entering the watercourse, is permitted

Issued By:



Jeff Silagy
Water Resources Division
989-370-1569

PROGRESS CLAUSE: Shaffer Road over the Bliss Drain

Start work no later than October 16, 2017 after receiving notice of award of contract or on or before the date designated as the starting date in the Detailed Progress Schedule, whichever is later. In no case shall any work commence prior to receipt of formal notice of award by the Department.

Open to Traffic on or before **November 13, 2017**.

The entire Project shall be complete by **June 1, 2018**

The low bidder(s) for the work covered by this proposal will be required to meet with Midland County Road Commission and MDOT representatives to work out a detailed progress schedule. The schedule for this meeting will be set within one week after Notice of Award by Department.

The named subcontractors(s) for Specialty and/or Designated Items (if such items are designated in the proposal), which materially affect the work schedule, shall also be present at the scheduled meeting and they will be required to sign the Progress Schedule to indicate their approval of the scheduled dates of work set forth in the Progress Schedule.

The Project Engineer will arrange the time and place for the meeting.

The Progress Schedule shall include, as a minimum, the starting and completion date for major items, and where specified in the Bidding Proposal the project opened to traffic date, as well as the final project completion date specified in the Bidding Proposal.

If the Bidding Proposal specified other controlling dates, these shall also be included in the Progress Schedule.

Failure on the part of the Contractor to carry out the provisions of the Progress Schedule, as established, may be considered sufficient cause to prevent bidding future projects until a satisfactory rate of progress is again established.

The starting date, contract time, or completion date for this project may be adjusted by the County without imposing liquidated damages upon the receipt of satisfactory documented evidence that unforeseen delayed delivery of critical materials will prevent the orderly prosecution of the work.

MIDLAND COUNTY ROAD COMMISSION

SPECIAL PROVISION
FOR
MAINTENANCE OF TRAFFIC

OHM:CDS

1 of 3

03/16

a. General Requirements. This work shall be in accordance with Sections 103.05 and 812 of the Michigan Department of Transportation (MDOT) 2012 Standard Specifications for Construction including any Supplemental Specifications and Special Provisions, the 2011 Michigan Manual of Uniform Traffic Control Devices (MMUTCD), and as specified in the proposal.

b. Construction Influence Area (CIA). The CIA shall include the Rights-of-Way of the following roadways, within the approximate limits described below:

- At the project location and 200 ft north and south

In addition, the CIA shall include the Rights-of-Way of any other roads intersecting/crossing West River Road for a distance of 100 ft from the point of intersection or crossing.

c. Maintenance of Traffic. Traffic shall be maintained with a detour route by the Contractor throughout the project in accordance with Section 103.05 and 812 of the MDOT 2012 Standard Specifications for Construction, and any supplemental specifications in this proposal.

The Contractor shall, for the safety and protection of through and local traffic, furnish, erect, and maintain traffic control devices as shown on the plans and as directed by the Engineer. The work to be completed is designated in the contract plans, and shall include, but is not limited to, the removal of the existing bridge, construction of the proposed bridge, guardrail, and road construction.

The contractor shall furnish, place, and maintain signs, barricades, lights, arrow panels, and minor traffic control devices along the detour route and within the CIA, and upon completion of the work, remove these items from the project.

The Contractor shall notify the Project Engineer a minimum of 72 business hours prior to the implementation of any lane closures and/or traffic shifts.

Separate pay items are provided in the contract to compensate for the traffic maintenance outlined in this special provision. All other costs due to traffic maintenance are the responsibility of the Contractor.

Refer to the MDOT Maintaining Traffic Typicals WZD-100-A, WZD-125D, M0020a and M0150a. In addition, all construction warning signs shall be prismatic.

Barricades

Barricades and traffic cones necessary for traffic control and public safety shall be furnished and erected by the Contractor as shown on the plans or as directed by the Engineer. The barricades shall be lighted as shown in the MDOT 2012 Standard Specifications for Construction and the 2011 MMUTCD. Any signs required at Type III Barricade locations shall be mounted above the barricade on separate sign supports.

Signing and Traffic Control

The Contractor shall furnish and install all signing necessary for the maintenance of traffic. All signs shall conform to the 2011 MMUTCD.

Cleaning Streets

Dirt, mud, construction materials, or other debris deposited on streets as the result of spilling, tracking on the wheels of trucks or construction equipment, or by other actions of the Contractor, his employees, or his subcontractors shall be immediately removed by the Contractor.

Other Requirements

Permanent pavement markings shall be a part of this contract.

Payment for quantities used to maintain traffic will be based on the maximum number of units required by the Engineer at any one time for the entire project.

Failure to comply with all stipulations of the above traffic specifications may be cause for complete shutdown of the project.

In the event of an emergency, these restrictions are subject to change if traffic conditions indicate such a necessity. At all times on the project during periods of traffic control set up and traffic regulation the Maintenance of Traffic specifications are to be on the person or individual(s) responsible to perform this work for the Contractor.

The Contractor shall be subject to the requirements of the MDOT Special Provision for Traffic Control Quality and Compliance contained in the proposal. If in the opinion of the Engineer, conditions require immediate attention by CCRC forces, the cost of signs, lights, etc. and placement of the same will be charged to the Contractor. In addition, a charge of \$300 per operation shall be assessed to cover coordination and supervision. These charges shall be over and above the price adjustments contained in the MDOT Special Provision for Traffic Control Quality and Compliance.

This applies along with all other restrictions of the Michigan Department of Transportation's holiday work stoppage memorandums.

e. Measurement and Payment. Temporary traffic control items have been set up for maintenance of traffic during construction zone operations and shall be measured and paid for in accordance with Section 812 of the MDOT 2012 Standard Specifications for Construction including any Supplemental Specifications and Special Provisions. Payment for quantities used to maintain traffic will be based on the maximum number of units required by the Engineer at any one time for the entire project.

MINIMUM MERGING TAPER LENGTH "L" (FEET)

OFFSET FEET	POSTED SPEED LIMIT, MPH (PRIOR TO WORK AREA)									
	25	30	35	40	45	50	55	60	65	70
1	10	15	20	27	45	50	55	60	65	70
2	21	30	41	53	90	100	110	120	130	140
3	31	45	61	80	135	150	165	180	195	210
4	42	60	82	107	180	200	220	240	260	280
5	52	75	102	133	225	250	275	300	325	350
6	63	90	123	160	270	300	330	360	390	420
7	73	105	143	187	315	350	385	420	455	490
8	83	120	163	213	360	400	440	480	520	560
9	94	135	184	240	405	450	495	540	585	630
10	104	150	204	267	450	500	550	600	650	700
11	115	165	225	293	495	550	605	660	715	770
12	125	180	245	320	540	600	660	720	780	840
13	135	195	266	347	585	650	715	780	845	910
14	146	210	286	374	630	700	770	840	910	980
15	157	225	307	400	675	750	825	900	975	1050

TAPER LENGTH "L" IN FEET

THE FORMULAS FOR THE MINIMUM LENGTH OF A MERGING TAPER IN DERIVING THE "L" VALUES SHOWN IN THE ABOVE TABLES ARE AS FOLLOWS:

"L" = $\frac{W \times S^2}{60}$ WHERE POSTED SPEED PRIOR TO THE WORK AREA IS 40 MPH OR LESS

"L" = S x W WHERE POSTED SPEED PRIOR TO THE WORK AREA IS 45 MPH OR GREATER

- L = MINIMUM LENGTH OF MERGING TAPER
- S = POSTED SPEED LIMIT IN MPH PRIOR TO WORK AREA
- W = WIDTH OF OFFSET

TYPES OF TAPERS

UPSTREAM TAPERS

- MERGING TAPER
- SHIFTING TAPER
- SHOULDER TAPER
- TWO-WAY TRAFFIC TAPER

DOWNSTREAM TAPERS

(USE IS OPTIONAL)

TAPER LENGTH

- L - MINIMUM
- 1/2 L - MINIMUM
- 1/3 L - MINIMUM
- 100' - MAXIMUM
- 100' - MINIMUM (PER LANE)

 TRAFFIC AND SAFETY MAINTAINING TRAFFIC TYPICAL	TABLES FOR "L", "D" AND "B" VALUES		
	DRAWN BY: CON:AE:djf	JUNE 2006	SHEET
CHECKED BY: BMM	PLAN DATE:	M0020a	1 OF 2
FILE: K:/DGN/TSR/STDS/ENGLISH/MNTTRF/M0020a.dgn		REV.	08/21/2006

DISTANCE BETWEEN TRAFFIC CONTROL DEVICES "D"
AND LENGTH OF LONGITUDINAL BUFFER SPACE ON
"WHERE WORKERS PRESENT" SEQUENCES

"D" DISTANCES	POSTED SPEED LIMIT, MPH (PRIOR TO WORK AREA)									
	25	30	35	40	45	50	55	60	65	70
D (FEET)	250	300	350	400	450	500	550	600	650	700

GUIDELINES FOR LENGTH OF
LONGITUDINAL BUFFER SPACE "B"

SPEED* MPH	LENGTH FEET
20	33
25	50
30	83
35	132
40	181
45	230
50	279
55	329
60	411
65	476
70	542

* POSTED SPEED, OFF PEAK 85TH PERCENTILE SPEED PRIOR TO WORK STARTING, OR THE ANTICIPATED OPERATING SPEED

1 BASED UPON AMERICAN ASSOCIATION OF STATE HIGHWAY AND TRANSPORTATION OFFICIALS (AASHTO) BRAKING DISTANCE PORTION OF STOPPING SIGHT DISTANCE FOR WET AND LEVEL PAVEMENTS (A POLICY ON GEOMETRIC DESIGN OF HIGHWAY AND STREETS), AASHTO. THIS AASHTO DOCUMENT ALSO RECOMMENDS ADJUSTMENTS FOR THE EFFECT OF GRADE ON STOPPING AND VARIATION FOR TRUCKS.

 TRAFFIC AND SAFETY MAINTAINING TRAFFIC TYPICAL	TABLES FOR "L", "D" AND "B" VALUES		
	DRAWN BY: CON:AE:djf CHECKED BY: BMM	JUNE 2006 PLAN DATE:	M0020a
FILE: K:/DGN/TSR/STDS/ENGLISH/MNTTRF/M0020a.dgn REV. 08/21/2006			





PLACE THROUGHOUT WORK AREA AS INDICATED AND AFTER ALL MAJOR CROSSROADS IF PERMANENT SIGNS ARE NOT IN PLACE.

PLACE THIS SIGN ALONG WITH THE ADVANCE WORK ZONE SIGNING AS DEPICTED ON THE APPROPRIATE TYPICAL M0030a-M0080a.

PLACE THROUGHOUT WORK AREA AS INDICATED AND AFTER ALL MAJOR CROSSROADS IF PERMANENT SIGNS ARE NOT IN PLACE.

PLACE THIS SIGN ALONG WITH THE ADVANCE WORK ZONE SIGNING AS DEPICTED ON THE APPROPRIATE TYPICAL M0030a-M0080a.

KEY

-  TRAFFIC REGULATOR
-  CHANNELIZING DEVICES
-  LIGHTED ARROW PANEL (CAUTION MODE)
-  TRAFFIC FLOW
-  REFLECTS EXISTING SPEED LIMIT

SIGN = 200 ft± - TYPE B PLUS ADDITIONAL R2-1's THROUGHOUT WORK AREA

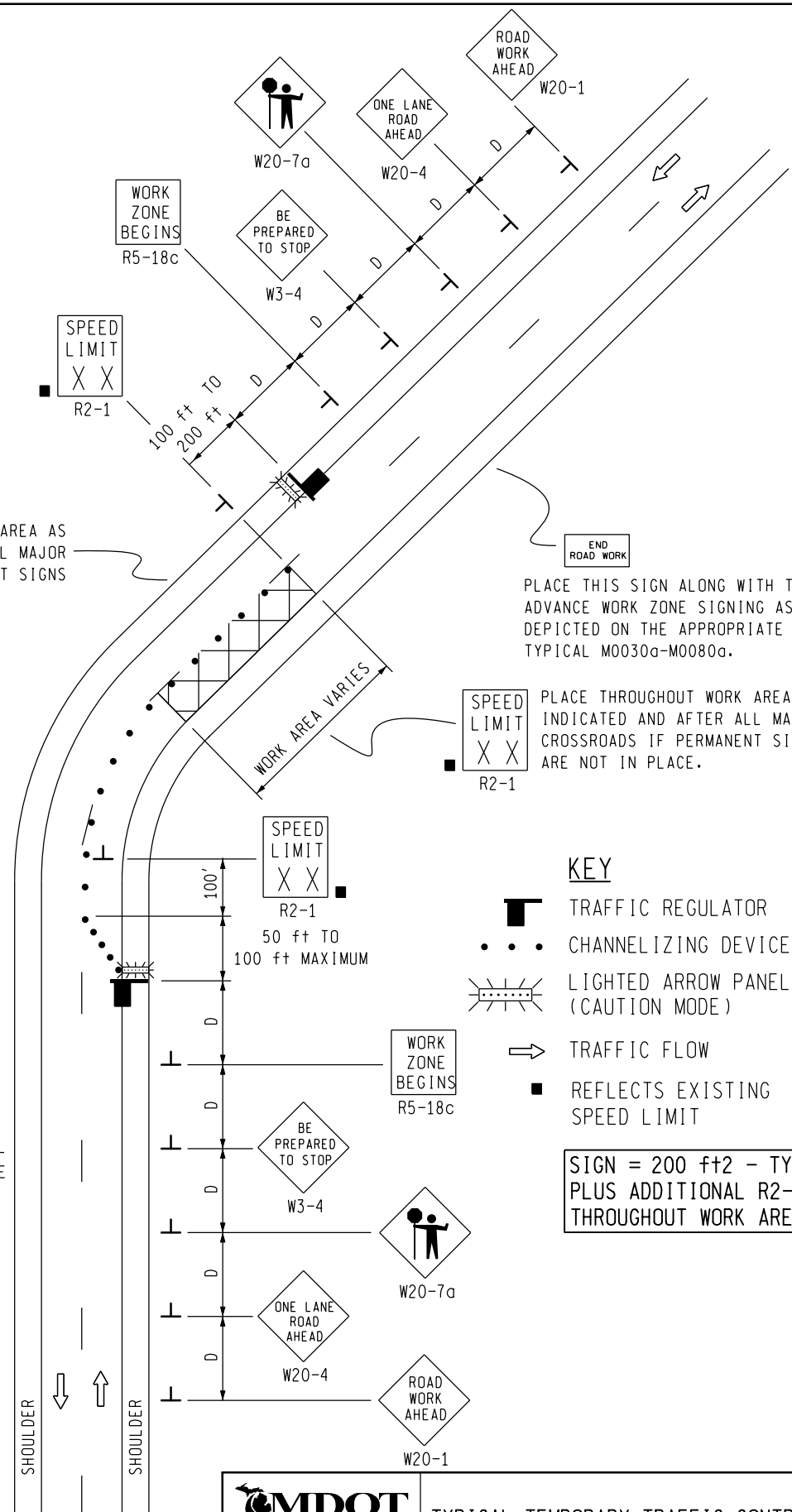

NOT TO SCALE

 Michigan Department of Transportation TRAFFIC AND SAFETY MAINTAINING TRAFFIC TYPICAL		TYPICAL TEMPORARY TRAFFIC CONTROL FOR A TWO-LANE TWO-WAY ROADWAY WHERE ONE LANE IS CLOSED UTILIZING TRAFFIC REGULATORS, NO SPEED REDUCTION	
DRAWN BY: CON:AE:djf CHECKED BY: BMM:CRB	OCTOBER 2011 PLAN DATE:	M0140a	SHEET 1 OF 2
FILE: PW RD/TS/Typicals/Signs/MT NON Fwy/M0140a.dgn REV. 10/04/2011			

NOTES

- 1H. D = DISTANCE BETWEEN TRAFFIC CONTROL DEVICES AND LENGTH OF LONGITUDINAL BUFFERS
SEE **M0020a** FOR "D" VALUES.
2. ALL NON-APPLICABLE SIGNING WITHIN THE CIA SHALL BE MODIFIED TO FIT CONDITIONS, COVERED OR REMOVED.
3. DISTANCES BETWEEN SIGNS, THE VALUES FOR WHICH ARE SHOWN IN TABLE D, ARE APPROXIMATE AND MAY NEED ADJUSTING AS DIRECTED BY THE ENGINEER.
- 3A. THE "WORK ZONE BEGINS" (R5-18c) SIGN SHALL BE USED ONLY IN THE INITIAL SIGNING SEQUENCE IN THE WORK ZONE. SUBSEQUENT SEQUENCES IN THE SAME WORK ZONE SHALL OMIT THIS SIGN AND THE QUANTITIES SHALL BE ADJUSTED APPROPRIATELY.
- 4A. THE MAXIMUM RECOMMENDED DISTANCE(S) BETWEEN CHANNELIZING DEVICES IN THE TAPER AREA(S) SHOULD BE 15 FEET AND SHOULD BE EQUAL IN FEET TO TWICE THE POSTED SPEED IN MILES PER HOUR IN THE PARALLEL AREA(S).
5. FOR OVERNIGHT CLOSURES, TYPE III BARRICADES SHALL BE LIGHTED.
6. WHEN CALLED FOR IN THE FHWA ACCEPTANCE LETTER FOR THE SIGN SYSTEM SELECTED, THE TYPE A WARNING FLASHER, SHOWN ON THE WARNING SIGNS, SHALL BE POSITIONED ON THE SIDE OF THE SIGN NEAREST THE ROADWAY.
7. ALL TEMPORARY SIGNS, TYPE III BARRICADES, THEIR SUPPORT SYSTEMS AND LIGHTING REQUIREMENTS SHALL MEET NCHRP 350 CRASHWORTHLY REQUIREMENTS STIPULATED IN THE CURRENT EDITION OF THE MICHIGAN MANUAL ON UNIFORM TRAFFIC CONTROL DEVICES, THE CURRENT EDITION OF THE STANDARD SPECIFICATIONS FOR CONSTRUCTION, THE STANDARD PLANS AND APPLICABLE SPECIAL PROVISIONS. ONLY DESIGNS AND MATERIALS APPROVED BY MDOT WILL BE ALLOWED.
9. ALL TRAFFIC REGULATORS SHALL BE PROPERLY TRAINED AND SUPERVISED.
- 9A. IN ANY OPERATION INVOLVING MORE THAN ONE TRAFFIC REGULATOR, ONE PERSON SHOULD BE DESIGNATED AS HEAD TRAFFIC REGULATOR.
10. ALL TRAFFIC REGULATORS' CONDUCT, THEIR EQUIPMENT, AND TRAFFIC REGULATING PROCEDURES SHALL CONFORM TO THE CURRENT EDITION OF THE MICHIGAN MANUAL OF UNIFORM TRAFFIC CONTROL DEVICES (MMUTCD) AND THE CURRENT EDITION OF THE MDOT HANDBOOK ENTITLED "TRAFFIC REGULATORS INSTRUCTION MANUAL."
11. WHEN TRAFFIC REGULATING IS ALLOWED DURING THE HOURS OF DARKNESS, APPROPRIATE LIGHTING SHALL BE PROVIDED TO SUFFICIENTLY ILLUMINATE THE TRAFFIC REGULATOR'S STATIONS.
- 12E. THE MAXIMUM DISTANCE BETWEEN THE TRAFFIC REGULATORS SHALL BE NO MORE THAN 2 MILES IN LENGTH UNLESS RESTRICTED FURTHER IN THE SPECIAL PROVISIONS FOR MAINTAINING TRAFFIC. ALL SEQUENCES OF MORE THAN 2 MILES IN LENGTH WILL REQUIRE WRITTEN PERMISSION FROM THE ENGINEER BEFORE PROCEEDING.
13. WHEN INTERSECTING ROADS OR SIGNIFICANT TRAFFIC GENERATORS (SHOPPING CENTERS, MOBILE HOME PARKS, ETC.) OCCUR WITHIN THE ONE-LANE TWO-WAY OPERATION, INTERMEDIATE TRAFFIC REGULATORS AND APPROPRIATE SIGNING SHALL BE PLACED AT THESE LOCATIONS.
14. ADDITIONAL SIGNING AND/OR ELONGATED SIGNING SEQUENCES SHOULD BE USED WHEN TRAFFIC VOLUMES ARE SIGNIFICANT ENOUGH TO CREATE BACKUPS BEYOND THE W3-4 SIGNS.
15. THE HAND HELD (PADDLE) SIGNS REQUIRED BY THE MMUTCD TO CONTROL TRAFFIC WILL BE PAID FOR AS PART OF FLAG CONTROL.
- 28E. THE TRAFFIC REGULATORS SHOULD BE POSITIONED AT OR NEAR THE SIDE OF THE ROAD SO THAT THEY ARE SEEN CLEARLY AT A MINIMUM DISTANCE OF 500 FEET. THIS MAY REQUIRE EXTENDING THE BEGINNING OF THE LANE CLOSURE TO OVERCOME VIEWING PROBLEMS CAUSED BY HILLS AND CURVES.

SIGN SIZES

DIAMOND WARNING - 48" x 48"
 R2-1 REGULATORY - 48" x 60"
 R5-18c REGULATORY - 48" x 48"

NOT TO SCALE

 TRAFFIC AND SAFETY MAINTAINING TRAFFIC TYPICAL	TYPICAL TEMPORARY TRAFFIC CONTROL FOR A TWO-LANE TWO-WAY ROADWAY WHERE ONE LANE IS CLOSED UTILIZING TRAFFIC REGULATORS, NO SPEED REDUCTION		
DRAWN BY: CON:AE:djf	OCTOBER 2011	M0140a	SHEET
CHECKED BY: BMM:CRB	PLAN DATE:		2 OF 2
FILE: PW RD/TS/Typicals/Signs/MT NON FWY/M0140a.dgn REV. 10/04/2011			

SIGN MATERIAL SELECTION TABLE

SIGN SIZE	SIGN MATERIAL TYPE		
	TYPE I	TYPE II	TYPE III
≤ 36" X 36"		X	X
>36" X 36" < 96" TO WIDE		X	
> 96" WIDE TO 144" WIDE	X	X	
> 144" WIDE	X		

TYPE I ALUMINUM EXTRUSION
 TYPE II PLYWOOD
 TYPE III ALUMINUM SHEET

ROUNDING OF CORNERS IS NOT REQUIRED FOR TYPE I OR II SIGNS.
 VERTICAL JOINTS ARE NOT PERMITTED.
 HORIZONTAL JOINTS THROUGH SIGN LEGEND OR SYMBOLS ARE NOT PERMITTED.

POST SIZE REQUIREMENTS TABLE

SIGN AREA (ft ²)	POST TYPE		
	U-CHANNEL STEEL	SQUARE TUBULAR STEEL	WOOD
≤9	1 - 3 lb/ft*	1 - 2" 12 or 14 GA*	N/A
9 ≤ 20	2 - 3 lb/ft	2 - 2" 12 or 14 GA	1 - 4" X 6"*
> 20 ≤ 30	N/A	N/A	2 - 4" X 6"
> 30 ≤ 60	N/A	N/A	2 - 6" X 8"
> 60 ≤ 84	N/A	N/A	3 - 6" X 8"

*SIGNS 4 FEET AND GREATER IN WIDTH REQUIRE 2 POSTS.
 SIGNS GREATER THAN 8 FEET IN WIDTH REQUIRE 2 OR 3 WOOD
 POSTS DEPENDING ON AREA OF SIGN.
 A MAXIMUM OF 2 POSTS WITHIN A 7' PATH IS PERMITTED.

 PREPARED BY OPERATIONS FIELD SERVICES	DEPARTMENT DIRECTOR Kirk T. Steudle APPROVED BY: _____ DIRECTOR, BUREAU OF FIELD SERVICES	MICHIGAN DEPARTMENT OF TRANSPORTATION BUREAU OF FIELD SERVICES SPECIAL DETAIL FOR GROUND DRIVEN SIGN SUPPORTS FOR TEMP SIGNS		
	DRAWN BY: <u>CON/ECH</u> CHECKED BY: <u>AUG</u>	APPROVED BY: _____ DIRECTOR, BUREAU OF HIGHWAY DEVELOPMENT	F.H.W.A. APPROVAL	<u>7/20/2016</u> PLAN DATE

2 POST SIGN SUPPORT SPACING

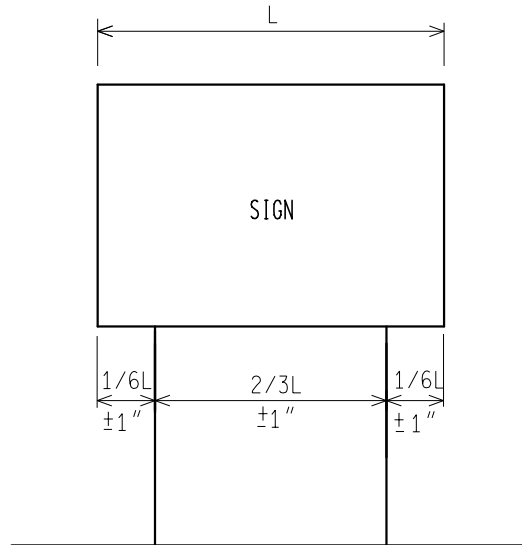

3 POST SIGN SUPPORT SPACING

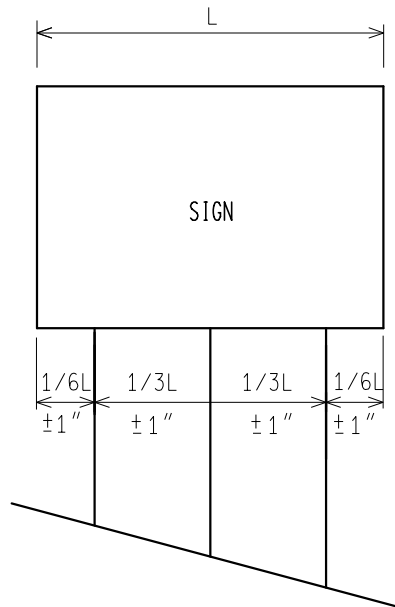

* FOR ALL 11' AND 12' LONG SIGNS ON 3 WOOD SUPPORTS, SPREAD POSTS SO AS TO HAVE A 8' MIN. TO 9' MAX. DISTANCE BETWEEN OUTSIDE POSTS.

NOT TO SCALE

MICHIGAN DEPARTMENT OF TRANSPORTATION
BUREAU OF FIELD SERVICES SPECIAL DETAIL

F.H.W.A. APPROVAL

7/20/2016
PLAN DATE

WZD-100-A

SHEET
2 OF 11

NOTE: THE ORIGINAL SIGNED COPY IS KEPT ON FILE AT THE MICHIGAN DEPARTMENT OF TRANSPORTATION.

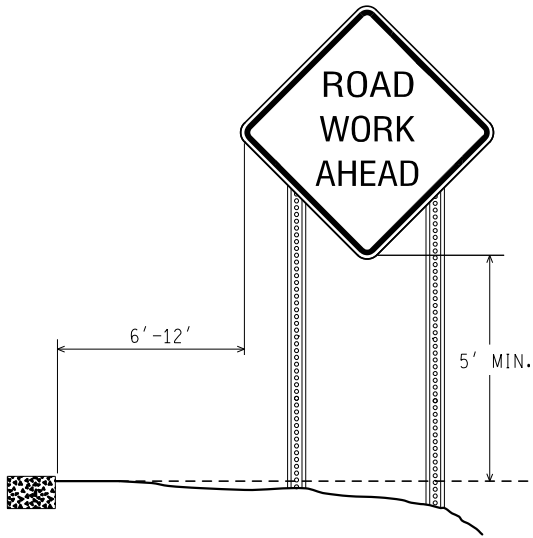

RURAL

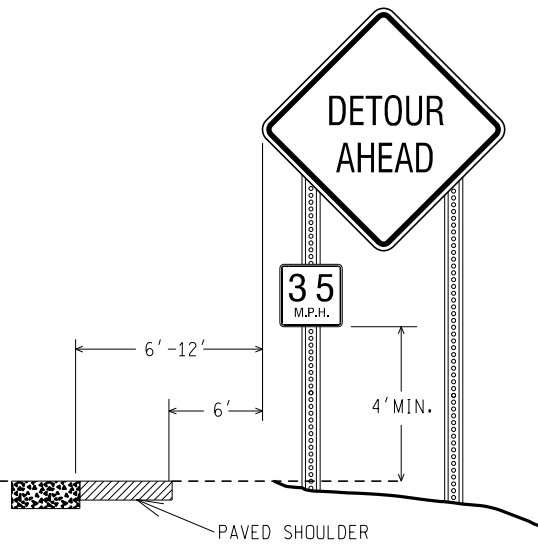

RURAL WITH ADVISORY SPEED PLATE

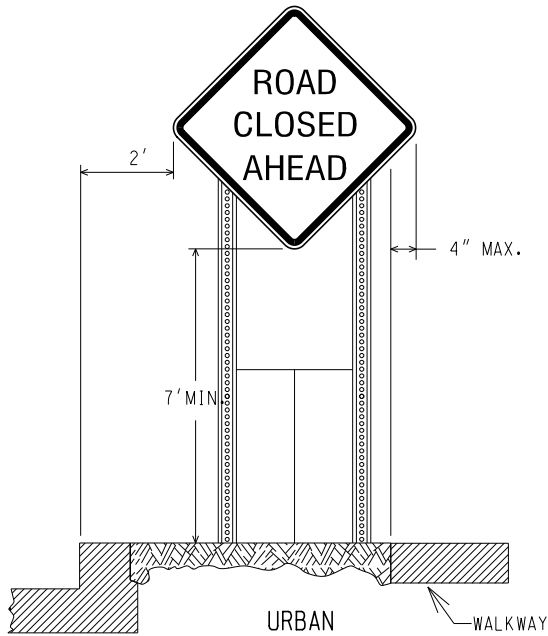

URBAN

(CURBED AREAS OR WHERE WALKWAYS ARE PRESENT)

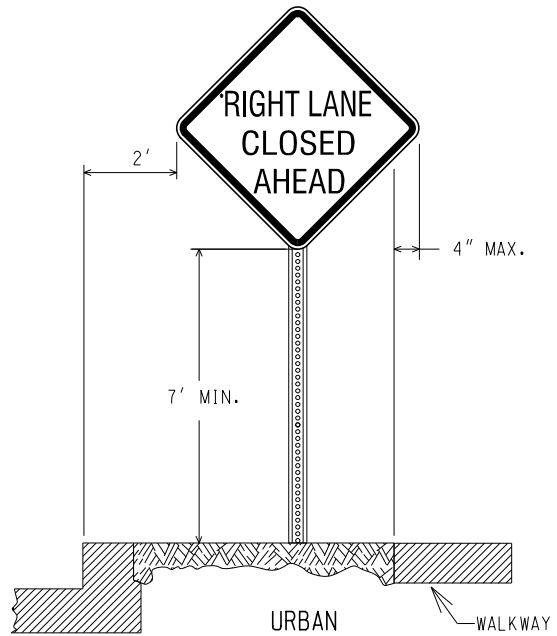

URBAN

(CURBED AREAS OR WHERE WALKWAYS ARE PRESENT)

BOTTOM HEIGHT AND OFFSET

NOT TO SCALE

MICHIGAN DEPARTMENT OF TRANSPORTATION
BUREAU OF FIELD SERVICES SPECIAL DETAIL

F.H.W.A. APPROVAL

7/20/2016
PLAN DATE

WZD-100-A

SHEET
3 OF 11

NOTE: THE ORIGINAL SIGNED COPY IS KEPT ON FILE AT THE MICHIGAN DEPARTMENT OF TRANSPORTATION.

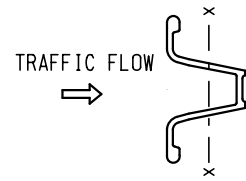
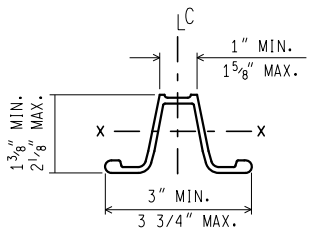
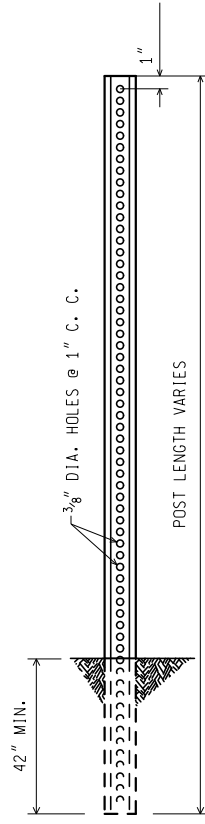

WEIGHT = 3 lbs/ft
 SECT. MOD. X.-X. = 0.31 CUBIC INCHES MIN.

3 lb. U - CHANNEL STEEL POST
 (NO SPLICE)

MOUNT SIGN ON OPEN FACE OF
 U - CHANNEL STEEL POST

NOT TO SCALE

MICHIGAN DEPARTMENT OF TRANSPORTATION BUREAU OF FIELD SERVICES SPECIAL DETAIL	F.H.W.A. APPROVAL	7/20/2016 PLAN DATE	WZD-100-A	SHEET 4 OF 11
--	-------------------	------------------------	-----------	------------------

NOTE: THE ORIGINAL SIGNED COPY IS KEPT ON FILE AT THE MICHIGAN DEPARTMENT OF TRANSPORTATION.

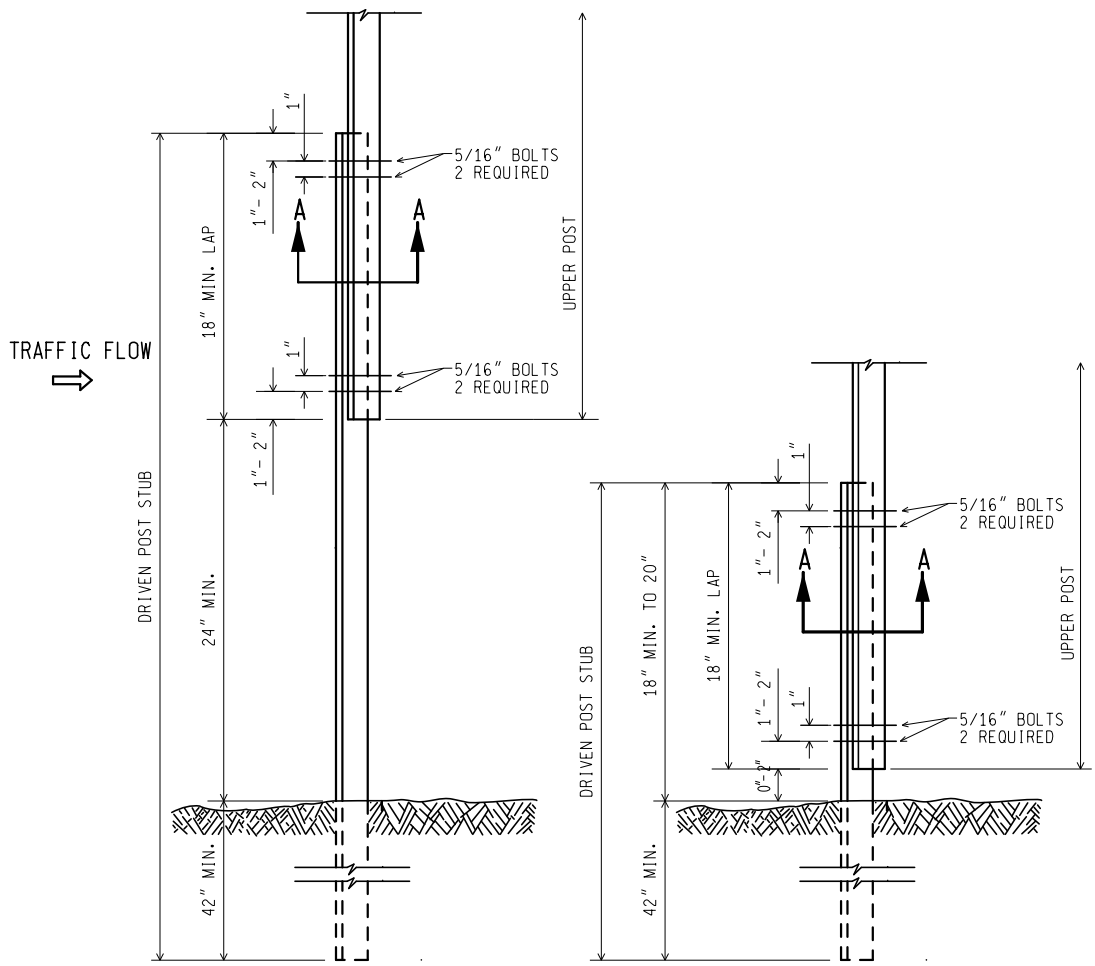

UPPER SPLICE

LOWER SPLICE

3 lb. U - CHANNEL STEEL POST
(WITH SPLICE)

MOUNT SIGN ON OPEN FACE OF
UPPER U - CHANNEL STEEL POST

NOT TO SCALE

MICHIGAN DEPARTMENT OF TRANSPORTATION BUREAU OF FIELD SERVICES SPECIAL DETAIL	F.H.W.A. APPROVAL	7/20/2016 PLAN DATE	WZD-100-A	SHEET 5 OF 11
--	-------------------	------------------------	-----------	------------------

NOTE: THE ORIGINAL SIGNED COPY IS KEPT ON FILE AT THE MICHIGAN DEPARTMENT OF TRANSPORTATION.

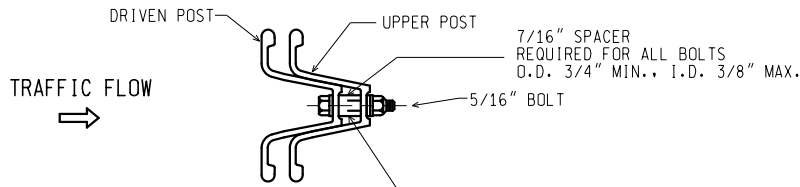

SECTION A-A

7/16" SPACER
 REQUIRED FOR ALL BOLTS
 O.D. 3/4" MIN., I.D. 3/8" MAX.

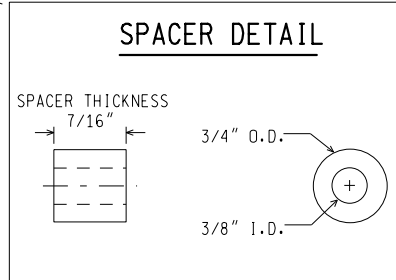

NOTES:

1. THE SPACER THICKNESS SHALL BE 1/16" LESS THAN THE GAP BETWEEN THE POST WHEN POSITIONED IN THE UNBOLTED CONFIGURATION.
2. THE EXTERIOR BOLT (CLOSEST TO LAP), SPACER, WASHER, AND NUT SHALL BE INSTALLED IN A PREPUNCHED HOLE 1" TO 2" FROM THE END OF THE LAP.
3. THE INTERIOR BOLT (FARTHEST FROM LAP), SPACER, WASHER, AND NUT SHALL BE INSTALLED IN THE NEXT PREPUNCHED HOLE.
4. THE DRIVEN POST SHALL ALWAYS BE MOUNTED IN FRONT OF THE UPPER POST WITH RESPECT TO THE ADJACENT ONCOMING TRAFFIC, REGARDLESS OF THE DIRECTION THE SIGN IS FACING.
5. THE SPLICE LAP SHALL BE FASTENED BY FOUR-5/16" DIA. GALVANIZED A449 BOLTS (SAE J429 GRADE 5) OR GALVANIZED A325 BOLTS.

3 lb. U - CHANNEL STEEL POST
 (WITH SPLICE)

NOT TO SCALE

MICHIGAN DEPARTMENT OF TRANSPORTATION BUREAU OF FIELD SERVICES SPECIAL DETAIL	F.H.W.A. APPROVAL	7/20/2016 PLAN DATE	WZD-100-A	SHEET 6 OF 11
--	-------------------	------------------------	-----------	------------------

NOTE: THE ORIGINAL SIGNED COPY IS KEPT ON FILE AT THE MICHIGAN DEPARTMENT OF TRANSPORTATION.

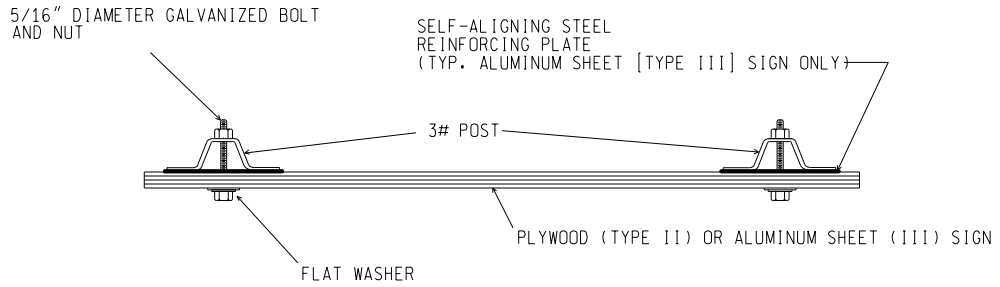

SIGN TO 3 lb. POST CONNECTION

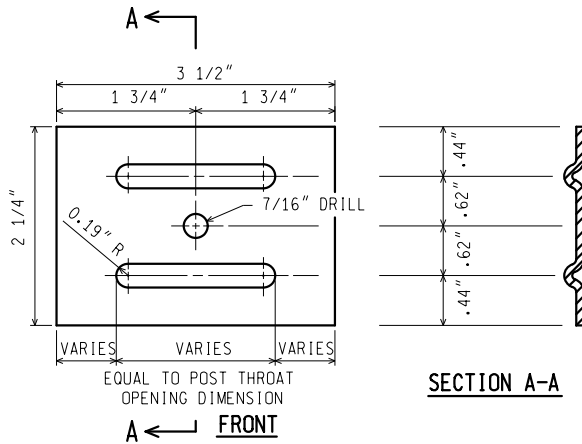

NOTES: (FOR STEEL SIGN REINF' PLATE)

1. MATERIAL: 12 GAUGE CARBON STEEL.
2. TOLERANCE ON ALL DIMENSIONS $\pm 0.0625"$
3. FINISH-AFTER STAMPING AND PUNCHING, GALVANIZE ACCORDING TO CURRENT SPECIFICATIONS FOR ZINC (HOT GALVANIZE) COATINGS ON PRODUCTS FABRICATED FROM PLATES OR STRIPS

STEEL SIGN REINFORCING PLATE
REQUIRED FOR TYPE III SIGNS ONLY

3 lb. U - CHANNEL STEEL POST SIGN CONNECTION

NOT TO SCALE

MICHIGAN DEPARTMENT OF TRANSPORTATION
 BUREAU OF FIELD SERVICES SPECIAL DETAIL

F.H.W.A. APPROVAL

7/20/2016
 PLAN DATE

WZD-100-A

SHEET
 7 OF 11

NOTE: THE ORIGINAL SIGNED COPY IS KEPT ON FILE AT THE MICHIGAN DEPARTMENT OF TRANSPORTATION.

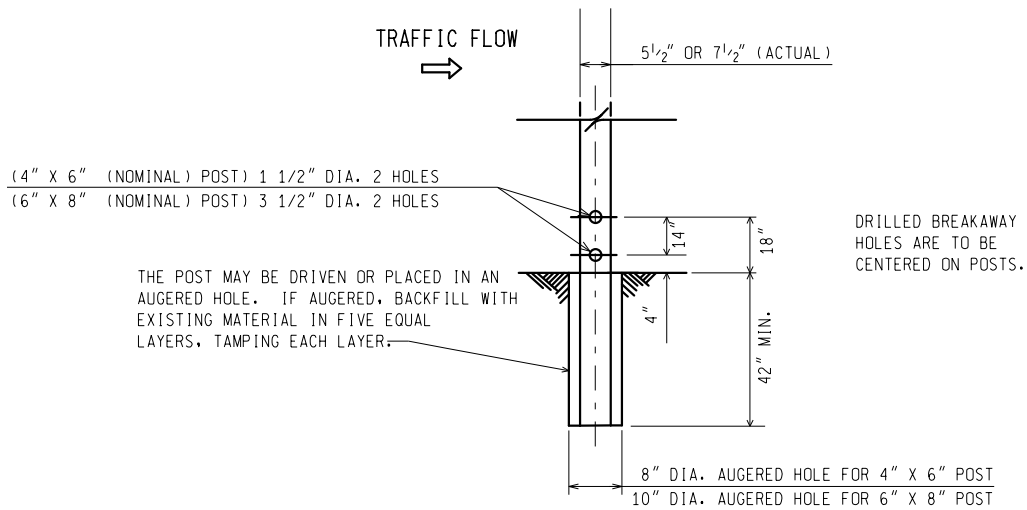

WOOD POST BREAKAWAY HOLES/
 DIRECT EMBEDMENT DETAILS

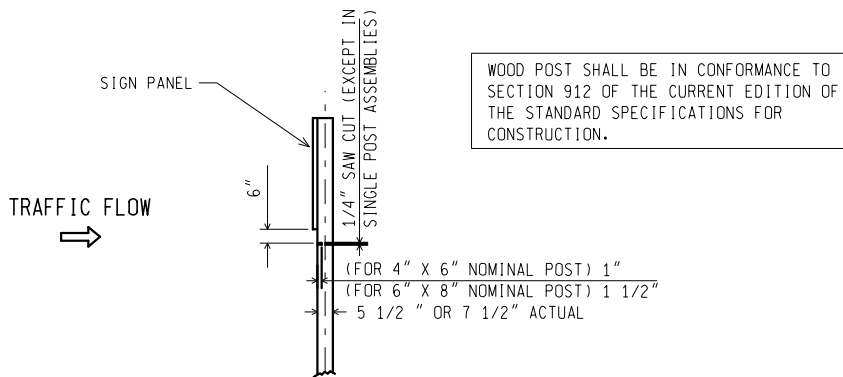

SAW CUT DETAIL
 (MULTIPLE POST INSTALLATIONS)

WOOD POST DETAILS

NOT TO SCALE

MICHIGAN DEPARTMENT OF TRANSPORTATION
 BUREAU OF FIELD SERVICES SPECIAL DETAIL

F.H.W.A. APPROVAL

7/20/2016
 PLAN DATE

WZD-100-A

SHEET
 8 OF 11

NOTE: THE ORIGINAL SIGNED COPY IS KEPT ON FILE AT THE MICHIGAN DEPARTMENT OF TRANSPORTATION.

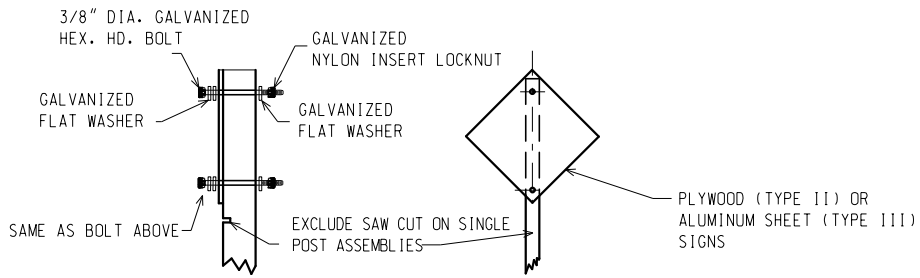

TYPE II AND TYPE III SIGNS

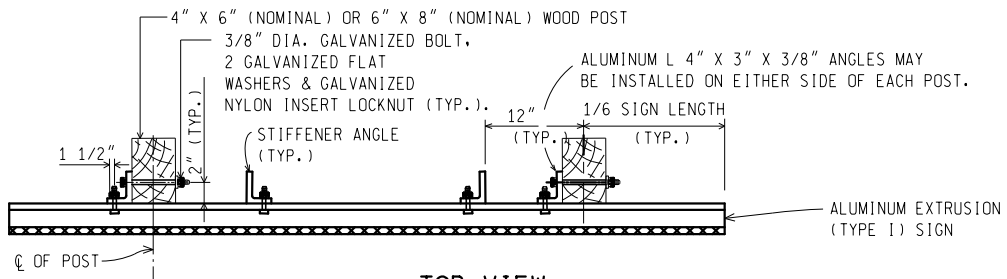

**TOP VIEW
 TYPE I SIGN**

3/8" DIA. GALVANIZED BOLTS
 ON APPROX. 24" CENTERS FULL
 LENGTH ALL EXTRUSIONS.

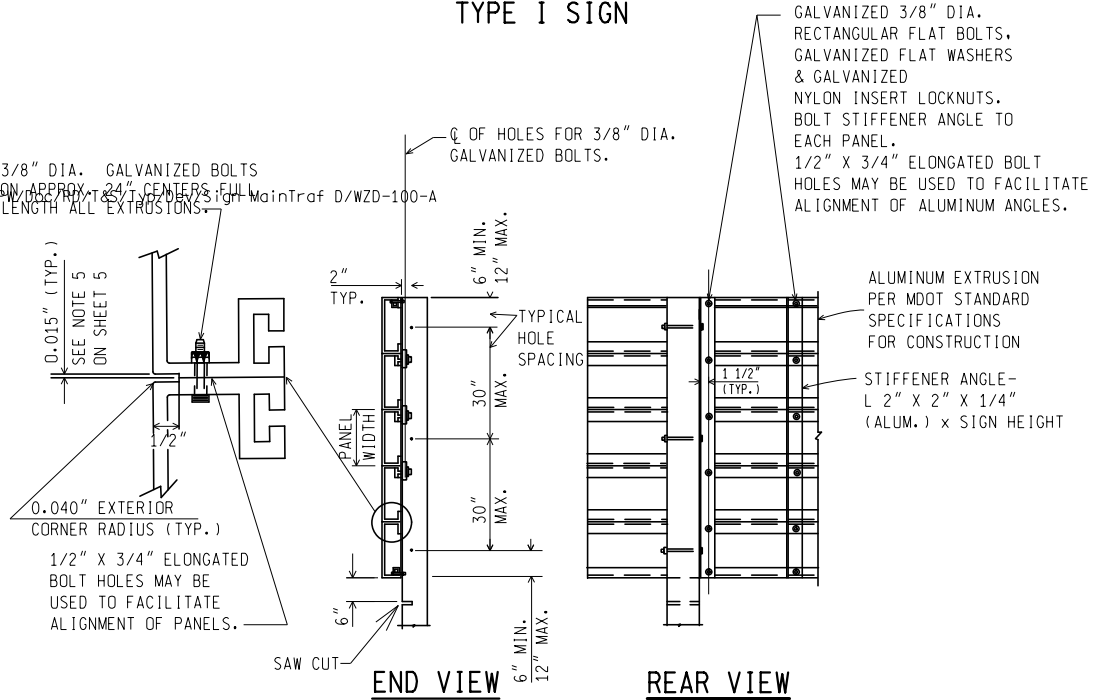

TYPE I SIGN - ERECTION DETAILS

WOOD POST CONNECTIONS

NOT TO SCALE

MICHIGAN DEPARTMENT OF TRANSPORTATION
 BUREAU OF FIELD SERVICES SPECIAL DETAIL

F.H.W.A. APPROVAL

7/20/2016
 PLAN DATE

WZD-100-A

SHEET
 9 OF 11

NOTE: THE ORIGINAL SIGNED COPY IS KEPT ON FILE AT THE MICHIGAN DEPARTMENT OF TRANSPORTATION.

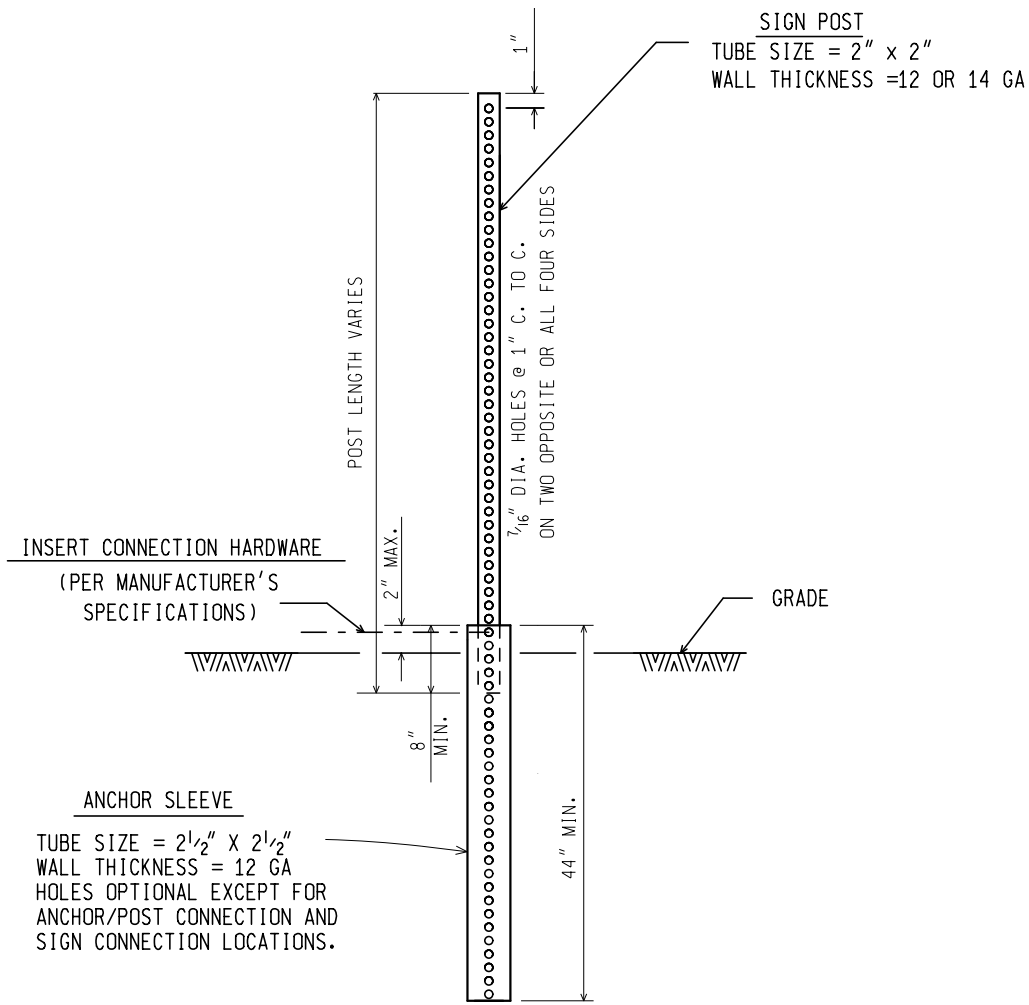

SQUARE TUBULAR STEEL POST

NOT TO SCALE

MICHIGAN DEPARTMENT OF TRANSPORTATION BUREAU OF FIELD SERVICES SPECIAL DETAIL	F.H.W.A. APPROVAL	7/20/2016 PLAN DATE	WZD-100-A	SHEET 10 OF 11
--	-------------------	------------------------	-----------	-------------------

NOTE: THE ORIGINAL SIGNED COPY IS KEPT ON FILE AT THE MICHIGAN DEPARTMENT OF TRANSPORTATION.

GENERAL NOTES:

1. A MAXIMUM OF TWO POSTS WITHIN A 7 FOOT PATH IS PERMITTED.
2. ALL SIGN POSTS SHALL COMPLY WITH NCHRP 350.
3. ALL POSTS SHALL BE EMBEDDED A MINIMUM OF 42".
4. BRACING OF POST IS NOT PERMITTED.
5. SIGN SHALL BE LEVEL, AND UPRIGHT FOR THE DURATION OF INSTALLATION.
6. ERECT POSTS SO THE SIGN FACE AND SUPPORTS DO NOT VARY FROM PLUMB BY MORE THAN 3/16" IN 3'. PROVIDE A CENTER-TO-CENTER DISTANCE BETWEEN POSTS WITHIN 2 PERCENT OF PLAN DISTANCE.
7. NO MORE THAN ONE SPLICE PER POST, AS SHOWN, WILL BE PERMITTED.
8. POST TYPES SHALL NOT BE MIXED WITHIN A SIGN SUPPORT INSTALLATION.
9. NO VERTICAL JOINTS ARE PERMITTED IN SIGN. NO HORIZONTAL JOINTS THROUGH SIGN LEGEND OR SYMBOLS ARE PERMITTED IN SIGN
10. REMOVE SIGN POSTS AND/OR POST STUBS IN THEIR ENTIRETY WHEN NO LONGER REQUIRED.
11. ALL LABOR, MATERIALS, AND EQUIPMENT, INCLUDING TEMPORARY SUPPORTS REQUIRED TO INSTALL, MAINTAIN, RELOCATE, AND/OR REMOVE THE TEMPORARY SIGN, INCLUDING SUPPORTS, ARE CONSIDERED TO BE INCLUDED IN THE COST OF THE TEMPORARY SIGN.
12. SAW CUTS IN WOOD POSTS ARE TO BE PARALLEL TO THE BOTTOM OF THE SIGN.
13. POSTS SHALL NOT EXTEND MORE THAN 4" ABOVE TOP OF SIGN.
14. TEMPORARY WOOD SUPPORTS DO NOT REQUIRE PRESERVATIVE TREATMENT.

NOT TO SCALE

MICHIGAN DEPARTMENT OF TRANSPORTATION BUREAU OF FIELD SERVICES SPECIAL DETAIL	F.H.W.A. APPROVAL	7/20/2016 PLAN DATE	WZD-100-A	SHEET 11 OF 11
--	-------------------	------------------------	-----------	-------------------

NOTE: THE ORIGINAL SIGNED COPY IS KEPT ON FILE AT THE MICHIGAN DEPARTMENT OF TRANSPORTATION.

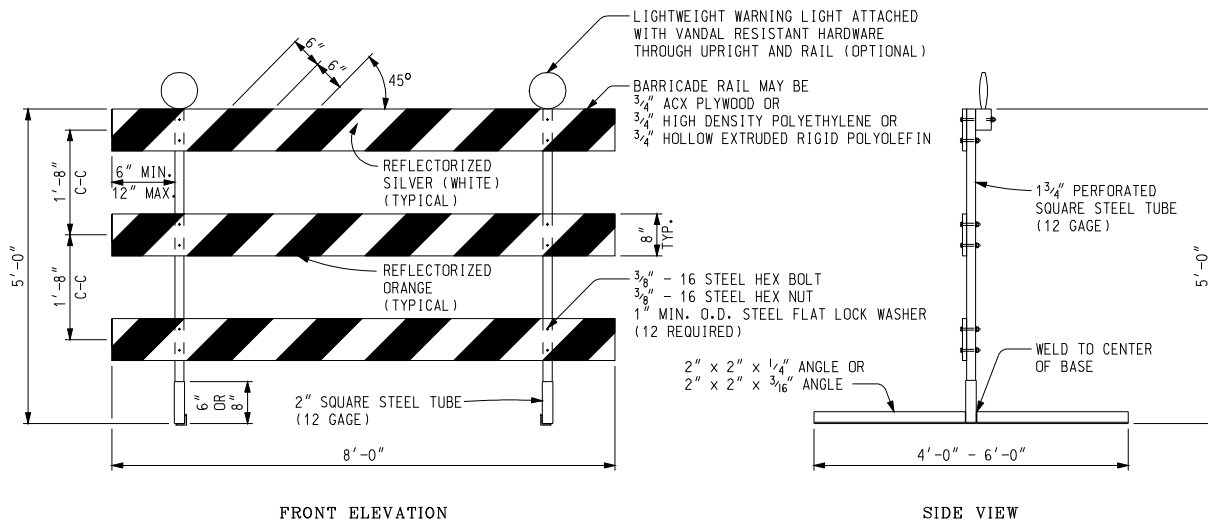

FRONT ELEVATION

SIDE VIEW

PERFORATED SQUARE STEEL TUBE OPTION

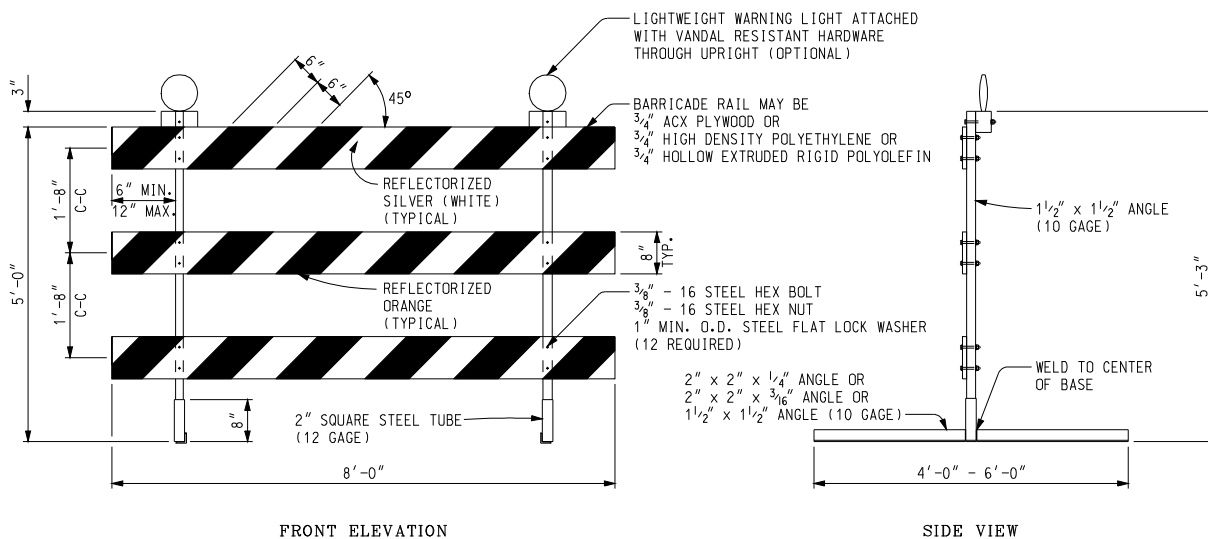

FRONT ELEVATION

SIDE VIEW

ANGLE IRON OPTION

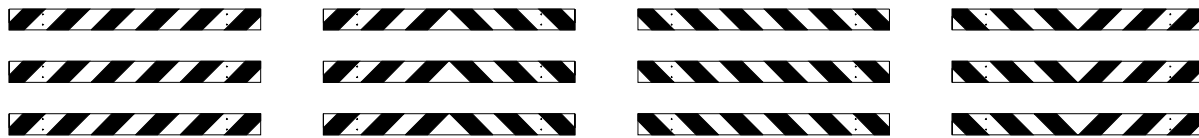

LEFT DIRECTIONAL

BI-DIRECTIONAL

RIGHT DIRECTIONAL

CLOSURES

BARRICADE RAIL SHEETING OPTIONS
TYPE III BARRICADES

Other Type III Barricades meeting current NCHRP crash worthy criteria can be found on the FHWA Safety website at http://safety.fhwa.dot.gov/roadway_dept/road_hardware/wzd.htm

NOT TO SCALE

File: T&S/Typ/Signs/WorkZones/wzd 125 d

Rev. 09/22/09 PJ



PREPARED BY
TRAFFIC AND SAFETY

ENGINEER OF DELIVERY

ENGINEER OF DEVELOPMENT

(SPECIAL DETAIL)

FHWA APPROVAL DATE

MICHIGAN DEPARTMENT OF TRANSPORTATION
BUREAU OF HIGHWAYS DELIVERY STANDARD PLAN FOR

Temporary
Traffic Control Devices

9/22/09
PLAN DATE

WZD-125-E

SHEET
1 of 3

NOTE: THE ORIGINAL SIGNED COPY IS KEPT ON FILE AT THE MICHIGAN DEPARTMENT OF TRANSPORTATION.

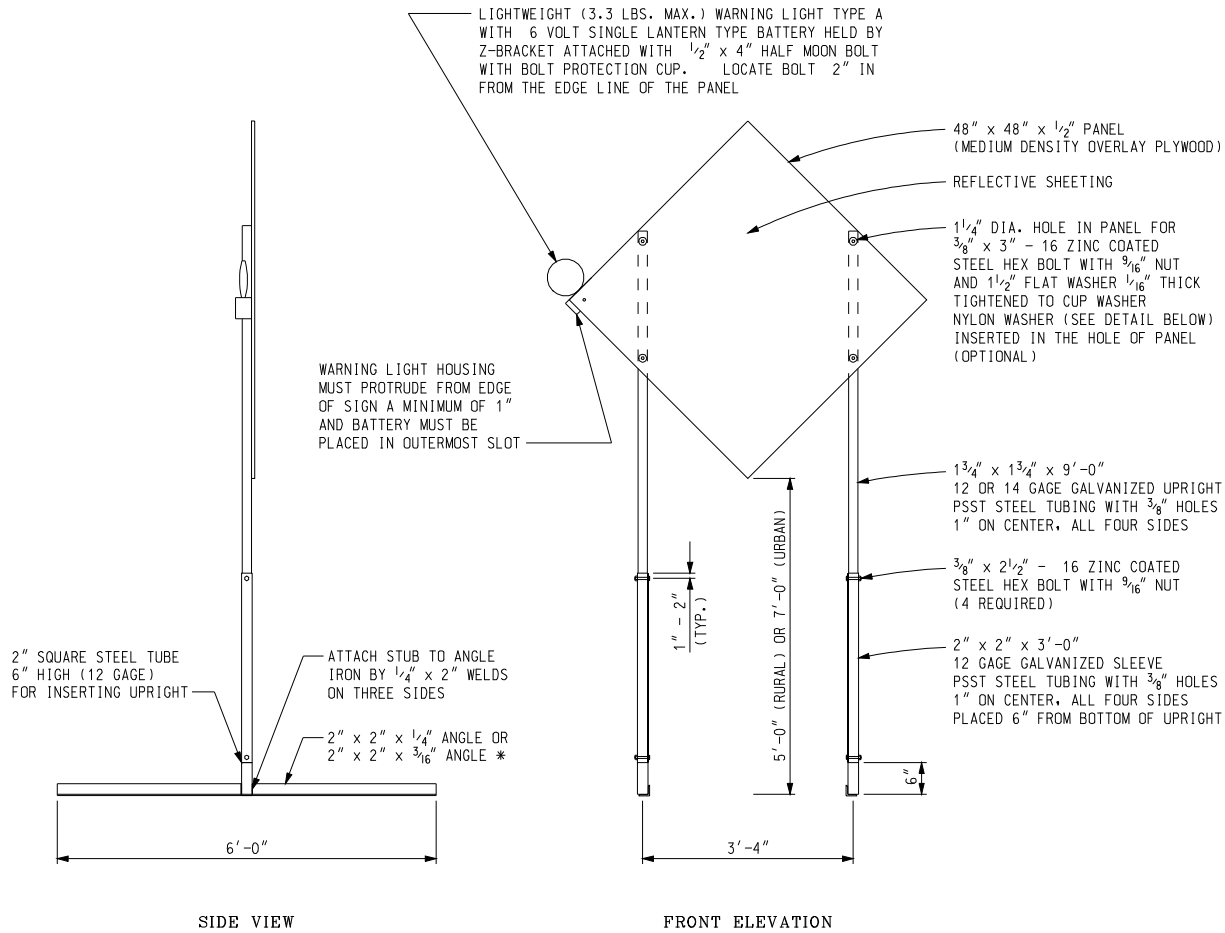

TEMPORARY SIGN SUPPORT

(WARNING LIGHT PLACED ON SIDE CLOSEST TO TRAFFIC)

- * SIGN STAND IS BALLASTED WITH FOUR OR MORE 35 LB SANDBAGS. A MINIMUM OF ONE ON EACH END.
- UPRIGHTS SHALL NOT EXTEND ABOVE THE SIGN PANEL.

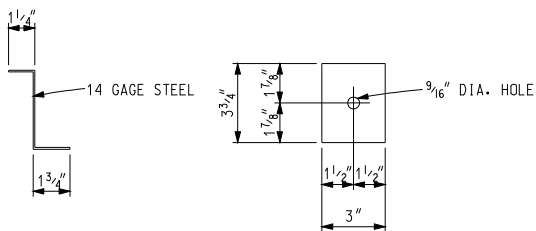

Z-BRACKET DETAIL

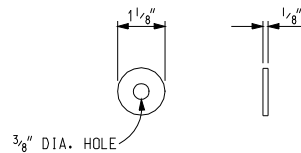

OPTIONAL NYLON WASHER

Other temporary sign supports meeting current NCHRP crash worthy criteria can be found on the FHWA Safety website at http://safety.fhwa.dot.gov/roadway_dept/road_hardware/wzd.htm

NOT TO SCALE

MICHIGAN DEPARTMENT OF TRANSPORTATION
BUREAU OF HIGHWAYS DELIVERY STANDARD PLAN

(SPECIAL DETAIL)
FHWA APPROVAL DATE

9/22/09
PLAN DATE

WZD-125-E

SHEET
2 of 3

NOTE: THE ORIGINAL SIGNED COPY IS KEPT ON FILE AT THE MICHIGAN DEPARTMENT OF TRANSPORTATION.

- PLASTIC DRUM
- ▲▲▲ PROPOSED TYPE III BARRICADE
- △△△ EXISTING TYPE III BARRICADE

SYMBOLS TO BE USED ON PLANS

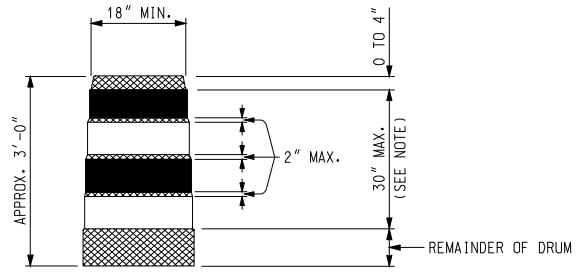

- REFLECTORIZED ORANGE
- REFLECTORIZED WHITE
- NON REFLECTORIZED ORANGE

NOTE:
 DRUMS SHALL HAVE AT LEAST 4 HORIZONTAL REFLECTORIZED STRIPES (2 ORANGE AND 2 WHITE) OF 6" UNIFORM WIDTH, ALTERNATING IN COLOR WITH THE TOPMOST REFLECTORIZED STRIPE BEING ORANGE. NON REFLECTORIZED SPACES BETWEEN THE HORIZONTAL REFLECTORIZED ORANGE AND WHITE STRIPES SHALL BE ORANGE IN COLOR AND EQUAL IN WIDTH.

PLASTIC DRUM

NOTES:

2" PERFORATED SQUARE STEEL TUBES MAY BE USED TO FABRICATE THE HORIZONTAL BASE OF THE TYPE III BARRICADE.

WARNING LIGHTS SHALL BE PLACED ACCORDING TO THE CURRENT STANDARD SPECIFICATIONS FOR CONSTRUCTION AND ALL OTHER PROVISIONS IN THE CONTRACT WHEN THEY ARE USED ON TYPE III BARRICADES.

SEE ROAD STANDARD PLANS R-113-SERIES FOR TEMPORARY CROSSOVERS FOR DIVIDED ROADWAY, AND R-126-SERIES FOR TYPICAL LOCATION AND SPACING OF PLASTIC DRUMS FOR PLACEMENT OF TEMPORARY CONCRETE BARRIER.

SIGNS, BARRICADES, AND PLASTIC DRUMS SHALL BE FACED WITH PRESSURE-SENSITIVE REFLECTIVE SHEETING ACCORDING TO THE CURRENT STANDARD SPECIFICATIONS FOR CONSTRUCTION.

SANDBAGS SHALL BE USED WHEN SUPPLEMENTAL WEIGHTS ARE REQUIRED TO ACHIEVE STABILITY OF THE BARRICADE. THE SANDBAGS SHALL BE PLACED SO THEY WILL NOT COVER OR OBSTRUCT ANY REFLECTIVE PORTION OF THE TRAFFIC CONTROL DEVICE.

NOT TO SCALE

MICHIGAN DEPARTMENT OF TRANSPORTATION BUREAU OF HIGHWAYS DELIVERY STANDARD PLAN	(SPECIAL DETAIL) FHWA APPROVAL DATE	9/22/09	WZD-125-E	SHEET 3 of 3
File: T&S/Typ/Signs/WorkZones/wzd 125 d	Rev. 09/22/09 PJ	PLAN DATE		

NOTE: THE ORIGINAL SIGNED COPY IS KEPT ON FILE AT THE MICHIGAN DEPARTMENT OF TRANSPORTATION.

MICHIGAN
DEPARTMENT OF TRANSPORTATION

SPECIAL PROVISION
FOR
INSURANCE

CSD:JDM

1 of 1

APPR:KF:DBP:09-17-14

Add the following after the first paragraph in subsection 107.10.C.4, on page 60 of the Standard Specifications for Construction:

In addition to the above insurance requirements, the following agencies must be listed as additional insured:

Midland County
Midland County Road Commission

MIDLAND COUNTY ROAD COMMISSION

SPECIAL PROVISION
FOR
COFFERDAMS

OHM:CDS

1 of 1

03/16

a. Description. Cofferdams shall be designed, furnished, installed, and maintained as specified in Section 704 of the Michigan Department of Transportation (MDOT) 2012 Standard Specifications for Construction, as shown in the plans, as shown in the approved shop drawings, as directed by the Engineer, and as specified herein.

b. Materials. The materials for Cofferdams shall meet the applicable requirements specified in the MDOT 2012 Standard Specifications for Construction and shall be approved by the Engineer prior to the Contractor starting work.

c. Construction. The method for constructing Cofferdams may consist of sheet piling, diversion piping, well points, sand bags, or an alternate method as shown in the shop drawings and as approved by the Engineer. The Contractor shall submit shop drawings to the Engineer showing the planned materials, construction, and soil erosion control methods. The shop drawings will be reviewed and returned in 15 working days. The shop drawings must be approved by the Engineer prior to the Contractor starting work. Cofferdams must be at a minimum, above the 100 year storm elevation.

d. Measurement and Payment. The completed work as measured for Cofferdams will be paid for at the contract unit price for the following:

Contract Item (Pay Item)	Pay Unit
Cofferdams.....	Lump Sum

Cofferdams will be paid for as one lump sum for the life of the contract and this shall be considered as payment in full for all labor, equipment, and materials shown on the plans, as shown in the approved shop drawings, as specified in this provision, and as directed by the Engineer to accomplish this work. Removal of the cofferdam is also included in the pay item Cofferdams, Modified.

MICHIGAN
DEPARTMENT OF TRANSPORTATION

SPECIAL PROVISION
FOR
GEOSYNTHETIC REINFORCED SOIL WALL

CFS:CDJ

1 of 7

APPR:TES:RWS:05-19-17

a. Description. The work consists of providing all labor, equipment, and materials necessary to furnish and install a geosynthetic reinforced soil wall in accordance with the contract, the standard specifications, and as directed by the Engineer.

The following definitions apply when used herein and on the plans:

Geotextile Reinforcement. Biaxial geotextile reinforcement having strength and stiffness that are approximately equal in both the machine and the cross machine directions.

Geosynthetic Reinforced Soil (GRS). Alternating layers of compacted granular fill reinforced with geotextile reinforcement. Facing elements are connected to the reinforcement layers to form an outer GRS Wall. Facing elements must consist of either splitface or solid concrete masonry units (CMU).

Reinforced Soil Foundation (RSF). A reinforced soil mass located below the GRS. This mass consists of alternating layers of compacted aggregate and geotextile reinforcement.

Retained Soil. Backfill located behind the GRS wall mass.

b. Materials. The basis of acceptance for all materials not addressed by the standard specifications or specified herein will be a test data certification in accordance with the *Materials Quality Assurance Procedures Manual*. Provide all test data certifications to the Engineer prior to material use.

1. Concrete Masonry Units:

a. Splitface/Solid Concrete Masonry Block. - Shall meet ASTM C90 with following exceptions:

- i. Minimum Compressive Strength = 4000 psi
- ii. Maximum Absorption Rate = 6.5%
- iii. See plan notes for more information.

2. Geotextile Reinforcement. Within the GRS and RSF, use a woven, high density polyethylene, polypropylene or high-tenacity polyester, biaxial geotextile that is resistant to ultraviolet (UV) oxidation and degradation caused by chemical and temperature exposures encountered in the highway environment. The weatherometer test data certification can be for the product line material type in general and does not have to be tested directly from the lot of geotextile produced for this site.

Identify the ASTM type, class, group, grade, and category of the primary resin used in manufacturing within the test data certification as applicable.

Provide a test data certification showing that the lot of geotextile reinforcement proposed for this site meets the physical property requirements of Table 1.

Table 1: Woven Geotextile Reinforcement Properties

Property	Test Method	Minimum Value (Unless Otherwise Noted)
Ultimate Tensile Strength MD(a) CMD(a)	ASTM D 4595 Strain Rate of 10% per minute	4,800 lb/ft 4,800 lb/ft
Tensile Strength @ 2% Strain MD(a) CMD(a)	ASTM D 4595	950 lb/ft 950 lb/ft
Apparent Opening Size	ASTM D 4751	0.60 mm Maximum
Inherent Viscosity (PET (b) only)	ASTM D 4603	Minimum Number Average Molecular Weight of 25000
Carboxyl End Group (PET (b) only)	ASTM D 7409	Maximum of Carboxyl End Group Content of 30
UV Resistance	ASTM D 4355	>70% breaking strength after 500 hr
a. "MD" and "CMD" represent 'machine' and 'cross-machine' directions, referring to the principle directions of the manufacturing process. b. PET - Polyester		

The Engineer will obtain samples from on-site material. One sample will be obtained from the first 1,500 square yards with subsequent samples obtained every 5,000 square yards. Samples must be a minimum of 8 feet long by the full roll width, with a 6 square yard minimum. Samples must be rolled, not folded, and shipped in a manner to prevent creases in the fabric. Acceptance testing will be used for ultimate tensile strength, tensile strength at 2 percent strain and apparent opening size. The test data certification will be used for acceptance of inherent viscosity, carboxyl end group and UV resistance.

3. GRS Granular Fill. Use either AASHTO #89 aggregate or 34G open-graded aggregate as granular fill material within the GRS wall mass as noted on the plans. The compacted material must have a minimum angle of internal friction of 38 degrees per AASHTO T 236 (large scale direct shear test) or AASHTO T 296 (large scale triaxial compression test, unconsolidated undrained). Provide a test data certification from an independent testing laboratory for the angle of internal friction for the proposed aggregate source. The testing for angle of internal friction must include at least 3 tests on different samples of the proposed source material.

4. Retained Soil. If additional embankment fill is required behind the GRS wall mass, provide Structure Backfill, CIP as detailed on the plans. Backfill, Structure, CIP will be paid for separately.

5. Reinforced Soil Foundation. Provide 21AA or 6A aggregate within the wrapped geotextile reinforcement layers for the RSF volume as noted on the plans. If 6A aggregate is used, it must consist of at least 80 percent crushed material.

6. Miscellaneous Concrete. May be needed for placement inside the hollow core of the segmental block unit or for use as a footing/leveling pad as directed by the Engineer. Use Portland cement concrete meeting the requirements for Grade S1 concrete according to section 701 of the Standard Specifications for Construction, except as modified herein. Use coarse aggregate originating only from geologically natural sources meeting physical requirements of Class 26A.

c. Submittals. Provide an electronic pdf of all submittals to the Engineer at least 21 days prior to the start of RSF or GRS wall construction. The Engineer will approve or reject the submittals within 14 calendar days after receipt of a complete submission. Additional time required due to incomplete or unacceptable submittals will not be justification for time extension or impact or delay claims. All costs associated with incomplete or unacceptable submittals will be borne by the Contractor.

1. Submit test data certifications for the following:

- A. Proposed aggregates.
- B. Geotextile reinforcement.
- C. Proposed CMU.

2. Submit CMU working drawings that include all details, dimensions, quantities, and cross sections necessary to construct the wall. Include how the RSF and GRS zones tie into the CMU used, as well as wall elevation views. Drawings should include but not be limited to the following items:

A. Plan and elevation sheets for each wall.

(1) On wall elevation views, show elevations at the top of the wall for all horizontal and vertical break points and at least every 25 feet along the face of the wall. Show elevations at all steps in the RSF.

(2) On wall plan views, indicate the offsets from the construction centerline to the wall reference line at all changes in horizontal alignment, beginning and ending stations for the wall and the location and size of any obstructions/appurtenances that are behind, in front of, under, mounted upon, or passing through the wall as shown on the plans.

(3) On typical cross sections, show the relationship between existing ground elevations and proposed grades, construction limits, excavation limits and fill requirements. Include obstructions/appurtenances that are behind, in front of, under, mounted upon, or passing through the wall as shown on the plans.

(4) Show general construction and material notes.

(5) Show horizontal and vertical curve data for laying out and constructing the walls.

B. Detail sheets for each wall.

- (1) Show parapet barriers, curbs, and sidewalks to be placed on top of the wall.
- (2) Show construction around obstructions/appurtenances that are behind, in front of, under, mounted upon, or passing through the wall as shown on the plans. Show details for diverting reinforcement elements around obstructions for each specific occurrence.
- (3) Include details for foundation underdrains shown on the plans.
- (4) Show details of end treatment at the wall point of beginning (POB) and wall point of ending (POE).

d. Construction.

1. Subgrade Preparation. Excavate to the elevations and dimensions shown on the plans. Provide surface water run-off controls to prevent excessive flow into the excavation. Provide groundwater control for the excavation. Prior to wall construction, inspect the RSF subgrade and compact, if necessary, in accordance with subsection 205.03.1.1 of the Standard Specifications for Construction, or prepare as required in the contract. Undercut unsuitable material as directed by the Engineer. Undercutting of unsuitable material will be paid for separately as Excavation, Fdn. Unless otherwise directed by the Engineer, replace undercut soils with Backfill, Structure, CIP compacted to 95 percent of the maximum density according to section 205 of the Standard Specifications for Construction. Structure Backfill, CIP will be paid for separately.

If the base of the excavation is left open, grade the base to one end to facilitate the removal of any water intrusion with a pump. If the excavation is flooded, remove all water along with any unsuitable soils, as directed by the Engineer. Final subgrade must be smooth, uniform and free from irregular surface shape or protruding objects that would obstruct placement of geotextile wrapped reinforced aggregate fills for the RSF.

2. Reinforced Soil Foundation. For 21AA, construct the RSF in accordance with the plans. Place backfill in lifts measuring not more than 8 inches in thickness. Compact backfill within this zone to 98 percent of its maximum density as determined by the One Point Michigan Cone Test of the *Density Testing and Inspection Manual*. Decrease the maximum lift thickness if necessary to obtain the specified density. For 6A, compact as described in subsection d.3.D of this special provision.

Encapsulate the entire RSF with geotextile reinforcement. The wrapped corners of the RSF must be tight and without exposed soil. Minimum shingle overlaps of 2 feet are required regardless of structure location. For GRS walls adjacent to waterways, overlap the RSF geotextile reinforcement a minimum of 3 feet. For proper shingle flow of water over the overlaps, start with the outer layer of the overlap situated on the upstream side of the RSF. Orient overlapped sections of geotextile reinforcement to prevent water from penetrating the layers of reinforcement.

Pull the Geotextile Reinforcement taut to remove all wrinkles prior to placing and compacting the backfill. Place fill starting at the river side front face and proceeding towards the back to push out folds or wrinkles towards the free end of the reinforcement layer. Locate the end of the overlap at least 3 feet from the RSF edge.

If the Engineer determines that a sheet pile type cofferdam or use of temp sheeting is necessary to adequately complete construction of the RSF, these items will be paid for separately and in accordance with the standard specifications. The Contractor should expect that shallow earth berm type cofferdams will be necessary for RSF construction. The costs associated with establishing earth berm type groundwater control and use of submersible pumps and other dewatering equipment for RSF construction will be included in the items covering the general foundation excavation of the GRS wall volume and in the item Reinforced Soil Foundation Aggregate.

3. Geosynthetic Reinforced Soil Wall. Place courses of CMU, and GRS systematically per the contract and the approved installation procedures.

A. Concrete Masonry Unit Placement. Place each course of CMU level, even, and within plan tolerance. Place adjacent blocks against each other to prevent backfill from escaping between gaps. Offset subsequent courses of block by half a block width so that vertical joints are not continuous.

Check the vertical alignment of the GRS wall face at least every other block layer. Correct any deviations greater than 0.25 inches. Check every other row of block alignment with a string line referenced off the back of the facing block from wall corner to corner. Correct deficiencies as required.

At right-angle wall corners, stagger face wall and wing wall block courses to form a tight, interlocking, stable corner. For walls with angles larger than 90 degrees, form a vertical seam or joint and install rebar and concrete as indicated on the plans.

B. GRS Granular Fill. Follow the placement of each course of block closely with granular fill. Place granular fill so as to avoid any damage or disturbance of the wall materials or any misalignment of the block units or soil reinforcement. Remove and replace any wall CMU and geotextile reinforcement that become damaged or misaligned during granular fill placement at no cost to the Department. Any depressions present behind the CMU must be filled level to the top of the CMU prior to placing the geotextile reinforcement.

For #89 or 34G, compact as described in subsection d.3.D of this special provision to achieve a minimum angle of internal friction of 38 degrees.

Since the CMU are not rigidly connected to the geotextile reinforcement, perform compaction within 3 feet of the back face of the CMU utilizing lightweight, hand operated compaction equipment (e.g., a lightweight mechanical tamper, plate, or roller). Adjust granular fill lift heights in order to achieve the compaction requirements. Check the position of the CMU after compaction. Remove and reset any elements that have been displaced to their proper location and position.

Ensure uniform moisture content throughout each layer of the granular fill prior to and during compaction. Place the granular fill at a moisture content that is no greater than the optimum.

At the end of each day's operation, slope the last layer of the granular fill away from the wall face and cover with a suitable water-resistant tarp, to rapidly direct runoff away from the wall face. Do not allow surface runoff from adjacent areas to enter the wall

construction site.

C. Geotextile Reinforcement. Place geotextile reinforcement in continuous full-length strips from the wall face to the design strip lengths without use of overlap or factory seam splices in the critical load bearing dimensions. Place the strong direction (typically the machine direction) of the geosynthetic perpendicular to the GRS wall face, unless otherwise directed by the Engineer. Extend the geotextile reinforcement so that it is situated between layers of CMU to provide a frictional connection. The geotextile reinforcement must extend to within 1 inch of the wall face unless dimensioned otherwise on the plans. Remove all excess geotextile reinforcement extending beyond the wall face by cutting with a razor knife or other means approved by the Engineer.

Uniformly tension geotextile reinforcements to remove any slack in the connections or materials, so that geotextile reinforcements are taut, free of wrinkles, and flat. Where overlaps exist on top of the CMU, trim as necessary to prevent varying geotextile reinforcement thickness or excessive gaps between adjacent blocks.

Place granular fill starting at the wall face and moving backwards to remove and prevent the formation of wrinkles in the geotextile reinforcement. Correct any misalignment or distortion of the wall face in excess of the tolerances specified herein at no additional cost to the Department.

Driving equipment directly on the geotextile reinforcement is prohibited. Place a minimum 6 inch layer of granular fill prior to operating any vehicles or equipment over the geotextile reinforcement. Tracked vehicles are prohibited above the geotextile reinforcement.

D. Density Tests. For each layer of granular fill placed behind an GRS wall, the Engineer must perform at least three field density tests. Do not penetrate the geotextile reinforcement with field density equipment. If the granular fill is such that it cannot be tested accurately with a nuclear gauge, then the Engineer will develop a test method passed on a number of passes of the compaction equipment and the visual movement of the aggregate. This test method will address compaction and testing near the wall surface (within 3 feet) for smaller hand operated equipment and further away from the wall for larger ride-on rollers.

e. **Measurement and Payment.** The completed work, as described, will be measured and paid for at the contract unit price using the following pay items:

Pay Item	Pay Unit
High Strength Woven Polypropylene Fabric	Square Yard
Granular Embankment, AASHTO #89 Stone	Cubic Yard
RSF, MDOT 21AA, CIP, Crushed Limestone	Cubic Yard
Solid Concrete Masonry Block.....	Each
Splitface Concrete Masonry Block	Each
Reinforcement, Steel, Epoxy Coated Dowel	Linear Feet
Concrete Cap	Linear Feet

1. **High Strength Woven Polypropylene Fabric** includes overlaps when determining the final as placed quantity. **High Strength Woven Polypropylene Fabric** includes miscellaneous hardware.

2. **Granular Embankment, AASHTO #89 Stone** includes miscellaneous hardware, and there will not be any adjustments in price for use of 34G.

3. **RSF, MDOT 21AA, CIP Crushed Limestone** includes all materials, and labor to construct geotextile fabric encasement, aggregates, miscellaneous hardware. Payment for **RSF, MDOT 21AA, CIP Crushed Limestone** also includes any dewatering materials, equipment and labor necessary to place the RSF for the GRS walls.

4. **_ Concrete Masonry Block** includes miscellaneous hardware. Payment for **Block Units** also includes incorporation of aesthetic details (block style and color) required in the contract.

5. **Reinforcement, Steel, Epoxy Coated Dowel** includes all materials to install the #4 rebar in the top four layers of **_ Concrete Masonry Block**, including the concrete used to fill the hollow cores in those layers.

6. **Concrete Cap** includes materials and installation of precast caps to match the concrete masonry units to finish the tops of the wingwalls and abutments outside of the superstructure.

Underdrains, if required on the plans or by the Engineer, will be paid for separately in accordance with the standard specifications.

Excavation, Fdn and Structure Backfill, CIP required for undercutting unsuitable subgrade soils below the plan RSF elevation will be paid for separately in accordance with the standard specifications. The bottom of the RSF reinforced soil mass shown on the plans will be considered the bottom of footing for measurement purposes.

MIDLAND COUNTY ROAD COMMISSION

SPECIAL PROVISION
FOR
HOT MIX ASPHALT APPLICATION ESTIMATE

OHM:CDS

1 of 1

03/16

a. Description. This work shall consist of furnishing and placing HMA, LVSP in accordance with Section 502 of the Michigan Department of Transportation (MDOT) 2012 Standard Specifications for Construction, as specified in the proposal, as directed by the Engineer, and as specified herein.

b. Materials. Materials shall be furnished by the Contractor and shall meet the requirements as specified in Section 501 and Section 904 of the MDOT 2012 Standard Specifications for Construction, as specified in the proposal, and as directed by the Engineer.

HMA, 4E3 (Leveling Course) shall have a yield of 220 pounds per square yard. The Asphalt Binder shall meet the Michigan Department of Transportation Performance Graded Asphalt Binder Specifications for 58-28.

HMA, 5E3 (Top Course) shall have a yield of 220 pounds per square yard. The Aggregate Wear Index (AWI) shall be a minimum of 220. The Asphalt Binder shall meet the Michigan Department of Transportation Performance Graded Asphalt Binder Specifications for 58-28.

The **Bond Coat SS-1h** material shall be as specified per the Michigan Department of Transportation (MDOT) 2012 Standard Specifications for Construction. The application rate used on existing hot mix asphalt pavement, or between courses, shall be 0.00 to 0.10 gallons per square yard.

c. Measurement and Payment. The completed work as measured for HMA 4E3 and 5E3 will be paid for respectively at the contract unit price per ton.

HMA 4E3; and HMA 5E3 will be measured in place by the unit ton and will be paid for at the contract unit price per ton, which price shall be payment in full for all labor, equipment, and materials shown on the plans, as specified in this provision, and as directed by the Engineer to accomplish this work. All labor, equipment, and materials required to place the Bond Coat will not be paid for separately, but will be considered as having been included in the contract unit price bid for other hot mix asphalt (HMA) pay items.

MIDLAND COUNTY ROAD COMMISSION

SPECIAL PROVISION
FOR
MACHINE GRADING, MODIFIED

OHM:CDS

1 of 1

03/16

a. Description. Machine Grading, Modified shall be constructed as shown in the plans and as specified in Section 205 of the Michigan Department of Transportation (MDOT) 2012 Standard Specifications for Construction with the following exceptions and additions.

b. Construction. Machine Grading, Modified shall include grading, regardless of depth, to develop the cross section shown on the plans. Operations may include scarifying, plowing, disking, moving, compacting, and shaping the earth. Loading or hauling of material will be necessary and shall be included in this item. This item shall also include stripping and stockpiling of topsoil, and the removal of all existing signs and posts. Ditches shall be graded to drain runoff waters. All intersections, approaches, entrances, and driveways shall be graded as shown or as directed. The Engineer must approve using the excavation from ditches and roadbed in shaping shoulder and adjacent fills.

c. Measurement and Payment. The completed work as measured for Machine Grading, Modified will be paid for at the contract unit price for the following:

Contract Item (Pay Item)	Pay Unit
Machine Grading, Modified	Station

Machine Grading, Modified will be measured in place by length in stations along the centerline of the project proper (includes both sides) excluding the length of the proposed bridge, which price shall be payment in full for all labor, equipment, and materials shown on the plans, as specified in this provision, and as directed by the Engineer to accomplish this work. Restoration items will be paid for separately.

MICHIGAN
DEPARTMENT OF TRANSPORTATION

SPECIAL PROVISION
FOR
PRECAST CONCRETE PLANKS, MODIFIED

DES:OHM

1 of 8

APPR:CER:

a. Description. This work consists of the manufacture of structural precast concrete footings and the storage, transportation and erection of these elements including grouting in place. Work must be performed in accordance with the standard specifications and as modified herein.

b. Materials.

1. Concrete. Provide concrete in accordance with the requirements listed in section 701 of the Standard Specifications. The concrete must meet the requirements of Concrete Grade D.

2. Reinforcement Bars. Provide reinforcement in accordance with the requirements listed in section 905 of the standard specifications.

3. Lifting Devices. Items cast into the elements to facilitate construction must be galvanized or epoxy coated.

c. Fabrication Requirements.

1. Plant Certification. Use plants certified according to one of the following:

- Precast/Prestressed Concrete Institute (PCI) for Precast Bridge Products, Category B1 or;
- National Precast Concrete Association (NPCA).

2. Shop Plans. Submit shop plans according to subsection 708.03.A.2 of the Standard Specifications for Construction and the requirements herein:

A. The shop plans must detail the lifting and erection details including details for lifting hardware and adjustment procedures. The Contractor is responsible for the arrangement of all lifting and handling devices, in addition to any supplemental epoxy coated reinforcement for handling, transportation, erection, and operation. Calculations for supplemental reinforcement for handling, transportation, erection, and operation must be submitted to the Engineer for approval. The calculations must be stamped by a Professional Engineer licensed in the State of Michigan. Use embedded inserts and erection devices with a pullout strength at least equal to four times the actual weight lifted. Use the following static load multipliers to account for stripping, transportation, handling, and erection:

- (1) Stripping and transportation. 1.5

(2) Yard handling and erection. 1.7

B. At least 30 working days prior to erection, the Contractor must submit a geometry control plan that indicates the proposed means and methods of element erection. The geometry control plan must indicate the measures that will be implemented to achieve the finished elevations.

3. Forms. Use metal forms; however, wood forms may be used for bulkheads if desired. In addition to the requirements of subsection 706.03.D of the Standard Specifications for Construction, the forms used to cast the elements must be capable of:

A. Producing the elements within the tolerances specified in subsection c.12 of this special provision.

B. Accommodating blockouts, openings and protrusions.

C. Stripping without damage to the concrete.

Where sections of forms are joined, on the exterior face of the element, an offset in excess of 1/16 inch for flat surfaces and 1/8 inch for corners and bends will not be permitted. Metal forms surface treatment must be in accordance with subsection 706.03.D.3.f. of the Standard Specifications for Construction. End headers must be maintained to provide a smooth casting surface.

4. Fabrication. Reinforcing steel must be fabricated and placed according to the plans and the standard specifications. Any conflict or interference with the proper location of reinforcing must be promptly resolved and corrections made as directed by the Engineer.

A positive means of holding the mechanical splice sleeves or inserts in their correct position must be provided in all cases and must be indicated on the shop plans.

All precast elements must be marked where they will be exposed after erection with a unique identification, approved by the Engineer, at the time of form removal. This identification must be used to identify each unit in the shop plans and calculations and any other document pertaining to the fabrication and erection of precast elements.

Provide access for the Department for quality assurance inspection. Provide the Engineer with a 2 week notification prior to start of fabrication. The inspection is not considered a substitute for the manufacturer's quality control requirements as stated herein.

5. Placing Concrete. Concrete must not be deposited into forms until the entire set up of the forms, reinforcements, mechanical splice sleeves, and other embedded items has been thoroughly inspected and checked.

During conveying, placement, and initial set, the concrete must be protected against undue drying or rise in temperature and inclement weather. The placing of concrete will also not be permitted until the Engineer is satisfied that adequate measures, and protection, are available to prevent weather damage during conveying and placement.

Plan the sequence of placing concrete to assure that voids do not occur within the concrete in areas where air is likely to be entrapped within the forms or in areas where flow of the plastic concrete is constrained by embedded items.

Hauling and placing equipment must be of a size and design that will permit the placing of concrete within the time limits set in subsection 706.03.H of the Standard Specifications for Construction. Concrete must be placed in horizontal layers not more than 1.5 feet thick except as hereinafter provided. When less than a complete layer is placed in one operation, it must be terminated in a vertical bulkhead.

Belt conveyors must be horizontal or at a slope which will not cause excessive segregation or loss of ingredients. An approved device must be used at the discharge end of a belt conveyor to prevent aggregate segregation. Mortar must not be allowed to adhere to the return length of the belt. Concrete must be discharged into a hopper or through a baffle.

No construction joints will be permitted within an element except as detailed on the plans.

6. Vibration. All concrete must be consolidated by means of high frequency internal vibrators in accordance with subsection 706.03.H.1 of the Standard Specifications for Construction.

The use of external vibrators for consolidating concrete will be permitted and may be required when the concrete is inaccessible for adequate consolidation. When external vibration is used, the forms must be constructed sufficiently rigid to resist displacement or damage. Vibrating of concrete must be done in such a manner as to avoid displacement of reinforcing, mechanical splice sleeves, and other embedded items.

7. Removal of Forms. Weight supporting forms must remain in-place until the concrete has reached the compressive strength specified in subsection 706.03.O of the Standard Specifications for Construction for form removal.

Ensure spalling and chipping of the concrete does not occur when removing the forms.

8. Test Samples. Concrete testing must be in accordance with subsection 708.03.A.7 of the Standard Specifications for Construction with the exception that compressive strength testing for shipping and 28-day strength requirements will consist of the average of two test cylinders.

9. Curing Concrete. Curing must be in accordance with subsection 708.03.A.11 of the Standard Specifications for Construction with the exception that the maximum curing temperature and concrete temperature is 150 degrees Fahrenheit.

10. Finishing Concrete. All surfaces of the elements must be finished as described in subsection 706.03.R.1 of the Standard Specifications for Construction.

11. Surface Preparation at Cast-in-Place Joints. The element surfaces in contact with non-shrink grout must be prepared as specified below.

After the segment concrete has hardened, the cement paste must be removed to create a prepared surface. The surface must be prepared by washing with water under pressure and by sandblasting to expose clean, well bonded aggregate.

To facilitate the removal of the cement paste, the element form in this area may be thoroughly covered with a surface retarder. When the surface retarder is applied directly to the fresh concrete surface, its application must be completed within 30 minutes after concrete placement.

The surface retarder must be a ready-to-use liquid compound that delays the set of a concrete surface, and must be approved by the Engineer in advance of beginning of the work. It must produce results satisfactory to the Engineer and will be evaluated by tests performed by the Engineer, and on the manufacturer's data recommendations.

The prepared surface of the element must be wetted a minimum of 3 hours before application of the new concrete. The surface must be maintained in a dampened condition during that period. One hour before placing the new concrete, any excess water must be removed and the surface must be allowed to dry. At the time of placement, the surface must be saturated surface dry (SSD) with no visible moisture or darkening of the bond surface.

At the option of the Contractor, immediately before placing the new concrete, the prepared surface must be covered with a thin coat of mortar. The mortar must be composed of 1 part portland cement and 1 part sand, and sufficient water to produce a thick fluid. All joint surfaces must receive a thorough, even coating applied by hand scrubbing. No concrete can be placed over dry mortar. Mortar that is allowed to become dry must be removed and replaced at the Contractor's expense.

12. Fabrication Tolerances. Fabrication tolerances must not exceed the following:

Length = $\pm 1/4$ inch
Width = $\pm 1/4$ inch
Depth = + $1/4$, - $1/8$ inch
Cover = + $1/4$, - 0 inch

d. Review and Repair of Damaged or Defective Elements.

1. Defects.

A. Terminology.

Isolated Defects. Are defects or damage that occurs randomly and infrequently, as determined by the Engineer.

Recurring Defects. Are defects or damages of the same general type and nature, which continue to be found in the same general location of the elements at an unacceptable frequency, as determined by the Engineer.

B. All elements cast will be jointly inspected by the Engineer, the Contractor, and the Contractor's Engineer after casting, after moving to storage from the casting machine, and before and after erection. All element defects will be identified and categorized during this inspection. The Contractor and the Contractor's Engineer must examine the defects and propose to the Engineer, in writing:

(1) The measures that the Contractor will take to prevent recurring defects in future elements; and,

(2) The method of repair of all defects discovered as a result of the inspection as required herein.

C. If recurring defects continue following implementation of the Contractor's preventive measures, or as detected at any time during the construction, the Engineer will instruct the Contractor, in writing, to cease operations producing such defective elements. The Contractor and the Contractor's Engineer must examine the defects and propose to the Engineer, in writing:

(1) The measures the Contractor will take to prevent recurring defects in future elements; and,

(2) The method of repair of all defects discovered as a result of the inspection as required herein.

D. The Engineer will determine what constitutes damage or defect, whether the damage or defect is isolated or recurring, and will categorize the damage or defects. Three categories of defects are recognized by the Engineer for this purpose:

(1) Cosmetic. Cosmetic defects or damages are those which do not affect the ability of the element to resist construction or service loads or reduces the life expectancy of the structure. This category of defect includes superficial discontinuities such as cracks, small spalls or honeycombed areas, or any defect that does not extend beyond the centerline of any reinforcing steel.

Cosmetic defects of other types and causes may also be designated by the Engineer. Repair of cosmetic defects must be made in such a manner that the aesthetics and the integrity of the element is restored.

(2) Structural. This category of defect includes any defect that will impair the ability of the element to adequately resist construction or service loads or reduce the life expectancy of the structure. Any defect or damage that extends beyond the centerline of any reinforcing steel is considered a structural defect.

Examples of such defects include cracks, large spalls and honeycombed areas, major segregation or breakage of concrete; however, structural defects of other types and causes may be designated by the Engineer.

The Contractor's Engineer is responsible for construction load analysis, service load analysis, and life expectancy determinations.

Repair of structural defects must be such that the structural integrity of the element is completely restored to a condition to be expected had the defect or damage not occurred.

(3) Rejectable. A rejectable defect is any defect or damage, as determined by the Engineer, which will impair the ability of the element to adequately resist service loads or construction loads, or will reduce the life expectancy of the structure and

which cannot be successfully repaired such that the structural integrity is completely restored. Any element with a rejectable defect will be deemed unacceptable and must be removed from the work and replaced at no additional cost.

Damaged or defective elements may also be rejected by the Engineer for the following reasons:

- (a) Failure of the Contractor's Engineer to approve proposed repair procedures.
- (b) Failure of the Contractor to execute the repair according to the Contractor's Engineer's approved procedure.
- (c) Rejection of the proposed repair procedure or repair by the Engineer.
- (d) Failure of the Contractor to provide the required certification or demonstration that the repair was successful and that the defect no longer exists, as required below.
- (e) Failure of the Contractor to eliminate recurring defects.
- (f) Determination by the Engineer that the work or materials used in the work does not meet other requirements of the contract and is not acceptable.

Elements with cosmetic defects will be paid for according to the contract price. However, such payment is subject to review by the Engineer, and failure of the Contractor to prosecute the required repairs properly and in a timely manner will be cause for withholding of payments sufficient to protect the Department.

Elements with structural defects will not be paid for until the repair procedure is complete and the element is certified or demonstrated to be free of structural defect as required.

2. Repairs. Cosmetic repairs must only be made following procedures prepared by the Contractor, submitted in writing to and approved by the Engineer.

Structural repairs must be made following procedures prepared by the Contractor. The repair procedure must be signed and sealed by the Contractor's Engineer, must be submitted in writing to the Engineer, and must include the following minimum information:

- A. A detailed description and sketch of the defect.
- B. The magnitude and type of the most critical construction loading and service life condition to which the defective area will be subjected.
- C. Detailed reinforcement requirements, material types, surface treatments, curing methods and general repair procedures proposed. The procedure must clearly indicate the areas that are required to be repaired before erection, and those areas to be repaired after erection.
- D. The specific nondestructive testing method and procedure by which the Contractor will demonstrate to the Engineer that the defect no longer exists and the

element has been restored to a condition to be expected had the defect or damage not occurred.

In lieu of physical demonstration, on a case-by-case basis, the Engineer may allow the Contractor to substitute a written certification by the Contractor's Engineer that the repair has been performed satisfactorily and that the defect no longer exists.

This work can not be the basis for any request for extension of time or additional compensation.

e. Handling and Erection of Elements. The Contractor is responsible for proper handling, lifting, storing, transporting and erection of all elements so that they may be placed without damage.

Elements must be stored, lifted and/or moved in a manner to prevent torsion and other undue stress. When moving a segment, lift it by the loop devices detailed on the plans, unless an alternate lifting device and procedures are approved by the Engineer. Apply equal loads to all lifting devices. Elements may be moved for storage or placement after the curing has been completed and after a flexural strength of 425 psi (or 3000 psi compression) has been achieved. The Contractor may alter the mix design and move the elements earlier provided a flexural strength of 425 psi (or 3000 psi compression) has been achieved and provided that the curing time is interrupted by no more than 2 hours. Lifting locations are indicated on the plans. Elements must be supported in a manner that will minimize warping. The Contractor must not erect the segments until the concrete gained the 28-day strength requirement.

Inspect each element visually for evidence of damage or defect before, during and after critical operations and as often as necessary to ensure adequate quality control. The Contractor must immediately bring all such evidence of damage or defect to the attention of the Engineer. The extent and frequency of inspection by the Engineer for quality assurance is the Engineer's prerogative. Elements may be inspected at any time during construction as deemed necessary by the Engineer to monitor compliance with this special provision. Prior to shipment and upon arrival at the erection site, each element must be inspected for damage. During transport, the elements must be fully secured against shifting. Upon arrival at the erection site, each element must again be inspected.

If any damage has occurred during shipment, the Contractor must immediately notify the Engineer. Erection of such damaged elements into the structure can not proceed without authorization from the Engineer.

Develop the method of construction in a manner that is also consistent with the overall substructure design. The Contractor is solely responsible for design, fabrication, assembly and operation of all equipment to be used for handling and erecting elements.

No extra payment will be made to the Contractor for any cost incurred in modifying the permanent structure due to temporary loading induced by the Contractor's handling and erection equipment or his erection scheme.

The elements must be erected on non-metallic shim stacks or using other support devices approved by the Engineer to achieve the proper installed element geometry and grout pad thickness.

f. **Measurement and Payment.** The completed work, as described, will be measured and paid for at the contract unit price using the following pay item:

Pay Item	Pay Unit
Precast Concrete Planks, Modified.....	LSUM

Precast Concrete Planks, Modified includes full compensation for furnishing and erecting the structural precast concrete elements including all the equipment, tools, joint fillers, grouting material of the footing beds, labor cost (including all grouting operations) and incidental items required to complete the work.

Reinforcing steel and all other embedded components of the precast concrete elements are included in pay item **Precast Concrete Planks, Modified**.

No additional payment will be made for extra concrete and reinforcing steel necessitated by approved modifications to the elements, joints, or structure for the purposes of the Contractor's construction methods.

No additional payment will be made for cosmetic or structural repairs necessitated by casting operations, transportation, handling, or erection of the segments

MIDLAND COUNTY ROAD COMMISSION

SPECIAL PROVISION
FOR
RIPRAP, HEAVY, MODIFIED
RIPRAP, PLAIN, MODIFIED

OHM:CDS

1 of 1

03/16

a. Description. Riprap, Heavy, Modified and Riprap, Plain, Modified shall be constructed as shown in the plans and as specified in Section 813 of the Michigan Department of Transportation (MDOT) 2012 Standard Specifications for Construction with the following exceptions and additions.

b. Materials. The materials for Riprap, Heavy, Modified and Riprap, Plain, Modified shall meet the requirements specified in Section 916 of the MDOT 2012 Standard Specifications for Construction and only shall be mined from a 100% limestone quarry.

c. Construction. Prior to placing Riprap, Heavy, Modified the Contractor shall shape the stream bottom and banks to a smooth contour that is parallel to the proposed reference lines. Prior to placing Riprap, Plain, Modified the Contractor shall shape the channel bottom and banks to a smooth contour.

d. Measurement and Payment. The completed work as measured for Riprap, Heavy, Modified and Riprap, Plain, Modified will be paid for at the contract unit price for the following:

Contract Item (Pay Item)	Pay Unit
Riprap, Heavy, Modified	Square Yard
Riprap, Plain, Modified	Square Yard

Riprap, Heavy, Modified and Riprap, Plain, Modified will be measured in place by the unit square yard and will be paid for at the contract unit price per square yard, which price shall be payment in full for all labor, equipment, and materials shown on the plans, as specified in this provision, and as directed by the Engineer to accomplish this work.

MIDLAND COUNTY ROAD COMMISSION

SPECIAL PROVISION
FOR
SALVAGEABLE ITEMS

OHM:CDS

1 of 1

02/15

a. Description. This work consists of salvaging and stockpiling removal items as directed by the Engineer.

b. Materials. Salvageable items shall include, but are not limited to signs, sign posts, guardrail, guardrail posts, and reflectors. The contractor shall remove items as determined to be salvageable by the Midland County Road Commission field staff with care and place materials at a designated on site location. The Midland County Road Commission will be responsible for loading and transporting the materials off site. The contractor will be responsible for providing access to the materials and handling them with care.

c. Measurement and Payment. This work will not be paid for separately. Payment will be included in associated removal items.

MIDLAND COUNTY ROAD COMMISSION

SPECIAL PROVISION
FOR
SLOPE RESTORATION, MODIFIED

OHM:CDS

1 of 2

03/16

a. Description. Slope Restoration, Modified shall be constructed as shown in the plans and as specified in Section 816 of the Michigan Department of Transportation (MDOT) 2012 Standard Specifications for Construction.

b. Materials. All materials shall meet the requirements as specified in Section 816.02 of the Michigan Department of Transportation (MDOT) 2012 Standard Specifications for Construction.

c. Construction. The Contactor shall restore all areas as described in Subsection 816.02 of the MDOT 2012 Standard Specifications for Construction. Materials shall be placed at rates described therein, or as directed by the Engineer.

In addition to using net anchors, mulch blankets adjacent to the road shall be trenched in to the ground at the top of slopes as approved by the Engineer.

Topsoil thickness shall be a minimum of 3 inches. In the event that sufficient suitable topsoil as approved by the Engineer is not available from the machine grading operations, the Contractor shall furnish the additional material as part of the Slope Restoration, Modified bid item. All other items will meet or exceed the rate called for in Section 816 of the MDOT Standard Specification for Construction.

Measurements for determining yield rates are hereby waived for this project. Performance requirements are not waived and the Contractor is to provide a well-established turf.

c. Measurement and Payment. Slope Restoration, Modified will be measured and paid for by Square Yard. Grading, Topsoil Surface, 3", Seeding, Mix TGM (Roadside) and Mix CR (Cereal Rye), Fertilizer, Chemical Nutrient Cl. A, Mulch Blanket, High Velocity, and Watering shall be used and will be considered as included in the pay item Slope Restoration, Modified. No separate payment will be made for the items of work.

The completed work for Slope Restoration, Modified will be measured for each structure and paid for at the contract Square Yard price for the following contract pay item, which shall be payment in full for all labor, equipment, and materials required.

Contract Item (Pay Item)	Pay Unit
Slope Restoration, Modified	Square Yard

Applications for payment for the work Slope Restoration, Modified will be made by the Engineer as follows. Upon completion of the work, 50% of the contract item quantity will be paid. After the grass germinates and the Engineer is satisfied that the grass germination will provide a well-established turf, the remaining balance of 50% of the contract item will be paid.

MICHIGAN
DEPARTMENT OF TRANSPORTATION

SPECIAL PROVISION
FOR
PROGRESS SCHEDULE

CFS:JJG

1 of 1

APPR:MB:LFS:07-07-17
FHWA:APPR:07-10-17

Delete the definition for Progress Schedule in subsection 101.03, on page 12 of the Standard Specifications for Construction, in its entirety and replace with the following:

Progress Schedule. A sequential listing of all the controlling operations and the estimated time the operations will remain controlling. The progress schedule is submitted by the Contractor after award and prior to starting work and is reviewed and approved by the Department. When approved, the progress schedule, or updated progress schedule, will become part of the contract.

Delete subsection 102.14, on page 22 of the Standard Specifications for Construction, in its entirety.

Delete the first sentence in the second paragraph of subsection 108.05, on page 74 of the Standard Specifications for Construction, in its entirety and replace with the following.

The Department may require a critical path method (CPM) schedule that will, upon approval, replace the progress schedule.

Add the following paragraphs directly below the first paragraph of subsection 108.05.A.1, on page 74 of the Standard Specifications for Construction.

The progress schedule is to be submitted by the Contractor to the Engineer within 7 calendar days of award and prior to starting work.

The Engineer will provide documented approval, comments, or rejection within 7 calendar days of receipt of the Contractor's submittal, resubmittal, or responses.

The Contractor must resolve all responses within 7 calendar days of receipt of any Engineer requests or rejections.

If the progress schedule is not approved within 30 calendar days of contract award, the Engineer may withhold all or part of contract payments until the progress schedule is approved.

Delete the last sentence in the first paragraph of subsection 108.05.A.2, on page 74 of the Standard Specifications for Construction in its entirety.

MICHIGAN
DEPARTMENT OF TRANSPORTATION

SPECIAL PROVISION
FOR
CONTRACTOR PERFORMANCE EVALUATIONS

CFS:MB

1 of 2

APPR:JGG:DBP:06-07-17
FHWA:APPR:06-07-17

a. Description. Project management staff will evaluate the Contractor's performance on this project and the evaluation may be used as a basis for modifying the prequalification ratings of the Contractor. An evaluation may be issued during the course of a project (interim) and will be issued after completion of a project (final). The criteria used for the evaluation will be provided by the Engineer upon written request at the preconstruction meeting or found on the MDOT web site. Any action to modify the Contractor's prequalification ratings will be taken in accordance with the duly promulgated prequalification rules.

If an interim contractor performance evaluation is issued and regardless of whether the Contractor requests a meeting to discuss a Contractor Performance Evaluation, project management staff may require the Contractor to submit a performance improvement plan to address needs identified in the Contractor Performance Evaluation and to attend a meeting to discuss the improvement plan. After the meeting is held, the project management staff may approve the plan or require changes to the plan. Resubmit the plan if changes are required. Performance improvement plans must be implemented per the time frame in the plan as approved by the Engineer. If the Contractor does not implement the plan as approved, MDOT will consider the Contractor to be in non-compliance and will take action as described under section c of this special provision.

Within 21 days of the receipt of a Contractor Performance Evaluation, the Contractor may make a written request to meet with project management staff to review the evaluation. As a result of this meeting, the evaluation may be left unchanged or revised as deemed appropriate by the Engineer. The Engineer will then give the Contractor written notice with the final Contractor Performance Evaluation. If the meeting is not requested within the 21-day period, the original evaluation becomes the final and will not be subject to later contest or appeal.

b. Appeals.

1. Appeal of Evaluation. Within 14 days after the date a performance evaluation becomes final and is received by a Contractor, they may file a written appeal of any rating of seven or below to the Engineer. The written appeal must contain documentation supporting the Contractor's position that the rating is not warranted. The appeal will be considered by a Contractor Performance Evaluation Appeal Panel. If no appeal is filed within the 14-day period, the evaluation becomes final and will not be subject to later contest or appeal. Interim Contractor Performance Evaluations cannot be appealed.

2. Appeal of Performance Improvement Plan. Within 14 days after the date that a performance improvement plan is approved and sent to the Contractor, the Contractor may file a written appeal of that plan to the Engineer and request to appear before a Performance Evaluation Appeal Panel. Documentation must include the reasons for the appeal. If a timely

written appeal is not filed, the performance improvement plan becomes final and will not be subject to later contest or appeal.

An appeal filed by a Contractor will be considered by a Contractor Performance Evaluation Appeal Panel. The panel will be composed of three licensed professional Engineers from the Department (following the format of a Central Office Review Panel) who were not directly involved in the management of the project. This panel will review appeals on all Contractor Performance Evaluations for this project. The Contractor and the Engineer will be required to submit supporting documentation relevant to the appeal and will attend a formal appeal hearing. Upon concluding its review, the panel will confirm or modify the Contractor Performance Evaluation. The panel will, within 30 days, send the Contractor and Engineer written notice of its decision along with a copy of the modified Contractor Performance Evaluation if applicable. The original or modified Contractor Performance Evaluation is final and constitutes the Department's decision; it is not subject to further contest or appeal.

c. Non-Compliance. If a Contractor fails to honor a request by project management staff to submit a performance improvement plan or to meet to discuss it, or if a Contractor fails to carry out an approved performance improvement plan, that failure may be used as a basis for modifying the prequalification ratings of the Contractor. Any action to modify the Contractor's prequalification ratings will be taken in accordance with the duly promulgated prequalification rules.

d. Subcontractors. For purposes of this special provision, the word "Contractor" includes subcontractors. Project management staff will evaluate the performance of subcontractors in accordance with this special provision.

MICHIGAN
DEPARTMENT OF TRANSPORTATION

SPECIAL PROVISION
FOR
LOW BID WITHDRAWAL PRIOR TO CONTRACT AWARD

CSD:JDM

1 of 1

APPR:JJG:DBP:07-02-13

FHWA:APPR:07-10-13

Add the following sentence to the end of the last paragraph in subsection 102.17, on page 24 of the Standard Specifications for Construction:

A determined low bidder whose bid is withdrawn prior to contract award cannot participate as a subcontractor, supplier, or trucker on the project.

Add the following sentence to the end of the fifth paragraph in subsection 108.01. on page 72 of the Standard Specifications for Construction:

The Contractor may not hire, a determined low bidder on a project who has withdrawn a bid prior to award, as a subcontractor, supplier, or trucker on the same project.

MICHIGAN
DEPARTMENT OF TRANSPORTATION

SPECIAL PROVISION
FOR
DISSEMINATION OF PUBLIC RELATIONS INFORMATION

CSD:JDM

1 of 1

APPR:JAT:DBP:07-01-14
FHWA:APPR:07-08-14

a. Description. This special provision establishes the requirements for dissemination of any public relations communications and/or products intended for an external audience pertaining to this contract. Dissemination must not be made without prior written approval from the Department, Office of Communications, and then only in accordance with explicit instructions by the Department. This includes the use of the Michigan Department of Transportation (MDOT) logo.

A violation of this provision may be considered a default of contract and the Department may exercise its rights in accordance with subsection 108.11 of the Standard Specifications for Construction.

b. Public Relations Information. Examples of communications and/or products may include, but are not limited to: brochures, flyers, invitations, programs, postings on social media sites or web sites, new or updated video, digital versatile disk (DVD) productions, or video sharing productions, exhibits, presentations, or any other printed materials intended for an external audience.

MICHIGAN
DEPARTMENT OF TRANSPORTATION

SPECIAL PROVISION
FOR
DEBRIS OR MATERIALS IN TRAFFIC LANES

CFS:BRZ

1 of 1

APPR:EMB:DAJ:01-10-08
FHWA:APPR:06-01-11

Delete Subsection 104.07.B.2 on page 36 of the Standard Specifications for Construction, in its entirety and replace it with the following:

- 2. Construction Safety Program.** Before beginning work on the project, the Contractor must submit a written "Construction Safety Program" that outlines the plan and procedures for preventing and mitigating accidents and fires on the project and meeting all health and safety requirements of the contract. Also in the program include provisions for meeting the requirements of subsection 812.03 and details for the materials and equipment that will be used to prevent construction related debris or materials from entering the open lanes of traffic and what actions, including traffic control measures, will be taken to immediately and safely remove the debris or material from the roadway. The Contractor must meet with the Engineer to discuss the "Construction Safety Program" and to develop mutual understandings to govern the administration and enforcement of the program.

Replace the second sentence in the first paragraph of Subsection 104.07.C.3 on page 37 of the Standard Specifications for Construction with the following:

The Contractor is responsible, at the Contractor's expense, to provide the necessary materials and equipment to prevent construction related debris or materials from entering the open lanes of traffic. This includes protection of traffic controls, removal of spilled materials or debris from the roadbed or drainage courses, and repair of damaged facilities necessary for public travel and safety.

MICHIGAN
DEPARTMENT OF TRANSPORTATION

SPECIAL PROVISION
FOR
HIGH VISIBILITY CLOTHING

SSA:JDG

1 of 1

APPR:MWB:CRB:06-18-14
FHWA:APPR:06-27-14

Add the following, to the end, of subsection 104.07.B, Safety and Health Requirements, on page 36 of the Standard Specification for Construction:

4. **Worker Visibility.** Effective November 24, 2008, all workers within the right-of-way who are exposed to traffic or to construction equipment within the work area, must wear high visibility clothing.

High visibility clothing or high visibility safety apparel is personal protective safety clothing that is intended to provide conspicuity during both daytime and nighttime usage. High Visibility safety apparel must meet the Performance Class 2 or 3 requirements of the American National Standards Institute/International Safety Equipment Association (ANSI/ISEA) 107-2004 for High-Visibility Safety Apparel and subsequent revisions thereof.

Costs incurred to comply with this requirement will be the responsibility of the Contractor.

MICHIGAN
DEPARTMENT OF TRANSPORTATION

SPECIAL PROVISION
FOR
VALUE ENGINEERING CHANGE PROPOSAL

CFS:EMB

1 of 4

APPR:SJP:DBP:03-17-10
FHWA:APPR:06-01-11

a. Description. A Value Engineering Change Proposal (VECP) modifying plans, specifications, or other contract requirements may be submitted for this project if the proposed change results in reduced construction cost, a higher quality product, improved safety, or a shorter contract time. The estimated cost savings must be quantifiable in relation to the contract cost. No work can begin before written authorization. The proposed change must not alter the essential functions or characteristics of the project or significantly delay the completion of the project. A VECP or conceptual VECP will only be considered after project award. Essential functions and characteristics include, but are not limited to, service life, operating costs, ease of maintenance, desired appearance, impact on utilities and right of way, mobility and safety of the motorist, bicyclist and pedestrian; design standards, and safety standards. This specification does not restrict the Contractor from proposing improvements to the project that may not result in net cost savings. A conceptual VECP stating the basic concept and approximate cost savings may be submitted for preliminary consideration.

b. Submittal of Conceptual VECP. Submit a Conceptual Proposal for the preliminary evaluation. Upon review by the Engineer, one of the following actions will be taken:

- Conceptual approval and a request for the Contractor to submit a formal VECP.
- Request for additional information.
- Denial of the VECP.

Preliminary review of a conceptual proposal reduces the Contractor risk of subsequent denial but does not commit the Department to eventual approval of the full VECP. Submit five copies of the following information for each Conceptual VECP using the Value Engineering Change Proposal Form (Form # 1962) marked Conceptual VECP.

1. A description of the difference between the existing contract items and the proposed changes, and expected benefits.
2. A set of conceptual plans and a description of proposed changes to the contract items.
3. An estimate of the anticipated cost savings or increase.
4. A date by which the Department must make a decision to avoid delays to the existing contract and obtain the cost savings. Also include information on the amount of time necessary to develop the full proposal and impacts to the progress schedule.
5. If impacting maintenance of traffic provisions, identify proposed changes and impacts to the Special Provision for Maintaining Traffic.

After approval of conceptual VECP, the Contractor must follow section c for the Final VECP.

c. Submittal of Final VECP. Submit five copies of the following information for each VECP using Value Engineering Change Proposal Form (Form # 1962) marked Final VECP.

1. A description of the difference between the existing contract and the proposed change, and the advantages and disadvantages of each, including effects on service life, operating costs, ease of maintenance, desired appearance, impact on utilities and right of way, mobility and safety of the motorist, bicyclist and pedestrian; design standards, and safety standards.

2. A complete set of plans, if necessary, and specifications showing the revisions relative to the original contract. This portion of the submittal must include design notes and construction details. If the proposal has plans, these must be signed and sealed by the Contractor's Professional Engineer licensed in the State of Michigan.

3. All costs and proposed unit prices must be documented by the Contractor and must include a cost comparison summarizing all the items the VECP replaces, reduces, eliminates, adds, or otherwise changes from the original contract on a spreadsheet.

4. A date by which the Department must make a decision to avoid delays to the existing contract and to obtain the proposed cost savings.

5. If impacting maintenance of traffic provisions, identify proposed changes and impacts to the Special Provision for Maintaining Traffic. If the submitted revisions to the maintaining traffic provision are approved and require any corrections, the Contractor is responsible for all additional costs related to corrective measures.

6. A statement detailing the affect the proposal will have on the time for completing the contract and impacts to the critical path and progress schedule.

7. A description of any known uses or testing of the proposed changes and the conditions and the results.

8. If the VECP submittal includes pay items associated with a warranty, include the latest version of the warranty specification.

d. Evaluation. By submitting the VECP, the Contractor agrees not to hold the Department liable for its decision or for any delays to the work attributable to the VECP. Decisions on VECP are not subject to appeal. Work on the project will continue in accordance with the requirements of the contract until a work order is issued which incorporates the VECP changes. The Department has final authority of the acceptability of a VECP and of the estimated net savings attributable to the adoption of all or any part of the VECP. If, in the judgment of the Engineer, contract prices do not represent a fair measure of the value of work to be performed or to be deleted, the Engineer will use other means to determine the estimated net savings.

The Department may modify a VECP, with the concurrence of the Contractor, in order to make it acceptable. The Contractor's share of the savings will be based on the modified VECP.

If the VECP is accepted, in whole or in part, the written acceptance will be issued by a work order and followed with a contract modification. The work order and contract modification will include the necessary changes in the plans and specifications and any conditions upon which the

approval is based. Acceptance of the VECP will not extend the time of contract completion unless specifically provided for in the work order and contract modification.

VECP will be evaluated in accordance with the following:

1. The Engineer will determine if a VECP qualifies for consideration and evaluation. The Engineer may deny any VECP that requires excessive time or costs for review, evaluation or investigation. The Engineer may deny any VECP that is not consistent with the Department's design policies and criteria for the project.

2. The Department will not accept a VECP that is similar to a change in the plans or specifications under consideration by the Department for the project at the time the proposal is submitted; nor will the Department accept a proposal based upon, or similar to, standard specifications, general use special provisions or standard drawings adopted by the Department after the advertisement for the contract. The Department reserves the right to make such changes without compensation to the Contractor under the provisions of subsection 103.02 of the Standard Specifications for Construction.

3. The Contractor will have no claim against the Department for additional costs or delays resulting from denial or untimely acceptance of a VECP. These costs include but are not limited to: development costs, loss of anticipated profits, increased material or labor costs, or untimely response.

4. A VECP will be denied if equivalent options are already provided in the contract.

5. A saving resulting solely from the elimination or reduction in quantity of a contract pay item will not be considered as a VECP. A saving resulting from the elimination or reduction in quantity of a contract item specified as part of a VECP may be considered.

6. In calculating the value of cost savings, the Department has the right to disregard the Contract bid prices, if such prices do not represent the value of the work to be performed or to be deleted, and has the right to calculate the savings based on reasonable cost for such work.

7. A VECP cannot be used to alter incentive and disincentive rates and maximum payments on A + B and/or lane rental projects.

8. A VECP will be denied if the design consultant for the contractor is also the design consultant for the Department or other apparent conflicts of interest exist.

e. Time Frame for VECP Evaluation. The Contractor will be notified of the Department's decision to approve or deny a conceptual or final VECP within 14 calendar days of receipt of the VECP. If a written acceptance has not been received within this time frame, and the date has not been extended by mutual agreement of both parties, the VECP is denied. The Department's decision is final and there is no appeal.

f. Future Use of VECP. The Department reserves the right to use all or any part of a VECP on other contracts without obligation or compensation to the Contractor. If the VECP is accepted, the Department may use or disclose any information necessary to incorporate the VECP on future projects.

g. Payment for Work under the VECP. The Engineer may reject all or any portion of work performed under an approved VECP if results are unsatisfactory. The Engineer will direct the removal of rejected work and construction will proceed under the original contract requirements. There will be no payment for work performed under the proposal, or for its removal.

No work related to a VECP will be performed under force account. Agreed prices must be reached for any new or modified contract pay items related to the VECP before the VECP is approved.

The changes will be incorporated into the Contract by changes in quantities of unit bid items, new agreed unit price items, lump sum or any combination, as appropriate, under the Contract. Unless there is a differing site condition as described in subsection 103.02 of the Standard Specifications for Construction, the Contractor will not receive additional compensation for quantity overruns, design errors, supplemental surveys, geotechnical investigations, additional items or other increases in cost that were not foreseen in the accepted VECP, unless otherwise approved by the Engineer.

The work order and authorization will include the price for performing all affected items of work and the estimated net savings in the cost of performing the work directly attributable to the VECP. VECP payments only involve direct savings or costs. Indirect savings or costs (time, user delay, contract delay, etc) are not included in VECP payment calculations. The calculations of VECP payments are independent from the payments or penalties for contract time related issues. The Contractor will be paid 50 percent of this net savings based on as constructed or plan quantities whichever is in the best interests of the Department. The amount specified in the work order and authorization constitutes full compensation to the Contractor for the VECP and the performance of that work.

$$(\text{Cost of Deleted Work}) - (\text{Cost of Added Work}) = \text{Net Savings}$$

$$\text{Payment} = (\text{Net Savings})/2$$

Note: Approved VECP's will be paid using the pay item code "1200000", item description of "Value Engineering" and the pay unit is "Dollar" for the contract modification.

The Contractor's development costs for the proposed VECP, including all costs associated with design, are not reimbursable.

MICHIGAN
DEPARTMENT OF TRANSPORTATION

SPECIAL PROVISION
FOR
SOURCE OF STEEL AND IRON (BUY AMERICA)

CFS:JYG

1 of 3

APPR:RJC:DBP:01-28-16
FHWA:APPR:01-31-16

Delete subsection 105.10, on page 53 of the 2012 Standard Specifications for Construction, in its entirety and replace with the following:

105.10. Source of Steel and Iron. Provide steel and iron materials and products for permanent incorporation into the work that were produced only in the United States per Title 23 of the Federal Code of Regulations (CFR) Section 635.410, Buy America Requirements.

All steel and iron products and manufacturing processes of the steel and iron material in a product, including but not limited to the following steps; smelting, melting, rolling, extruding, machining, bending, grinding, drilling, welding, galvanizing, and coating, must occur within the United States.

Examples of products that are subject to Buy America coverage include, but are not limited to, the following:

- A. Steel or iron products used in pavements, bridges, tunnels or other structures, which include, but are not limited to, the following: fabricated structural steel, reinforcing steel, piling, high strength bolts, anchor bolts, dowel bars, permanently incorporated sheet piling, bridge bearings, cable wire/strand, pre-stressing/post-tensioning wire, motor/machinery brakes and other equipment for moveable structures.
- B. Guardrail, guardrail posts, end sections, terminals, cable guardrail.
- C. Steel fencing material, fence posts.
- D. Steel or iron pipe, conduit, grates, manhole covers, risers.
- E. Mast arms, poles, standards, trusses, supporting structural members for signs, luminaires, or traffic control systems.
- F. Steel or iron components of precast concrete products, such as reinforcing steel, wire mesh and pre-stressing or post-tensioning strands or cables.

Provide step certification for all steel and iron related pay items, materials, products, and components as specified on the Department website. The Department will maintain a list of these pay items, materials, products, and/or components on the following website.

http://www.michigan.gov/mdot/0,1607,7-151-9622_11044_11367---,00.html

Step certification is defined as the certification by the respective manufacturer or fabricator for their specific process (step) that the product, material, or component was fabricated, manufactured, and/or processed in the United States. The step certification documentation for these pre-defined pay items, materials, products, and/or components is to be submitted to the Engineer in a package covering each step prior to delivery or concurrent with material delivery on-site. Approved certification is required prior to incorporation of the materials into the project.

Buy America certification documentation for products and materials designated as fully compliant with the Buy America requirements on the Qualified Products List (QPL), Approved Manufacturers, and Tested Stock Suppliers Lists will be maintained by the MDOT Construction Field Services (CFS) Division. Buy America certification for these fully compliant items does not need to be submitted by the Contractor, but a bill of lading, product label, or shipping record to document that the products are from the respective source is to be provided to the Engineer. Buy America certification documentation for items that are partially compliant will be required to be submitted prior to delivery or concurrent with material delivery and prior to incorporation, noting the value of foreign steel/iron. The use of the Department maintained Buy America lists and notations does not relieve the Contractor from responsibility of ensuring Buy America compliance. The Contractor is ultimately responsible for Buy America compliance.

The Buy America lists maintained by the Department are solely for the benefit of the Department and may not be relied upon by the Contractor. The Contractor is solely responsible for the Buy America requirements for steel and iron as set forth in the CFR.

The above requirements do not preclude a minimal use of foreign steel and iron, provided the total invoice cost of foreign material permanently incorporated into the project does not exceed 0.1 percent of the total contract amount or \$2,500 whichever is greater. The Department defines the total invoice cost as the total value of the foreign steel and iron materials delivered to the project. The Department defines the total contract amount to be the total of the contract unit prices for items of road work and bridge work, any adjustments as provided for in the contract, and any assessment of incentive, disincentive or liquidated damages as provided for in the contract.

MDOT/Consultant fabrication facility inspectors are not responsible for approving the incorporation of foreign steel/iron prior to fabrication. It is the responsibility of the fabricator to notify and coordinate with the Contractor for all potential inclusion of foreign steel/iron in fabricated products.

For each item subject to meeting Buy America requirements, that doesn't fully meet Buy America requirements, the following documentation must be provided by the Contractor to verify the foreign steel value. This documentation is to be placed in the project files to ensure that the threshold is not exceeded:

- Pay Item,
- Description of associated foreign steel/iron material, product, or component,
- Cost of associated foreign steel/iron material, product or component, and
- Cumulative list of all non-compliant Buy America items with the total dollar amount.

The minimal use of foreign steel/iron under the minimal usage amount will be approved by the Engineer. The use of foreign steel/iron under the minimal usage amount does not

need to be approved by the FHWA. This amount is not considered a waiver to the Buy America requirements. The Contractor must ensure that the minimal usage amount is not exceeded.

MICHIGAN
DEPARTMENT OF TRANSPORTATION

SPECIAL PROVISION
FOR
**NATIONAL POLLUTANT DISCHARGE ELIMINATION SYSTEM INSPECTION AND
RESPONSE**

CFS:DMG

1 of 1

APPR:TWK:HZ:07-02-14
FHWA:APPR:07-09-14

a. Description. There is the potential for disturbance of land totaling five acres or greater during construction of this project. Therefore, 1994 PA 451, Part 31 (Water Resources Protection) and Part 21 (Wastewater Discharge Permit Rules/National Pollutant Discharge Elimination System [NPDES]), apply to this project. The Department has filed a Notice of Coverage with the MDEQ. The MDEQ will return an authorization number to the Department.

The Engineer, in accordance with the NPDES regulations, will assign a Certified Storm Water Operator (SWO) to make project-wide reviews for NPDES compliance. Reviews will be made on projects with earth disturbances one acre or greater once every 7 days, and within 24 hours after every precipitation event that results in runoff from the site and ensure the completion of any needed corrective actions. A log of the inspections and corrective actions will be maintained on file for review and will be retained for a period of 3 years from the date of the inspection or corrective action.

The SWO will document the inspections and corrective actions onto the NPDES and Soil Erosion and Sedimentation Control Inspection Report (MDOT Form 1126). Deficiencies will be brought to the attention of the Contractor and this notice must include a deadline for completing the corrective actions.

The Contractor has a period of 5 calendar days in which to complete, or have completed, all corrective actions except those of an emergency nature required as a result of the NPDES inspection as indicated on Form 1126. Corrective actions of an emergency nature will be as determined by the Engineer and include sedimentation that occurs in streams, drainage structures, or watercourses, or erosion that affects the support of the roadbed or the safety of the public. Emergency corrective actions will be noted as such on Form 1126 and must be completed in an acceptable manner by the Contractor within 24 hours after notification.

MICHIGAN
DEPARTMENT OF TRANSPORTATION

SPECIAL PROVISION
FOR
CONSTRUCTION STAGING AREAS

DES:LFS

1 of 1

APPR:JJG:KAS:10-06-11
FHWA:APPR:10-11-11

Add the following subsection to section 107, on page 70 of the 2012 Standard Specifications for Construction:

107.22 Construction Staging Areas. The contractor must not use any public recreation area as a staging area, marshalling yard, storage facility, or for any other construction support unless it is defined in the contract.

Public recreation areas include: parks, trails, game areas, wildlife and waterfowl refuges, playgrounds, golf courses, athletic fields or similar areas which are publically owned by public school districts, local, state, or federal governments.

Any agreements negotiated between the Contractor and the owner of the public recreation area, before or after the award of the contract will not be considered valid by the Department.

If the Engineer determines the Contractor is in non-compliance with this subsection, penalties up to and including termination of the contract, in accordance with subsection 108.12, may be enacted as well as the immediate restoration of the public recreation area at the Contractor's cost.

MICHIGAN
DEPARTMENT OF TRANSPORTATION

SPECIAL PROVISION
FOR
E-VERIFY

CSD:JDM

1 of 1

APPR:JJG:JC:10-24-12
FHWA:APPR:10-25-12

a. Description. E-Verify is an Internet-based system that allows an employer, using information reported on an employee's Form I-9, Employment Eligibility Verification, to determine the eligibility of that employee to work in the United States. There is no charge to employers to use E-Verify. The E-Verify system is operated by the Department of Homeland Security (DHS) in partnership with the Social Security Administration. E-Verify is available in Spanish.

The State of Michigan is requiring all Contractors, and Subcontractors, to verify that new employees are legally present and authorized to work in the United States, using the E-Verify System.

Information on registration for and use of the E-Verify program can be obtained via the Internet at the DHS Web site: <http://www.dhs.gov/E-Verify>.

It is the responsibility of the Contractor to include this specification in all tiers of subcontracts.

Verification of the Contractors' use of E-verify will be a part of the random review of subcontract information performed by Contract Services Division.

The required use of the E-Verify system will not be paid for separately as part of the contract but is considered included in the costs for other pay items in the contract.

MICHIGAN
DEPARTMENT OF TRANSPORTATION

SPECIAL PROVISION
FOR
LABOR COMPLIANCE

CFS:AS

1 of 2

APPR:JJG:RJC:07-01-14
FHWA:APPR:07-09-14

a. Description. This special provision details the requirements for labor compliance. Ensure all levels of contracting (prime, sub, sub-sub, etc.) comply with all labor compliance requirements in this contract as well as with the current MDOT procedure for prevailing wage oversight. All contractors must insert this special provision in each subcontract and further require its inclusion in all lower tier subcontracts. The Contractor must advise all subcontractors of the requirement to pay the prevailing wage rates prior to commencement of work and that all employees must cooperate during wage rate interviews. The Contractor is responsible for all subcontractors and lower tier subcontractor labor compliance. Ensure labor compliance posters and the project specific prevailing wage rates are posted on the construction site, in a conspicuous place, prior to the commencement of work. Resolve all labor compliance issues within 60 days of receiving the Department's first documented notice. The 60 day requirement may be extended based on documented mutual agreement between the Department and the Contractor. A violation of state and/or federal prevailing wage rates or laws may result in the debarment of a Contractor from being awarded a contract or subcontract for a period of up to 8 years. Other actions, including but not limited to the reconciliation of records and restitution for employees, included in state and federal laws, may be required of the Contractor or subcontractor.

1. Record Keeping. Maintain payrolls and basic records relating thereto (i.e. W2, canceled checks, bank statements, payroll software etc.) by all levels of contractors during the course of work and preserved for a period of 3 years thereafter for all employees working on the site of work as outlined in 29 Code of Federal Regulations part 5.5 (29 CFR 5.5). Make these records available for inspection, copying, or transcription by the Department or its representative.

2. Certified Payroll Submittal Requirements. Subcontractors (all tiers) must submit their certified payrolls to the prime Contractor. The submitted payrolls must set out accurately and completely all of the information required on MDOT Form CP-347, Certified Payroll. The required weekly payroll information may be submitted on any contractor generated form, but must contain all information required on Form CP-347. Review all lower tier subcontractor certified payrolls prior to submission to the Engineer. The review must ensure the certified payroll complies with the submittal requirements as set forth in the current MDOT procedure for prevailing wage oversight. Complete Form 1955, Contractor's Certified Payroll Report, and submit to the Engineer along with the certified payrolls on a weekly basis. Forms 1955 and CP-347 are available on the MDOT forms webpage.

A. Federal Prevailing Wage Projects. The Davis-Bacon Related Acts apply to all contractors, and subcontractors (all tiers) performing work on federally funded or assisted construction contracts in excess of \$2,000. All contractors and subcontractors are required to comply with 29 Code of Federal Regulations Parts 1, 3, and 5.

B. State Prevailing Wage Projects. 1965 PA 166 applies to all contractors, and subcontractors (all tiers) performing work on contracts which are sponsored or financed in whole by the State of Michigan. On contracts involving two or more job numbers where the type of funding is mixed, and where one source of funding is federal, the Department inserts only the wage rates issued by the U.S. Department of Labor in the proposal and the federal requirements apply.

3. Short Duration Projects. The following modifications apply to the prevailing wage oversight procedure if the project is less than 75 calendar days in duration.

A. Submittal Requirements. The first certified payroll is to be received by the Engineer within 2 weeks from the end of the work week in which the work is started by the Contractor and/or subcontractors. The 2 week period is to allow for the processing and review of the certified payrolls by the Contractor. The first pay estimate can be made prior to the submission of the first certified payroll. The 2 week grace period allows the first estimate to be paid assuming the Contractor and subcontractor submit certified payrolls in a timely manner. Ensure subsequent certified payroll submissions are made weekly. Payroll submissions failing to meet the above requirements will be considered delinquent.

B. Contractor Notices. When certified payrolls are determined to be deficient or delinquent as defined in the current MDOT procedures for prevailing wage oversight the Engineer is to provide the prime Contractor with documented notice.

All labor compliance issues are to be resolved within 30 days after receiving the Department's first documented notice. The notification timeframe will be modified from 30 calendar days per notification to 15 calendar days per notification for short duration projects.

b. Materials. None specified.

c. Construction. None specified.

d. Measurement and Payment. Payment for compliance with this special provision will not be made separately. Payment will be considered as part of all other contract pay items.

MICHIGAN
DEPARTMENT OF TRANSPORTATION

SPECIAL PROVISION
FOR
OPEN TO TRAFFIC

CFS:JJG

1 of 1

APPR:MB:DBP:07-07-17
FHWA:APPR:07-10-17

Delete subsection 107.21, on page 69 of the Standard Specifications for Construction, in its entirety and replace with the following:

107.21. Open to Traffic. The Contractor must not open the project or sections thereof to traffic until approved by the Engineer. Whenever the project or section thereof is in a condition suitable for traffic, the Engineer will determine if it is approved for traffic before project completion and the Contractor must open the project or section thereof to traffic as directed by the Engineer. To determine whether the project or section thereof is approved for traffic, the Engineer will verify that the surfacing material, shoulders, guardrails, signs, and other appurtenances are completed as required by the contract. The Engineer's approval of the project or section thereof for traffic does not constitute partial or final acceptance of the project or any part of it, or a waiver of any provision of the contract. The Contractor is not responsible for the costs of maintaining the section of the project opened for traffic.

If the Engineer approves the entire project or any section of it for traffic and the Contractor opens it to traffic before final acceptance and final payment, the Contractor must perform the remainder of the work in a manner that causes the least obstruction to traffic. The Contractor must make provisions for the safety of traffic as required by the contract. Legal weight restrictions, established by 1949 PA 300 as amended, local ordinances, or legal posting, apply to sections of the project opened to traffic.

Before the seasonal suspension, the Engineer will determine the work the Contractor must complete to bring the project to an acceptable condition for traffic and winter maintenance, including necessary traffic and erosion control measures. Until the Contractor completes this work, the Engineer will not designate the project as approved for traffic. On sections of the project opened to traffic, the Contractor must correct damage due to defective materials, to faulty workmanship, to operations of the Contractor, and to natural causes (except as provided in subsection 107.11 of the Standard Specifications for Construction), at no additional cost to the Department.

MICHIGAN
DEPARTMENT OF TRANSPORTATION

SPECIAL PROVISION
FOR
ON-THE-JOB TRAINING PROGRAM

OBD:TDB

1 of 1

APPR:DBP:GCT:06-19-15
FHWA:APPR:07-06-15

a. Description. The On-The-Job Training (OJT) program is the MDOT's program to meet the requirements of the Federal-Aid Highway Act of 1970 and 23 CFR (Code of Federal Regulations) Part 230, Subpart A. The objective is to develop skill improvement programs to provide opportunities for unskilled workers, particularly minorities, women, and disadvantaged persons, to acquire training in the skilled construction trades.

b. Trainee Assignment. MDOT's Office of Business Development will allocate training assignments to prequalified Contractors based on the past contract volume of federal-aid work performed with MDOT. MDOT will notify each Contractor who has met the volume of work threshold at the beginning of each calendar year and advise them of the number of trainees they are expected to support.

c. Program Requirements. Contractors found to have reached the level(s), as identified in the MDOT OJT program document, are required to fulfill all of the requirements of the OJT program at no additional cost to the Department.

The Contractors are required to pay the trainees in accordance with the following schedule unless apprentices or trainees in an approved union program are enrolled as trainees on this project. In that case, the appropriate rates approved through the union apprenticeship will apply.

- 60 percent of the appropriate minimum journeyman's rate specified in the contract for the first half of the training period
- 75 percent for the third quarter of the training period
- 90 percent for the last quarter of the training period
- Full fringe benefits will be paid during the entire training period

All applicable forms and the appropriate regulation pertaining to the OJT program are available through the MDOT's On-the-Job Training Program website at www.michigan.gov/ojt.

Contractors should notify the Engineer at the preconstruction meeting if they intend to utilize trainees on the project.

d. Non-Compliance. Failure to comply with the OJT program provisions or complete a training assignment may result in the Contractor being found in non-compliance. Failure to resolve the non-compliance may be used as a basis for modifying the prequalification ratings of the Contractor. Any action to modify the Contractor's prequalification ratings will be taken in accordance with the duly promulgated prequalification rules.

MICHIGAN
DEPARTMENT OF TRANSPORTATION

SPECIAL PROVISION
FOR
SCHEDULE OF LIQUIDATED DAMAGES FOR OVERSIGHT

CFS:BED

1 of 1

APPR:MB:JJG: 07-15-16

FHWA:APPR:07-29-16

Delete Table 108-1 in subsection 108.10.C.1, on page 83 of the Standard Specifications for Construction, in its entirety and replace with the following.

Table 108-1		
Schedule of Liquidated Damages for Oversight		
Original Contract Amount		Amount per Calendar Day, \$
From more than, \$	To and including, \$	
0	100,000	400
100,000	500,000	700
500,000	1,000,000	950
1,000,000	5,000,000	1,350
5,000,000	15,000,000	2,300
Over 15,000,000		3,900

MICHIGAN
DEPARTMENT OF TRANSPORTATION

SPECIAL PROVISION
FOR
PROMPT PAYMENT

CFS:JJG

1 of 4

APPR:JDM:DBP:06-29-15
FHWA:APPR:07-16-15

Add the following subsection to section 109, on page 106, of the Standard Specifications for Construction:

109.08 Prompt Payment.

A. Definitions.

Lower-tier subcontract. An agreement between a subcontractor of any tier and any individual or legal entity to perform a part of the subcontract work.

Lower-tier subcontractor. The individual or legal entity that performs part of the subcontract work through a lower-tier subcontract with a subcontractor.

Supplier. The individual or legal entity that agrees to provide materials or services to the prime Contractor, a subcontractor, or a lower-tier subcontractor for the performance of their contract work.

Sworn Statement. A written verification under oath reflecting all persons or entities, which have furnished labor, equipment, services or materials to a subcontractor or lower-tier subcontractor for performance of work on the project. The written verification includes union fringe benefit funds, original contract amount, current amount due, amounts paid to date and balance to finish the work for each person or entity.

Waiver of Lien. A written release and waiver of any claim or right to payment for payments actually received for labor, equipment, services or materials furnished for performance of work on the project.

The sworn statement and waiver of lien documents are used by the prime Contractor and its subcontractors for verifying payments made to lower-tier subcontractors/suppliers and are not to be submitted to the Engineer unless requested as an aid in determining an alleged prompt payment violation. These documents can be found at the following website under the Construction Field Services - Forms heading:

http://www.michigan.gov/mdot/0,1607,7-151-9622_11044_11367---,00.html

B. Progress Payments. For the first payment, or for a one time payment, the prime Contractor agrees to pay each subcontractor for the work associated with their subcontract no later than 10 calendar days from the date the prime Contractor receives payment from the Department.

For the second and subsequent payments, the prime Contractor agrees to pay each

subcontractor for the work associated with their subcontract no later than 10 calendar days from the date the prime Contractor receives payment from the Department.

The Contractor is required to provide payment information for previous payments made to all first tier subcontractors and all DBE companies (sub-subcontractors, suppliers, truckers, etc.) at any tier before the Engineer will release the third and subsequent estimates. For all subsequent progress pay estimates if 1) the Engineer payment does not include any first tier subcontractors or any DBE company payments at any tier, and 2) the previously submitted payment reporting information remains unchanged, then payment reporting in the system is not required. Reporting is required when the prime contractor makes payments to any first tier subcontractors and any DBE companies at any tier. The payment information is provided through submittal of the information via the 2124A reporting system (MERS). System information can be found at the following web link.

http://www.michigan.gov/documents/mdot/Prompt_Payment_2124A_Instructions_MERS_366314_7.pdf

The prime Contractor must bring any concerns about the satisfactory completion of subcontractor or lower-tier subcontractor work items, to the Engineer's attention as soon as the concern is discovered. If the work meets the requirements of satisfactory completion and the prime Contractor has been paid for that work, the Engineer must determine whether:

1. The prime Contractor has demonstrated a valid reason for withholding payment from the subcontractor or supplier, or
2. The subcontractor has demonstrated a valid reason for withholding payment from the lower-tier subcontractor or supplier.

If the Engineer determines the reason for withholding payment is valid, the Engineer will process a negative estimate to withdraw the amount involved in the complaint. If payment has not been made for the work related to the complaint, the Engineer will not include those items of work on an estimate until the issue has been resolved.

The prime Contractor remains responsible to make prompt payments on this project to their subcontractors and suppliers except as noted in subsection 109.08.D of this special provision, even if the prime Contractor is in violation of other contractual obligations and the Department is withholding payment from the prime Contractor for those violations.

The prime Contractor must include language in all subcontracts that the Department prohibits prime Contractors from holding retainage from subcontractors. All provisions of this prompt payment subsection apply to all subcontracts, lower-tier subcontracts, and supplier agreements and must be included in each subcontract for the contract, including all lower-tier subcontracts and agreements.

This prompt payment provision is a requirement of 49 CFR 26.29 and does not confer third-party beneficiary rights or other direct rights to a subcontractor against the Department. This provision applies to both DBE and non-DBE subcontractors/suppliers at all tiers.

C. Satisfactory Completion. Progress and partial payments for contract work are issued based on the satisfactory completion of work. Satisfactory completion, for purposes of this prompt payment provision, is defined as:

1. Upon preliminary review, the Engineer finds the work completed in accordance with the contract, plans, and specifications; and,
2. Required documentation, including material certifications, payrolls, submission of 2124A, etc., has been received and reviewed and found to be acceptable by the Engineer; and,
3. Required subcontractor sworn statements and waivers of lien have been provided to the prime Contractor. The prime Contractor must provide notice to the Engineer if sworn statements and waivers of lien have not been received for completed work.

The Engineer will determine if the work meets the standards of satisfactory completion.

D. Less than full payment release. The Engineer may give written approval to:

1. Delay or postpone payment from the time frames specified herein,
2. Process partial payment from the prime Contractor to a subcontractor or supplier,
3. Process partial payment from a subcontractor to a lower-tier subcontractor or supplier.

The unpaid portion will be held by the Department.

The parties may initiate whatever dispute resolution procedure is specified in their agreement or is available under Michigan law. If dispute resolution or litigation is selected, the actions by both parties must proceed in a timely manner. The result of the dispute resolution proceeding or litigation must be provided to the Engineer promptly upon the conclusion of the proceeding. The Engineer will release the disputed payment being held by the Department in accordance with the outcome of the proceedings.

E. Non-Payment Claims. The prime Contractor, subcontractor, lower-tier subcontractor or supplier must notify the alleged offending party in writing of any prompt payment violations within 30 calendar days of the date the payment was to be received. Copies of the notifications must be provided to the Engineer and the prime Contractor (only if the prime Contractor is not the offending party).

The alleged offending party must respond in writing to the claimant within 10 calendar days of receipt of the notification of failure to meet prompt payment provisions. Provide copies of the response to the Engineer, the prime Contractor (only if the prime Contractor is not the offending party), and the Engineer of Construction Field Services. The prime Contractor, subcontractor, or supplier must also provide the required sworn statements and waivers of lien from the affected subcontractor or supplier to the Engineer within 10 days of receipt of the notification. The Department will consider the failure of the alleged offending party to respond to the notification from the claimant as an admission of the prompt pay violation which may result in sanctions.

The Engineer will review the written notice and response and will verify in writing if there is a valid prompt pay violation.

Independent of all procedures and requirements in this special provision the non-payment claimant has the additional option of submitting a lien claim to the MDOT Contract Services Division. MDOT will notify the project surety of the non-payment issue. It is the responsibility of

the surety to ensure that all legitimately due payments are made. The submission of a lien claim will not nullify or affect any other requirements, obligations or procedures in this special provision.

F. Remedies. When the Engineer verifies a prompt payment violation, the prime Contractor within 5 days must propose one or a combination of any of the following actions items for review and approval by the Engineer:

1. Issue payment to the subcontractor.
2. Issue payments to a subcontractor in the form of joint checks to the subcontractor and the subcontractor's lower-tier subcontractors and/or suppliers.
3. Issue payment directly to the subcontractor's lower-tier subcontractors or suppliers.
4. Request a negative estimate to withdraw the amount confirmed in the prompt payment violation.

If the prime Contractor fails to submit a timely remedy request or obtain an approved course of action within the 5 day time period, the Engineer will direct a course of action or issue a negative estimate to withdraw the amount confirmed in the prompt payment violation.

If the prime Contractor fails to fulfill the approved or directed course of action the Engineer will impose sanctions until such time as the approved or directed course of action is completed.

Any payments to a subcontractor's lower-tier subcontractor or supplier will be issued in the amounts reflected upon the subcontractor's sworn statements or in amounts independently verified by the Engineer as being due the subcontractor's lower-tier subcontractors and suppliers for work completed. Payments to a lower-tier subcontractor or supplier will be considered payment to the subcontractor directly so that payment for the same work cannot be claimed.

Any other use of joint checks must follow current Department procedures.

G. Sanctions. Failure to comply with any of the prompt payment requirements by the prime Contractor, subcontractor, lower-tier subcontractor, or supplier may result in sanctions against the offending party. These sanctions may include, but are not limited to: withholding of estimates on projects where prompt payment violations are confirmed; reduction or removal of prequalification; and/or suspension of bidding privileges.

MICHIGAN
DEPARTMENT OF TRANSPORTATION

SPECIAL PROVISION
FOR
FORCE ACCOUNT BUSINESS TAXES

CFS:RJC

1 of 1

APPR:JJG:JDM:04-14-15
FHWA:APPR:04-17-15

Delete subsection 109.05.D.8, on page 101 of the 2012 Standard Specifications for Construction in its entirety.

MICHIGAN
DEPARTMENT OF TRANSPORTATION

SPECIAL PROVISION
FOR
**FORCE ACCOUNT MARK-UP FOR BOND PREMIUM, INSURANCE AND PAYROLL
TAXES**

CFS:JJG

1 of 1

APPR:LFS:MB:08-12-16

FHWA:APPR:08-18-16

Delete subsection 109.05.D.4, on page 97 of the Standard Specifications for Construction, in its entirety.

Delete the first paragraph of subsection 109.05.D.3, on page 96 of the Standard Specifications for Construction, in its entirety and replace with the following:

3. **Labor.** The Engineer will pay the Contractor an amount equal to the sum of the following labor costs, plus 55 percent of the sum (for road work) or 60 percent of the sum (for bridge work) to cover the costs of field and home office overhead, bond premium, insurance, payroll taxes and to provide for a reasonable profit.

MICHIGAN
DEPARTMENT OF TRANSPORTATION

SPECIAL PROVISION
FOR
DELAY COSTS

CFS:JJG

1 of 1

APPR:RJC:MB:02-22-17
FHWA:APPR:02-27-17

Delete subsections 109.05.E.1.a through 109.05.E.1.e, on page 102 of the Standard Specifications for Construction, in their entirety and replace with the following:

- a. Proof of cost of project staff salaries, wages, payroll taxes and insurance.
- b. Proof of escalated cost for labor, equipment, and material.
- c. Proof of material storage costs.

MICHIGAN
DEPARTMENT OF TRANSPORTATION

SPECIAL PROVISION
FOR
JOBSITE POSTER DEFICIENCIES AND INITIAL MOBILIZATION PAYMENT

CFS:JYG

1 of 1

APPR:AS:RJC:05-27-16
FHWA:APPR:06-07-16

Delete the subsection 150.03, on page 107 of the Standard Specifications for Construction, in its entirety and replace with the following:

150.03. Construction. All jobsite posters and employment notices required by State and Federal regulations and the contract documents are to be posted as instructed in the Special Provision for Labor Compliance.

If at any time during the project the Engineer documents that the required jobsite posters and employment notices are not posted appropriately, the Engineer will provide documented instructions to the Contractor that corrective action is required. Posting of jobsite posters and employment notices (posted display, foreman vehicle binder, etc.) for short term or mobile operations will be as approved by the Engineer. Upon receipt of the notification of corrective action, the Contractor has 24 hours to correct the deficiency. If the issue cannot be corrected within the 24 hour time period, the Contractor will develop a documented implementation schedule for the corrective action and submit the schedule to the Engineer for approval within 24 hours of receiving the original documented notification. If the schedule is not approved, or if the schedule is approved, but is not followed, the Engineer will adjust the contract according to this special provision. If the implementation schedule is not followed, the Engineer will document notification to the Contractor that they are in violation of this special provision.

The Engineer will give documented notification to the Contractor as identified above. Failure to make corrections within the timeframe required will result in the following actions by the Engineer:

- A. The Engineer may stop work on the project until the Contractor completes corrective action.
- B. The Engineer will process a contract price adjustment in the amount of \$1,000 per calendar day or portion thereof that the corrective action remains incomplete or the implementation schedule is not followed. The contract price adjustment will continue to be assessed until jobsite posters and employment notices are posted appropriately, the Engineer has been notified of the corrective action and the Engineer has verified the correction.

Add the following paragraph after the third paragraph of subsection 150.04, on page 108 of the Standard Specifications for Construction:

The first scheduled payment for **Mobilization, Max (dollar)** will not occur until the Engineer has verified and documented the posting of required labor compliance posters and the project specific prevailing wage rates.

Sample of Posters Required on the Project

Visit the following websites for further information:

U.S. Department of Labor at <http://www.dol.gov/>

Michigan Department of Civil Rights <http://www.michigan.gov/mdcr>

Michigan Department of Labor and Economic Growth <http://www.michigan.gov/cis/>



http://www.michigan.gov/images/new_poster_8818_7.jpg



http://www.michigan.gov/documents/CR_487-E-S_76956_7.pdf

NOTICE TO ALL EMPLOYEES



Working on Federal or Federally Financed Construction Projects

MINIMUM WAGES

You must be paid not less than the wage rate in the schedule posted with this Notice for the kind of work you perform.

OVERTIME

You must be paid not less than one and one-half times your basic rate of pay for all hours worked over 40 a week. There are some exceptions.

APPRENTICES

Apprentice rates apply only to apprentices properly registered under approved Federal or State apprenticeship programs.

PROPER PAY

If you do not receive proper pay, contact the Contracting Officer listed below:



or you may contact the nearest office of the Wage and Hour Division, U.S. Department of Labor. The Wage and Hour Division has offices in several hundred communities throughout the country. They are listed in the U.S. Government section of most telephone directories under:
U.S. Department of Labor
Employment Standards Administration

WHD Publication 1321
Revised January 1986
U.S. GOVERNMENT PRINTING OFFICE: 1985-004-880

U.S. Department of Labor
Employment Standards
Administration
Wage and Hour Division



<http://www.dol.gov/esa/regs/compliance/posters/pdf/fedprojc.pdf>

Use if Davis Bacon Wage Rates Apply.

(Applies to all Federal-aid highway construction contracts exceeding \$2,000 and to all related subcontracts, except for projects located on roadways classified as local roads or rural minor collectors.)

MICHIGAN
DEPARTMENT OF TRANSPORTATION

SPECIAL PROVISION
FOR
AGGREGATE BASE DENSITY, BRIDGE APPROACH

CFS:DMG

1 of 1

APPR:SAB:CER:05-18-15
FHWA:APPR:05-28-15

a. Description. This special provision modifies the density requirement as detailed in subsection 302.03 of the Standard Specifications for Construction for aggregate base under concrete. This modification applies to the area within the limits of the bridge approach from the abutment wall to the typical roadway cross section.

b. Materials. None specified.

c. Construction. Place the aggregate base within the limits of the bridge approach in accordance with subsection 302.03 of the Standard Specifications for Construction except as modified herein. The density requirement for the aggregate base in this area must be at least 98 percent of the maximum unit weight.

d. Measurement and Payment. The completed work, as described, will be considered included in other pay items and will not be paid for separately.

MICHIGAN
DEPARTMENT OF TRANSPORTATION

SPECIAL PROVISION
FOR
SAMPLING ASPHALT BINDER ON LOCAL AGENCY PROJECTS

CFS:MF

1 of 1

APPR:JAR:JTL:12-19-01
FHWA:CON. APPR:06-06-11

For informational purposes, original samples of asphalt binder will be taken by the Contractor and delivered to the Engineer prior to incorporation into the mixture. The frequency of sampling will be determined by the Engineer. The cost of obtaining and delivering the samples to the Engineer will be included in the hot mix asphalt (HMA) pay items.

The Contractor must certify in writing that the materials used in the HMA mixture are from the same source as the materials used in developing the HMA mixture design and the bond coat is from an approved supplier as stated in the *Material Quality Assurance Procedures Manual*.

MICHIGAN
DEPARTMENT OF TRANSPORTATION

SPECIAL PROVISION
FOR
ACCEPTANCE OF HOT MIX ASPHALT MIXTURE ON LOCAL AGENCY PROJECTS

CFS:KPK

1 of 7

APPR:CJB:JWB:07-05-16
FHWA:APPR:07-05-16

a. Description. This special provision provides sampling and testing requirements for local agency projects using the roller method and the nuclear density gauge testing. Provide the hot mix asphalt (HMA) mixture in accordance with the requirements of the standard specifications, except where modified herein.

b. Materials. Provide aggregates, mineral filler (if required), and asphalt binder to produce a mixture proportioned within the master gradation limits shown in the contract, and meeting the uniformity tolerance limits in Table 1.

Table 1: Uniformity Tolerance Limits for HMA Mixtures

Parameter		Top and Leveling Course		Base Course		
Number	Description	Range 1 (a)	Range 2	Range 1 (a)	Range 2	
1	% Binder Content	-0.30 to +0.40	±0.50	-0.30 to +0.40	±0.50	
2	% Passing	# 8 and Larger Sieves	±5.0	±8.0	±7.0	±9.0
		# 30 Sieve	±4.0	±6.0	±6.0	±9.0
		# 200 Sieve	±1.0	±2.0	±2.0	±3.0
3	Crushed Particle Content (b)	Below 10%	Below 15%	Below 10%	Below 15%	
<p>a. This range allows for normal mixture and testing variations. The mixture must be proportioned to test as closely as possible to the Job-Mix-Formula (JMF).</p> <p>b. Deviation from JMF.</p>						

Parameter number 2 as shown in Table 1 is aggregate gradation. Each sieve will be evaluated on one of the three gradation tolerance categories. If more than one sieve is exceeding Range 1 or Range 2 tolerances, only the one with the largest exceedance will be counted as the gradation parameter.

The master gradation should be maintained throughout production; however, price adjustments will be based on Table 1. Aggregates which are to be used in plant-mixed HMA mixtures must not contain topsoil, clay, or loam.

c. Construction. Submit a Mix Design and a JMF to the Engineer. Do not begin production and placement of the HMA until receipt of the Engineer's approval of the JMF. Maintain the binder content, aggregate gradation, and the crushed particle content of the HMA mixture within the Range 1 uniformity tolerance limits in Table 1. For mixtures meeting the definition of top or leveling course, field regress air void content to 3.5 percent with liquid asphalt cement unless

specified otherwise on HMA application estimate. For mixtures meeting the definition of base course, field regress air void content to 3.0 percent with liquid asphalt cement unless specified otherwise on HMA application estimate.

Ensure all persons performing Quality Control (QC) and Quality Assurance (QA) HMA field sampling are "Local Agency HMA Sampling Qualified" samplers. At the Pre-Production or Pre-Construction meeting, the Engineer will determine the method of sampling to be used. Ensure all sampling is done in accordance with *MTM 313 (Sampling HMA Paving Mixtures)* or *MTM 324 (Sampling HMA Paving Mixtures Behind the Paver)*. Samples are to be taken from separate hauling loads.

For production/mainline type paving, obtain a minimum of two samples, each being 20,000 grams, each day of production, for each mix type. The Engineer will sample and maintain possession of the sample. Sampling from the paver hopper is prohibited. Each sample will be divided into two 10,000 gram parts with one part being for initial testing and the other part being held for possible dispute resolution testing. Obtain a minimum of three samples for each mix type regardless of the number of days of production.

Obtain samples that are representative of the day's paving. Sample collection is to be spaced throughout the planned tonnage. One sample will be obtained in the first half of the tonnage and the second sample will be obtained in the second half of the tonnage. If planned paving is reduced or suspended, when paving resumes, the remaining sampling must be representative of the original intended sampling timing.

Ensure all persons performing testing are Bit Level One certified or Bit QA/QC Technician certified.

Ensure daily test samples are obtained, except, if the first test results show that the HMA mixture is in specification, the Engineer has the option of not testing additional samples from that day.

At the Pre-Production or Pre-Construction meeting, the Engineer and Contractor will collectively determine the test method for measuring asphalt content (AC) using *MTM 319 (Determination of Asphalt Content from Asphalt Paving Mixtures by the Ignition Method)* or *MTM 325 (Quantitative Extraction of Bitumen from HMA Paving Mixtures)*. Back calculation will not be allowed for determining asphalt content.

Ensure all labs performing local agency acceptance testing are qualified labs per the *HMA Production Manual* and participate in the MDOT round robin process, or they must be *AASHTO Materials Reference Laboratory (AMRL)* accredited for *AASHTO T 30* or *T 27*, and *AASHTO T 164* or *T 308*. Ensure on non-National Highway System (NHS) routes, Contractor labs are made available, and may be used, but they must be qualified labs as previously stated. Contractor labs may not be used on NHS routes. Material acceptance testing will be completed by the Engineer within 14 calendar days, except holidays and Sundays, for projects with less than 5,000 tons (plan quantity) of HMA and within 7 calendars days, except holidays and Sundays, for projects with 5,000 tons (plan quantity) or more of HMA, after the Engineer has obtained the samples. QA test results will be provided to the Contractor after the Engineer receives the QC test results. Failure on the part of the Engineer or the laboratory to provide Quality Assurance test results within the specified time frame does not relieve the Contractor of their responsibility to provide an asphalt mix within specifications.

The correlation procedure for ignition oven will be established as follows. Asphalt binder content based on ignition method from MTM 319. Gradation (*ASTM D 5444*) and Crushed particle content (*MTM 117*) based on aggregate from *MTM 319*. The incineration temperature will be established at the Pre-Production Meeting. The Contractor will provide a laboratory mixture sample to the acceptance laboratory to establish the correction factor for each mix. Ensure this sample is provided to the Engineer a minimum of 14 calendar days prior to production.

For production/mainline type paving, the mixture may be accepted by visual inspection up to a quantity of 500 tons per mixture type, per project (not per day). For non-production type paving defined as driveways, approaches, and patching, visual inspection may be allowed regardless of the tonnage.

The mixture will be considered out-of-specification, as determined by the acceptance tests, if for any one mixture, two consecutive tests per parameter, (for Parameter 2, two consecutive aggregate gradations on one sieve) are outside Range 1 or Range 2 tolerance limits. If a parameter is outside of Range 1 tolerance limits and the second consecutive test shows that the parameter is outside of Range 2, then it will be considered to be a Range 1 out-of-specification. Consecutive refers to the production order and not necessarily the testing order. Out-of-specification mixtures are subject to a price adjustment per the Measurement and Payment section of this special provision.

Contractor operations will be suspended when the mixture is determined to be out-of-specification, but contract time will continue to run. The Engineer may issue a Notice of Non-Compliance with Contract Requirements (Form 1165), if the Contractor has not suspended operations and taken corrective action. Submit a revised JMF or proposed alterations to the plant and/or materials to achieve the JMF to the Engineer. Effects on the Aggregate Wear Index (AWI) and mix design properties will be taken into consideration. Production and placement cannot resume until receipt of the Engineer's approval to proceed.

Pavement in-place density will be measured using one of two approved methods. The method used for measuring in-place density will be agreed upon at a pre-production or pre-construction meeting.

Pavement in-place density tests will be completed by the Engineer during paving operations and prior to traffic staging changes. Pavement in-place density acceptance testing will be completed by the Engineer prior to paving of subsequent lifts and being open to traffic.

Option 1 Direct Density Method

Use of a nuclear density gauge requires measuring the pavement density using the Gmm from the JMF for the density control target. The required in-place density of the HMA mixture must be 92.0 to 98.0 percent of the density control target. Nuclear density testing and frequency will be in accordance with the *MDOT Density Testing and Inspection Manual*.

Option 2 Roller Method

The Engineer may use the Roller Method with a nuclear or non-nuclear density gauge to document achieving optimal density as discussed below.

Use of the density gauge requires establishing a rolling pattern that will achieve the required in-place density. The Engineer will measure pavement density with a density gauge using the Gmm from the JMF for the density control target.

Use of the Roller Method requires developing and establishing density frequency curves, and meeting the requirements of Table 2. A density frequency curve is defined as the measurement and documentation of each pass of the finished roller until the in-place density results indicate a decrease in value. The previous recording will be deemed the optimal density. The Contractor is responsible for establishing and documenting an initial or QC rolling pattern that achieves the optimal in-place density. When the density frequency curve is used, the Engineer will run and document the density frequency curve for each half day of production to determine the number of passes to achieve the maximum density. Table 5, located at the end of this special provision, can be used as an aid in developing the density frequency curve. The Engineer will perform density tests using an approved nuclear or non-nuclear gauge per the manufacturer's recommended procedures.

Table 2: Minimum Number of Rollers Recommended Based on Placement Rate

Average Laydown Rate, Square Yards per Hour	Number of Rollers Required (a)	
	Compaction	Finish
Less than 600	1	1 (b)
601 - 1200	1	1
1201 - 2400	2	1
2401 - 3600	3	1
3601 and More	4	1

a. Number of rollers may increase based on density frequency curve.
b. The compaction roller may be used as the finish roller also.

After placement, roll the HMA mixture as soon after placement as the roller is able to bear without undue displacement or cracking. Start rolling longitudinally at the sides of the lanes and proceed toward the center of the pavement, overlapping on successive trips by at least half the width of the drum. Ensure each required roller is 8 tons minimum in weight unless otherwise approved by the Engineer.

Ensure the initial breakdown roller is capable of vibratory compaction and is a maximum of 500 feet behind the paving operations. The maximum allowable speed of each roller is 3 miles per hour (mph) or 4.5 feet per second. Ensure all compaction rollers complete a minimum of two complete rolling cycles prior to the mat temperature cooling to 180 degrees Fahrenheit (F). Continue finish rolling until all roller marks are eliminated and no further compaction is possible. The Engineer will verify and document that the roller pattern has been adhered to. The Engineer can stop production when the roller pattern is not adhered to.

d. Measurement and Payment. The completed work, as described, will be measured and paid for using applicable pay items as described in subsection 501.04 of the Standard Specifications for Construction, or the contract, except as modified below.

Base Price. Price established by the Department to be used in calculating incentives and adjustments to pay items and shown in the contract.

If acceptance tests, as described in section c. of this special provision, show that a Table 1 mixture parameter exceeds the Range 1, but not the Range 2, tolerance limits, that mixture parameter will be subject to a 10 percent penalty. The 10 percent penalty will be assessed based on the acceptance tests only unless the Contractor requests that the 10,000 gram sample part retained for possible dispute resolution testing be tested. The Contractor has 4 calendar days from receipt of the acceptance test results to notify the Engineer, in writing, that dispute resolution testing is requested. The Contractor's QC test results for the corresponding QA test results must result in an overall payment greater than QA test results otherwise the QA tests will not be allowed to be disputed. The Engineer has 4 calendar days to send the dispute resolution sample to the lab once dispute resolution testing is requested. The dispute resolution sample will be sent to an independent lab selected by the Local Agency, and the resultant dispute test results will be used to determine the penalty per parameter, if any. Ensure the independent lab is a MDOT QA/QC qualified lab or an AMRL HMA qualified lab. The independent lab must not have conflicts of interest with the Contractor or Local Agency. If the dispute testing results show that the mixture parameter is out-of-specification, the Contractor will pay for the cost of the dispute resolution testing and the contract base price for the material will be adjusted, based on all test result parameters from the dispute tests, as shown in Table 3 and Table 4. If the dispute test results do not confirm the mixture parameter is out-of-specification, then the Local Agency will pay for the cost of the dispute resolution testing and no price adjustment is required.

If acceptance tests, as described in section c. of this special provision, show that a Table 1 mixture parameter exceeds the Range 2 tolerance limits, the 10,000 gram sample part retained for possible dispute resolution testing will be sent, within 4 calendar days, to the MDOT Central Laboratory for further testing. The MDOT Central Laboratory's test results will be used to determine the penalty per mixture parameter, if any. If the MDOT Central Laboratory's results do not confirm the mixture parameter is out-of-specification, then no price adjustment is required. If the MDOT Central Laboratory's results show that the mixture is out-of-specification and the Engineer approves leaving the out-of-specification mixture in place, the contract base price for the material will be adjusted, based on all parameters, as shown in Table 3 and Table 4.

In the case that the Contractor disputes the results of the test of the second sample obtained for a particular day of production, the test turn-around time frames given would apply to the second test and there would be no time frame on the first test.

The laboratory (MDOT Central Laboratory or independent lab) will complete all Dispute Resolution testing and return test results to the Engineer, who will provide them to the Contractor, within 13 calendar days upon receiving the Dispute Resolution samples.

In all cases, when penalties are assessed, the penalty applies to each parameter, up to two parameters, that is out of specification.

Table 3: Penalty Per Parameter

Mixture Parameter out-of-Specification per Acceptance Tests	Mixture Parameter out-of-Specification per Dispute Resolution Test Lab	Price Adjustment per Parameter
NO	N/A	None
YES	NO	None
	YES	Outside Range 1 but not Range 2: decrease by 10%
		Outside Range 2: decrease by 25%

The quantity of material receiving a price adjustment is defined as the material produced from the time the first out-of-specification sample was taken until the time the sample leading to the first in-specification test was taken.

Each parameter of Table 1 is evaluated with the total price adjustment applied to the contract base price based on a sum of the two parameter penalties resulting in the highest total price adjustment as per Table 4. For example, if three parameters are out-of-specification, with two parameters outside Range 1 of Table 1 tolerance limits, but within Range 2 of Table 1 limits and one parameter outside of Range 2 of Table 1 tolerance limits and the Engineer approves leaving the mixture in place, the total price adjustment for that quantity of material is 35 percent.

Table 4: Calculating Total Price Adjustment

Cost Adjustment as a Sum of the Two Highest Parameter Penalties		
Number of Parameters Out-of-Specification	Range(s) Outside of Tolerance Limits of Table 1 per Parameter	Total Price Adjustment
One	Range 1	10%
	Range 2	25%
Two	Range 1 & Range 1	20%
	Range 1 & Range 2	35%
	Range 2 & Range 2	50%
Three	Range 1, Range 1 & Range 1	20%
	Range 1, Range 1 & Range 2	35%
	Range 1, Range 2 & Range 2	50%
	Range 2, Range 2 & Range 2	50%

Table 5: Density Frequency Curve Development

Tested by: _____ Date/Time: _____

Route/Location:		Air Temp:
Control Section/Job Number:		Weather:
Mix Type:	Tonnage:	Gauge:
Producer:	Depth:	Gmm:

Roller #1 Type:

Pass No.	Density	Temperature	Comments
1			
2			
3			
4			
5			
6			
7			
8			
Optimum			

Roller #2 Type:

Pass No.	Density	Temperature	Comments
1			
2			
3			
4			
5			
6			
7			
8			
Optimum			

Roller #3 Type:

Pass No.	Density	Temperature	Comments
1			
2			
3			
4			
5			
6			
7			
8			
Optimum			

Summary: _____

MICHIGAN
DEPARTMENT OF TRANSPORTATION

SPECIAL PROVISION
FOR
**QUALITY CONTROL AND ACCEPTANCE OF STRUCTURAL PRECAST
CONCRETE**

OFS:MJF

1 of 10

APPR:JFS:POJ:07-20-16
FHWA:APPR:08-12-16

a. Description. The Contractor must administer quality control (QC) and the Department will administer quality assurance (QA) procedures that will be used for acceptance of and payment for all Portland cement concrete (PCC) used to fabricate structural precast (prestressed and non-prestressed) concrete elements. This special provision applies to the following structural precast concrete elements that are required to be accepted based on "Fabrication Inspection" per MDOT's Materials Quality Assurance Procedures (MQAP) manual or per project specifications:

- Bridge beams;
- Culverts (10 foot span lengths and greater measured parallel to the roadway centerline);
- Prefabricated bridge elements and systems;
- Mechanically stabilized earth wall;
- Spun concrete poles;
- Sound walls; and
- Other elements as specified in project specifications.

Except as explicitly modified by this special provision, all materials, test methods, and PCC mixture requirements of the standard specifications and the contract apply.

Do not place PCC until the Engineer's daily startup testing verifies that the fresh PCC properties have been met, in accordance with subsection d.2 of this special provision.

Provide the Engineer with 7 calendar days notification prior to the start of fabrication, unless a longer notification period is specified in the contract. Additionally, provide the Engineer with adequate prior notification, as determined at the prefabrication meeting, prior to placement of PCC. Inadequate prior notification may result in rejection of the element due to lack of quality assurance verification inspection.

The following definitions apply when used herein:

Air Content of Fresh Portland Cement Concrete. The recorded air content of fresh PCC sampled and tested according to this special provision.

Alkali-Silica Reactivity (ASR). A chemical reaction which occurs over time within PCC between highly alkaline cement paste and reactive forms of silica found in some aggregates. In the presence of moisture, an expansive ASR gel is formed which can exert pressure within the PCC, causing random cracking and premature deterioration of the PCC. See subsection c.5.A of this special provision.

Job Mix Formula (JMF). The actual batch quantities (mixture proportions) of each constituent

included in the PCC mixture, based on adjustments to the target weights attained from the mix design process necessary to optimize the PCC mixture properties.

Portland Cement Concrete Mix Design. The process, by which the PCC mixture performance characteristics are defined, based on selected materials, performance requirements, environmental exposure considerations, placement methods, and other factors that control the plastic and hardened properties of the PCC in efforts to produce an economical and durable product.

Production Lot. A discrete cubic yard quantity of PCC containing the same JMF and used for the same application as described in subsection c.5.F of this special provision.

Quality Assurance (QA). Activities administered by the Department dealing with acceptance of the product, including, but not limited to, materials selection, sampling, testing, fabrication inspection, and review of Contractor QC documentation. All PCC QA sampling and testing will be administered by the Engineer. Department administered QA is described in section d of this special provision.

Quality Control (QC). All activities administered by the Contractor to monitor, assess, and adjust production and fabrication processes to ensure the final product will meet the specified levels of quality, including, but not limited to, training, materials selection, sampling, testing, project oversight and documentation. Contractor administered QC is described in section c of this special provision.

QC Action Limits. A range of values established by the Contractor in the QC plan that if exceeded, requires that corrective action be taken by the Contractor to restore the continuity and uniformity of the mixture and methods in conformance with specification requirements. The QC action limits must not exceed the QC suspension Limits.

QC Plan. The plan developed by the Contractor describing, in detail, all aspects of production and fabrication for the project to ensure consistent control of quality to meet specification requirements.

QC Manager. An employee of, or consultant engaged by the Contractor, responsible for developing and overseeing all aspects of QC for the project. This includes, but is not limited to preparing the QC plan, managing all QC personnel, communicating routinely with the production personnel to ensure quality, initiating corrective action and suspending operations when the process is found to be producing non-conforming materials, and preparing and submitting all necessary QC documentation to the Engineer within the specified time period.

QC Suspension Limits. A range of values that if exceeded on a single QC test, requires that the Contractor suspend operations and determine, correct, and document the deficiencies before resuming production. The QC suspension limit must not exceed specification limits.

Sample. A representative quantity of PCC taken during production which is used to measure the quality characteristics for the PCC.

Sampling Rate. The number of times the fresh PCC is sampled.

Specification Limits. The threshold values placed on a quality characteristic used to evaluate the quality of the material.

Strength Sample Test Result. The average of two or three companion 28-day compressive strength test specimens for non-prestressed structural precast concrete and prestressed structural precast concrete, respectively, taken from the same sample of PCC is considered a strength sample test result.

Strength Test Specimen. A strength test specimen is an individual 6-inch by 12-inch strength test cylinder or 4-inch by 8-inch strength test cylinder molded and cured according to *AASHTO T 23/ASTM C 31* and tested according to *AASHTO T 22/ASTM C 39*. All QC strength test specimens must be the same nominal size. Strength test specimen cylinder size of 4-inch by 8-inch is permitted only if the nominal maximum coarse aggregate particle size, as specified for the coarse aggregate in the PCC mixture, is 1-inch or less.

Sublot. A portion of a production lot represented by a complete set of QC tests, as described in subsection c.5.F of this special provision. The Engineer and Contractor may agree to reduce the typical subplot size based on other project conditions.

b. Materials. Mixture requirements must be in accordance with the contract.

c. Contractor Administered Quality Control (QC).

1. Contractor Quality Control Plan (QC Plan). Prepare, implement, and maintain a QC plan for PCC, in accordance with applicable plant certification requirements shown in the contract, which will provide quality oversight for production, testing, and control of fabrication processes. The QC plan must be in conformance with the contract and must identify all procedures used to control production and placement including when to initiate corrective action necessary to maintain the quality and uniformity of the work.

Develop PCC mix designs and JMFs, as specified, and conduct QC sampling, testing, and inspection during all phases of the PCC work at the minimum frequency, or at an increased frequency sufficient to ensure that the work conforms to specification requirements.

2. QC Records. Maintain complete records of all QC tests and inspections. Include sufficient information to allow the test results to be correlated with the items of work represented. Document what action was taken to correct deficiencies.

Furnish one copy of all QC records, including test reports for the fresh PCC placement, to the Engineer within 24 hours after the date covered by the record in a format acceptable to the Engineer. The Engineer will withhold acceptance of the PCC for failure to provide properly documented and timely QC records and reports.

3. Personnel Requirements. The QC Manager must have full authority and responsibility to take all actions necessary for the successful implementation of the QC plan, including but not limited to, the following:

A. Monitoring and utilizing QC tests, control charts, and other QC practices to ensure that delivered materials and proportioning meets specification requirements.

B. Monitoring all materials prior to their use, to ensure their continued compatibility toward producing consistent quality.

- C. Periodically inspecting all equipment utilized in transporting, proportioning, mixing, placing, consolidating, finishing, and curing to ensure proper operation.
- D. Monitoring materials stockpile management, PCC batching, mixing, transporting, placement, consolidation, finishing, and curing to ensure conformance with specification requirements.
- E. Maintaining and submitting all QC records and reports to the Engineer.
- F. Directing the necessary corrective action to ensure continual conformance within specification limits.
- G. Conducting or monitoring adjustments to the JMF.
- H. Observing PCC placement during the entire casting operation.

Individuals performing QC tests must demonstrate that they are proficient and capable of sampling and testing PCC or aggregate, where applicable, in accordance with the associated test procedures and Department requirements prior to commencement of related work. Any adjustments to the JMF must be made by a certified PCC technician [Michigan Concrete Association (MCA) Level II or Precast/Prestressed Concrete Institute (PCI) Level III].

Individuals performing concrete strength testing (performing, recording, and reporting) must possess a valid MCA Level I Field Testing or American Concrete Institute (ACI) Concrete Strength Testing Technician certification, except the period of effectiveness for the ACI certification is reduced from 5 years to 3 years.

4. QC Laboratory Requirements. Laboratories, including field laboratories and all associated testing equipment that prepare PCC mixes or perform QC testing, must demonstrate to the Engineer that they are equipped, staffed, calibrated, and managed so as to be capable of batching and testing PCC in accordance with the applicable test methods and procedures. Mix designs and their accompanying JMFs must include a statement, signed by a certified PCC technician (MCA Michigan Level II) or PCI Level III, that all applicable standard test methods have been followed in verifying the mix design and JMF.

5. Mix Design and Documentation. Design PCC mixtures meeting the requirements specified in the contract. Request variance in writing when proposing a mix design that exhibits temperature, slump or air content other than those specified. Include the proposed mix design, JMF, and associated trial batch verification test data.

Non-prestressed structural precast concrete mixtures using Type III Portland cement must contain 25 to 40 percent replacement of the Portland cement in the PCC mixture with slag cement (Grade 100 minimum) or fly ash.

Do not replace more than 40 percent of the Portland cement in the PCC mixture with slag cement (Grade 100 minimum) or fly ash. Do not exceed 40 percent total replacement of the Portland cement if both slag cement and fly ash are used in the PCC mixture.

- A. Alkali-Silica Reactivity. Provide documentation to the Engineer that the PCC mixture does not present the potential for excessive expansion caused by alkali-silica reactivity (ASR). Provide current ASR test results (valid for 2 years from completion of

testing), for the fine aggregate that is proposed to be used in the PCC, from an independent testing laboratory proficient in ASR testing. The independent testing laboratory must certify in writing, including a signed statement that all testing was conducted in accordance with the designated standard test procedures, described herein. Test results must conform to the specified criterion for one of the following standard test methods. Use the Rounding Method described in *ASTM E 29* when determining significant digits for reporting expansion test results.

(1) Method 1. *ASTM C 1260*. Mortar Bar Test. If the expansion of the mortar bars is less than 0.10 percent (rounded to the nearest 0.01 percent) at 14 days of immersion, the fine aggregate is considered non-deleterious to ASR and may be used in the PCC without the need for ASR mitigation.

(2) Method 2. *ASTM C 1293*. Concrete Prism Test.

(a) If the expansion of PCC prisms is not greater than 0.040 percent (rounded to the nearest 0.001 percent) after 1 year, the fine aggregate is considered non-deleterious to ASR and may be used in the PCC without the need for ASR mitigation.

(b) If the expansion of PCC prisms is greater than 0.040 percent, but not exceeding 0.120 percent (rounded to the nearest 0.001 percent) after 1 year, the fine aggregate is considered moderately deleterious to ASR and mitigation is required, as follows: A low-alkali cement with Na₂O equivalent alkalis (Na₂O + 0.658 × percent K₂O) not exceeding 0.60 percent must be used in the PCC mixture to mitigate the potential for ASR. Slag cement or fly ash may be used in conjunction with the low-alkali cement. The total alkali content for the cementitious materials combination must not exceed 3.0 pounds per cubic yard of Na₂O equivalent.

(3) Method 3. *ASTM C 1567*. Mortar Bar Test. If no previous test data are available for the fine aggregate that shows it is resistant to ASR using either Method 1 or 2, above, replace 25 to 40 percent of the PCC in the PCC mixture with slag cement (Grade 100 minimum) or fly ash. A blended cement meeting the requirements of *ASTM C 595* containing PCC and slag cement or fly ash may also be used.

Demonstrate the ability of the slag cement or fly ash to control the deleterious expansion caused by ASR by molding and testing mortar bars according to the standard test method described in *ASTM C 1567* using the mix proportions and constituent sources for both the aggregates and the cementitious materials that will be used for the project. Make at least three test specimens for each cementitious materials-aggregate combination. If the average of three mortar bars for a given cementitious materials-aggregate combination produces an expansion less than 0.10 percent (rounded to the nearest 0.01 percent) at 14 days of immersion, the JMF associated with that combination will be considered non-deleterious to ASR. If the average expansion is 0.10 percent (rounded to the nearest 0.01 percent) or greater, the JMF associated with that combination will be considered not sufficient to control the deleterious expansion caused by ASR and the JMF will be rejected.

The Engineer will not approve the use of the JMF if the expansion exceeds the respective threshold limits for the respective *ASTM* test method used.

B. Contractor Provided Mixes. Provide mix design and accompanying JMFs using the methods of verification included in this special provision. Include sufficient information on constituent materials, trial batch verified physical properties of the fresh PCC, mix proportions per cubic yard for all constituents and compressive strength test results necessary to allow the Engineer to fully evaluate the expected performance of the PCC mixture.

(1) Mix Documentation. Prepare mix designs for each grade of PCC required on the project. Submit JMF for each mix design, including all required documentation, to the Engineer for review at least 10 working days before fabrication of structural precast concrete elements. The Engineer will notify the Contractor of any objections within 5 working days of receipt of the mix documentation. Identify each individual JMF and reference all accompanying documentation to this identification. Reference each JMF to the appropriate method of verification. Mix design and JMF submittals that do not include all required documentation will be considered incomplete and the Engineer will return them without review. Fabrication must not begin until the Engineer has and approved all required documentation.

Mix documentation is valid for 2 years.

All mix designs and accompanying JMFs must be traceable to a laboratory meeting the requirements of this special provision.

Submit mix design and JMF on the MDOT Job Mix Formula (JMF) Concrete Field Communication form (MDOT Form Number 1976); include accompanying documentation. List the source of materials, bulk density (unit weight) of coarse aggregate (rodding procedure or shoveling procedure), absorption of aggregates, relative density (specific gravity) of aggregates, aggregate correction factors, batch weights, and project specific or historical laboratory test data. Include the recorded air content of fresh PCC using the same admixture and cementitious material sources to be used in the production of the PCC for the project. A JMF will be approved only if all of the minimum mix design requirements specified in the contract have been met.

Four methods of verification of proposed JMF are acceptable.

(a) Method 1. Trial Batches. Verification of JMF is based on trial batches with the same materials and proportions proposed for use on the project. Prepare at least one trial batch for each mix design in sufficient time before starting PCC placement to allow for review according to subsection c.5.B.(1) of this special provision. Provide the results of temperature, slump, density (unit weight), air content of fresh PCC, 28-day compressive strength, and age of PCC at the time of strength testing, for a minimum of three independent samples. All samples may be taken from a single trial batch for a mix design provided the trial batch is at least four cubic yards in volume. For JMF trial batch verification purposes only, 7-day compressive strength test results which report at least 70 percent of the specified 28-day lower specification limit (LSL) will be sufficient documentation in lieu of 28-day compressive strengths. The average of at least two strength test specimens represents one compressive strength sample test result for each independent sample. Provide the necessary ASR documentation as described in subsection c.5.A of this special provision.

(b) Method 2. Same Mix. Verification of JMF is based on experience with the same mix design, JMF, and the same materials. Provide the results of temperature, slump, density (unit weight), air content of fresh PCC, 28-day compressive strength, and age of PCC at the time of strength testing, for a minimum of three independent samples. The average of at least two strength test specimens represents one compressive strength sample test result for each independent sample. Do not substitute material types or sources, including admixtures or cementitious materials, nor change mix proportions in the JMF. Provide the necessary ASR documentation as described in subsection c.5.A of this special provision.

(c) Method 3. Similar Mix. Verification of JMF is based on requirements described in method 2, above. Substitution of coarse and intermediate aggregate sources is permitted if the new source is of the same geologic type as the original aggregate, and conforms to the specification requirements for the application. Substitution of fine aggregate is permitted only if the new source has been tested for ASR. Provide the necessary ASR documentation as described in subsection c.5.A of this special provision.

Provide the supporting laboratory trial batch documentation and accompanying calculations showing how the mix proportions in the JMF were adjusted, based on the documented differences in relative density (specific gravity), bulk density (unit weight) and absorption of the substituted aggregate sources, to produce a theoretical yield of 100 percent and the required fresh PCC properties.

(d) Method 4. Annual Verification. At the Engineer's option, verification may be accepted annually for a PCC plant rather than on a project basis provided the sources and proportions of the constituent materials, including cementitious materials and source and types admixtures, do not change. If the project is the continuation of work in progress during the previous construction season and written certification is submitted to the Engineer that materials from the same source and with the same mixture properties are to be used, the Engineer may waive the requirement for annual renewal verification of the JMF for the project. Provide the necessary ASR documentation as described in subsection c.5.A of this special provision.

C. Changes in Materials and Proportions. Any change from one approved JMF to another for the same grade of PCC must be approved by the Engineer prior to PCC placement.

Prior to batching, verify that the proposed JMF changes will not affect the properties of the fresh PCC (slump, temperature, air content, density (unit weight), workability), nor result in excessive mortar bar expansion as a result of deleterious reactivity between the aggregates and cementitious materials as described in subsection c.5.A of this special provision.

Record all changes to JMF in the QC records along with the rationale for the change.

D. QC Sampling and Testing. Conduct startup sampling and testing for temperature, slump, density (unit weight), and air content on the first load. Do not place PCC until

testing verifies that the fresh PCC properties have not exceeded the action and suspension limit thresholds specified in the Contractor QC plan and the testing correlation requirements of subsection d.2 of this special provision have been met. Continue testing subsequent loads as described in the QC plan for each JMF. QC sampling and testing must be independent from the Department's QA sampling and testing.

PCC exceeding the maximum specification limits for slump or temperature must be rejected regardless of the total mixing time at the time of arrival to the forms.

The Engineer may require the Contractor to administer additional QC sampling and testing if the Engineer determines the Contractor's current QC sampling and testing methodology is shown to be insufficient to ensure continual control of the quality of the PCC.

Resume production only after making all necessary adjustments to bring the mixture into conformance with all applicable specifications. Document these adjustments in the QC records.

E. Work Progress Test Specimens. Cast work progress test specimens if elements are to be stripped, handled, shipped, detensioned, or similar operations prior to achieving 28-day compressive strength. Determine the strength of PCC for stripping forms, handling, and shipping elements in accordance with the design methodology used to design the element if these strength requirements are not provided by the Department. The Engineer may accept other industry recognized design codes if requested in writing and approved prior to fabrication. Match cure work progress test specimens in the same manner as the in-situ PCC. Allow the Engineer to witness testing of work progress test specimens.

F. Lot Size and Make Up. A production lot will not include more than one grade of PCC, PCC of the same grade having different specified slump or air content, or PCC of the same grade having different mix designs, or JMFs. See Table 1 for production lot size requirements for typical structural precast concrete elements.

G. Sampling. QC sampling will be as described in the Contractor QC plan in accordance to subsection c.1 of this special provision.

Table 1: Sublot Size Based on Casting Operation and Production Lot Size

Casting Operation	Production Lot Size	Sublot Size
Daily Production Bed Length (feet)	$0 < X \leq 400$	3
Culvert Segment Span Length (feet)(a)	$0 < X \leq 40$	1
Culvert Segment Span Length (feet)(a)	$40 < X \leq 60$	2
Non-prestressed Wall Area (square feet)	$0 < X \leq 1500$	3
Non-prestressed Wall Area (square feet)	$1500 < X \leq 2500$	4
a. Span length is measured parallel to the roadway centerline.		

d. Department Administered Quality Assurance (Acceptance).

1. Department Quality Assurance Plan (QA Plan). The Engineer will be responsible for administering the quality-based acceptance and will institute any actions necessary toward its successful implementation. The Engineer will follow MDOT's Materials Quality Assurance Procedures (MQAP) manual (4.04 Prestressed Structural Precast Concrete Fabrication or 4.11 Non-Prestressed Structural Precast Concrete) for QA fabrication inspection operations, including personnel requirements, and acceptance of the structural precast concrete elements.

2. Testing Correlation. The testing equipment and associated testing personnel for both the Engineer's QA testing and Contractor's QC testing must be used to conduct side by side correlation testing of the same PCC from the first load to verify correlation of both the Department's and the Contractor's test results for temperature and air content of fresh PCC. Side by side testing correlation must be conducted whenever there is a change in QC or QA equipment and/or personnel for the project, or as directed by the Engineer. The temperature measuring devices used for QC and QA must correlate relative to each other within 2 degrees Fahrenheit. If the air content results of two tests conducted between the Engineer's and the Contractor's testers differ by more than 0.8 percent air by volume of PCC, an air content test of fresh PCC must be conducted by QC using a third air meter, designated by the Engineer, but independent of the project, prior to commencement of PCC placement in an effort to resolve issues relative to non-correlation.

3. QA Sampling and Testing. The Engineer will verify the Contractor's daily startup sampling and testing of temperature, slump, and air content of fresh PCC on the first load; conduct QA sampling and testing; monitor Contractor adherence to the QC plan; and inspect placed materials in such a manner as to ensure that all PCC for the project is represented. The testing correlation requirements of subsection d.2 of this special provision must be met prior to PCC placement.

4. QA Stop Production Criteria. The Engineer will issue a Notice of Non-Compliance with Contract Requirements (Form 1165) and PCC production must stop when one or more of the following are observed.

- A. The QC plan is not being followed.
- B. Segregation or other notable changes in the fresh PCC properties is observed that may prevent proper placement, consolidation and finishing, or compromise the performance or long-term durability of the finished product.
- C. The required curing system is not being applied in a timely manner, as specified by the contract.

The Engineer will issue a Notice to Resume Work (Form 1165) only after all necessary adjustments are made to restore conformance with all applicable specifications, and the appropriate documentation is made in the QC records.

5. Acceptance. The Engineer will maintain a complete record of all QA tests and inspections. Acceptance will be based on MDOT's MQAP manual (4.04.06 Prestressed Structural Precast Concrete Fabrication or 4.11.06 Non-Prestressed Structural Precast Concrete).

e. Measurement and Payment. Separate payment will not be made for providing, implementing, and maintaining an effective QC program. All costs associated with this work will be included in the applicable unit prices for the structural precast concrete elements. Failure by the Contractor to maintain the proper curing environment for strength test specimens during initial and final cure will not be basis for claim against the Department.

MICHIGAN
DEPARTMENT OF TRANSPORTATION

SPECIAL PROVISION
FOR
GUARDRAIL ANCHORAGE BRIDGE, MODIFIED

DES:PAG

1 of 1

APPR:JAR:DBP:08-31-11
FHWA:APPR:08-31-11

a. Description. This work consists of constructing curved guardrail bridge anchorage with the curve radius shown on the plans and as directed by the Engineer.

b. Materials. Use materials as specified in section 807 of the Standard Specifications for Construction.

c. Construction. Construct the guardrail bridge anchorage in accordance with section 807 of the Standard Specifications for Construction and Standard Plan R-67 Series, except place the guardrail on a curve as shown on the plans.

d. Measurement and Payment. The completed work, as described, will be measured and paid for at the contract unit price using the following pay item:

Pay Item	Pay Unit
Guardrail Anch Bridge, Det __, Modified.....	Each

MICHIGAN
DEPARTMENT OF TRANSPORTATION

SPECIAL PROVISION
FOR
GUARDRAIL APPROACH TERMINAL TYPES 1B, 1T, 2B AND 2T

GRB:CT

1 of 2

APPR:CAL:DBP:06-01-16
FHWA:APPR:06-07-16

a. Description. This special provision will be used to supplement the information contained in MDOT Standard Plans R-61-Series and R-62-Series, respectively, and section 807 of the Standard Specifications of Construction.

Subject to the conditions specified in this special provision, the FLEAT-SP and SKT-SP guardrail approach terminals, respectively, manufactured by Road Systems, Inc., will be permitted as alternatives to the wood-post versions of the FLEAT and SKT guardrail approach terminals detailed in MDOT Standard Plans R-61-Series and R-62-Series, respectively.

b. Materials. Provide materials in accordance with section 807 of the Standard Specifications of Construction, MDOT Standard Plans R-61-Series, and MDOT Standard Plan R-62-Series, with the following additions:

1. Guardrail Approach Terminals Type 1B and 1T, respectively. The FLEAT-SP terminal, manufactured by Road Systems, Inc. may be provided as an alternative to the FLEAT terminal detailed in MDOT Standard Plan R-61-Series.
2. Guardrail Approach Terminals Type 2B and 2T, respectively. The SKT-SP terminal, manufactured by Road Systems, Inc. may be provided as an alternative to the SKT terminal detailed in MDOT Standard Plan R-62-Series.

Shop drawings for the FLEAT-SP and SKT-SP terminals, respectively, must be prepared by the guardrail terminal manufacturer, Road Systems, Inc., with details showing the terminal attached to MDOT Type B guardrail and Type T guardrail, respectively.

Obtain the Federal Highway Administration (FHWA) federal aid eligibility letter for the FLEAT-SP and SKT-SP terminal, respectively.

c. Construction. Provide shop drawings and FHWA eligibility letters for the FLEAT-SP and/or SKT-SP terminal, respectively, to the Engineer at least 14 days prior to terminal installation. The Engineer must review and approve the shop drawings and FHWA eligibility letter(s) prior to terminal installation.

Construct FLEAT-SP and SKT-SP guardrail terminals, respectively, in accordance with section 807 of the Standard Specifications for Construction, MDOT Standard Plan R-61-Series, MDOT Standard Plan R-62-Series, and as detailed on the shop drawings approved by the Engineer.

d. Measurement and Payment. The completed work for furnishing and installing a FLEAT-SP and/or SKT-SP terminal will be measured and paid for using the corresponding pay items for the FLEAT and SKT terminals, respectively, identified in MDOT Standard Plans R-61-Series and

GRB:CT

2 of 2

12SP-807J-01

06-01-16

R-62-Series, respectively. Additional payment will not be provided for preparing and submitting shop drawings and other documentation required for installing the FLEAT-SP and/or SKT-SP terminal.

MICHIGAN
DEPARTMENT OF TRANSPORTATION

SPECIAL PROVISION
FOR
PERMANENT PAVEMENT MARKINGS

PMK:MKB

1 of 3

APPR:MWB:CRB:06-21-17
FHWA:APPR:07-21-17

Add the following to the end of the list of materials in subsection 811.02, on page 588 of the Standard Specifications for Construction:

Modified Urethane Pavement Marking Material	920
Preformed Thermoplastic Pavement Marking Material	920

Ensure preformed thermoplastic materials have a thickness of 125 mils.

Add the following paragraph after the first paragraph of subsection 811.03.B, on page 589 of the Standard Specifications for Construction:

If pavement marking plan sheets and/or Witness, Log are included in the project the markings will be laid out by the Contractor prior to the permanent markings being applied. Layout is considered incidental to placement of permanent pavement markings. Provide the Engineer documented notice at least 2 calendar days prior to the Contractor pavement marking crew arriving onsite to layout and place the permanent pavement markings to enable the Engineer or a representative being onsite for review of the layout prior to the marking application. Notify the Engineer if it is discovered during layout that the pavement width or geometry has been altered or is different from the planned or logged configuration. The Contractor and Engineer will discuss and document the resolution for marking layout in such areas. If pavement marking plans and/or Witness, Log are not in the project, it is the responsibility of the Engineer to provide layout for the permanent pavement markings.

Add the following row to Table 811-1 of subsection 811.03.B, on page 591 of the Standard Specifications for Construction:

Polyurea	20	Binder (gal)	5.5	8.25	11	17	22	33	44	66
		Bead (lb)	As directed by the manufacturer							
Modified Urethane	20	Binder (gal)	5.5	8.25	11	17	22	33	44	66
		Bead (lb)	As directed by the manufacturer							

Add the following paragraph after the fifth paragraph on page 592 of subsection 811.03.B, of the Standard Specifications for Construction:

Beads are not to be placed in liquid shadow markings.

Add the following subsections after the last paragraph of subsection 811.03.D.7.c, on page 595 of the Standard Specifications for Construction:

8. **Modified Urethane.** Ensure the pavement is free of excess surface and subsurface moisture that may affect bonding. The Engineer will not decide the suitability of specific days for the application of modified urethane.

Surface preparation requirements for special, and longitudinal modified urethane pavement markings depend on surface conditions.

Prepare new HMA surfaces and HMA surfaces open to traffic for 10 days or less with no oil drips, residue, debris, or temporary or permanent markings, by cleaning the marking area with compressed air.

Prepare new PCC surfaces and PCC surfaces free of oil drips, residue, and debris, temporary, or permanent markings, by removing the curing compound from the area required for pavement markings.

Prepare existing HMA or PCC surfaces that do not have existing markings, but may have oil drip areas, debris, or both, by scarifying the marking area using non-milling grinding teeth or shot blasting. The Engineer will allow the use of water blasting to scarify the marking area on PCC surfaces.

Prepare existing HMA or PCC surfaces with existing pavement markings and that may have oil drip areas, debris, or both, by using the following methods:

- a. For existing liquid pavement markings, scarify the proposed marking area using non-milling grinding teeth or shot blast. Occasionally existing liquid pavement markings will require complete removal, which will be determined by the Engineer.
 - b. For existing cold plastic markings, completely remove the existing markings.
9. **Preformed Thermoplastic.** Ensure the pavement is free of excess surface and subsurface moisture that may affect bonding. The Engineer will not decide the suitability of specific days for the application of preformed thermoplastic.

Heat and apply the preformed thermoplastic material as recommended by the manufacturer. Feather all edges of the material with a putty knife while the preformed thermoplastic is still soft.

Add the following rows to Table 811-2 of subsection 811.03.D, on page 596 of the Standard Specifications for Construction:

Modified Urethane	40	40	Apr. 15	Nov. 15
Preformed Thermoplastic	35	35	Apr. 15	Nov. 15

Add the following pay items to the list of pay items in subsection 811.04, on page 598 of the Standard Specifications for Construction:

Pavt Mrkg, Modified Urethane, (symbol).....Each
Pavt Mrkg, Modified Urethane, (legend)Each
Pavt Mrkg, Modified Urethane, ___ inch, CrosswalkFoot
Pavt Mrkg, Modified Urethane, ___ inch, Stop BarFoot
Pavt Mrkg, Modified Urethane, ___ inch, Cross Hatching (color).....Foot
Pavt Mrkg, Modified Urethane, ___ inch, (color).....Foot
Pavt Mrkg, Ovly Cold Plastic, ___ inch, Shadow Tape, Black.....Foot
Pavt Mrkg, Ovly Cold Plastic, ___ inch, Wet Reflective, (color)Foot
Pavt Mrkg, Preformed Thermoplastic, (symbol)Each
Pavt Mrkg, (binder), ___ inch, Shadow Liquid, Black.....Foot

MICHIGAN
DEPARTMENT OF TRANSPORTATION

SPECIAL PROVISION
FOR
TRAFFIC CONTROL QUALITY AND COMPLIANCE

OPR:JJG

1 of 2

APPR:CER:DBP:01-20-11
FHWA:APPR:06-20-11

Delete the subsection 812.03.C, Deficient Traffic Control Operations on page 601 of the Standard Specifications for Construction in its entirety, and replace with the following.

C. Deficient Traffic Control Operations.

1. Traffic Control Quality and Compliance. The following applies to all aspects of the traffic control plan and traffic control devices except the Type D lights on plastic drums which are covered elsewhere in the contract.

a. Traffic Control not Anticipated in Design. If at any time during the project, including the time during the seasonal suspension, the Engineer documents that the traffic control requires improvements beyond the scope of the Traffic Control Plan, the Engineer will provide written instructions to the Contractor and traffic control supplier what improvements are required. The Contractor must develop and submit to the Engineer for approval, a written implementation schedule for improvements. If the schedule is not approved, or if the schedule is approved but is not followed, the Department will adjust the contract according to subsection 812.03.C.1.c.iii. If the implementation schedule is not followed, the Engineer will notify the Contractor and traffic control supplier in writing that they are in violation of this subsection. The work of making traffic control improvements directed by the Engineer that are beyond the scope of the Traffic Control Plan will be paid for as extra work.

b. As Designed Traffic Control. If at any time during the project, including the time during the seasonal suspension, the Engineer documents that the traffic control is deficient, inadequate or improperly placed, the Engineer will provide written notification with instructions for corrective action to the Contractor and traffic control supplier. Upon receipt of the notification of corrective action, the Contractor has 4 hours to correct the traffic control. If the traffic control cannot be corrected within the 4 hour time period, the Contractor will develop a written implementation schedule for the corrective action and submit the schedule to the Engineer for approval within 1 hour of receiving the written notification. If the schedule is not approved, or if the schedule is approved but is not followed, the Department will adjust the contract according to subsection 812.03.C.1.c.iii. If the implementation schedule is not followed, the Engineer will notify the Contractor and traffic control supplier in writing that they are in violation of this subsection.

c. Corrective Action. The Engineer will give written notification to the Contractor as identified above. Failure to make corrections within the timeframe required may result in the following actions by the Engineer:

- i. Stop work on the project until the Contractor completes corrective action,
- ii. Order corrective action by others in accordance with subsection 107.07, subsection 108.02, subsection 812.03.B, and in the interest of public safety.
- iii. A contract price adjustment will be made in the amount of \$100 per hour for every hour or portion thereof the improvements or corrective action remains incomplete as described herein. If improvements or corrections have not been made to the satisfaction of the Department, the contract will be adjusted until the traffic control is acceptable.

MICHIGAN
DEPARTMENT OF TRANSPORTATION

SPECIAL PROVISION
FOR
**MINOR TRAFFIC DEVICES AND TRAFFIC REGULATOR CONTROL DURING AN
APPROVED EXTENSION OF TIME**

OPR:CRB

1 of 1

APPR:JJG:DBP:09-27-12

FHWA:APPR:10-04-12

Delete the first sentence of the second paragraph in subsection 812.04.U, Price Adjustments for Authorized Extensions of Time, on page 631 of the Standard Specifications for Construction and replace with the following.

The Department will not make price adjustments for temporary traffic control devices, Minor Traf Devices, and Traf Regulator Control during authorized extensions of time if liquidated damages are assessed in accordance with subsection 108.08 and subsection 108.09.

Delete the third paragraph and Formula 812-1 of subsection 812.04.U, Price Adjustments for Authorized Extensions of Time, on page 631 of the Standard Specifications for Construction, that starts with “The Department will use the following formula...” and replace with the following.

The Department will use the following formula to calculate the unit price adjustments. The adjustment for Minor Traf Devices will be at a daily rate of (a/b) not to exceed \$900.00 per calendar or work day and the adjustment for Traf Regulator Control will be at a daily rate of (a/b) not to exceed \$650.00 per calendar or work day. When calculating the adjustment, either calendar or working days will be used for both original contract time and additional days.

$a/b \times c =$ Unit price adjustment

Formula 812-1

where:

a = Original contract unit price.

b = Original contract time (For calendar date projects the original contract time will be calculated as the number of calendar days from the start date to the contract completion date as identified on the progress schedule, form 1130).

c = Additional days the item was in use or required to be on standby during the authorized extension of time.

MICHIGAN
DEPARTMENT OF TRANSPORTATION

SPECIAL PROVISION
FOR
PAYMENT FOR MINOR TRAFFIC DEVICES AND TRAFFIC REGULATOR CONTROL

OPR:JJG

1 of 1

APPR:BJO:DBP:07-19-11
FHWA:APPR:07-19-11

Delete Table 812-1 in subsection 812.04.E, on page 625 of the Standard Specifications for Construction, in its entirety and replace with the following.

Table 812-1 Partial Payment Schedule for Minor Traf Devices and Traffic Regulator Control

Percent of Original Contract Amount Earned	Total Percent of Unit Price Paid
First Use	15
25	30
50	55
75	80
90	100

MICHIGAN
DEPARTMENT OF TRANSPORTATION

SPECIAL PROVISION
FOR
SUPPORTS FOR TEMPORARY SIGNS

OPR:CRB

1 of 1

APPR:MWB:DBP:06-26-12
FHWA:APPR:08-18-12

Delete the last paragraph of subsection 812.03.D.3, on page 604 of the Standard Specifications for Construction in its entirety, and replace with the following.

Mount construction signs on portable sign support standards only if signs are to remain in place for 14 days or less, or as allowed by the Engineer if fixed supports are not possible.

MICHIGAN
DEPARTMENT OF TRANSPORTATION

SPECIAL PROVISION
FOR
LONGITUDINAL PAVEMENT MARKING REMOVAL

OFS:CGB

1 of 2

APPR:MWB:JJG:02-26-14
FHWA:APPR:03-13-14

Delete subsection 812.03.F, on pages 615 and 616 of the Standard Specifications for Construction, in its entirety and replace it with the following:

F. Pavement Marking Removal. Remove pavement markings that conflict with proposed temporary traffic markings before making any changes in the traffic pattern. Place temporary pavement markings when pavement markings are removed or obscured for more than 24 hours before a change in the traffic pattern. Type R markings must be placed according to subsection 812.03.D.11 before the close of the workday.

Remove pavement markings using self-propelled truck mounted removal equipment. Use equipment capable of continuously vacuuming up the removal debris as the operation progresses. Immediately clean up and remove any debris that is generated. If the amount of debris generated during the removal process is greater than the vacuuming capability of the removal truck, a self-propelled sweeper operating immediately behind the removal equipment is required. Use a removal truck capable of eliminating the airborne dust while operating.

Remove pavement markings causing as little damage as possible to the surface texture of the pavement and by methods approved by the Engineer. Methods and equipment that may provide acceptable results are: shot blasting; water blasting; mechanical devices such as grinders, scarifiers, and wire brushes.

1. Asphalt Surfaces. Use any Engineer approved type of self-propelled truck mounted removal equipment except water blasting, provided that the equipment is capable of continually vacuuming the removal debris.

2. Concrete Surfaces to be Removed During Construction. Use any Engineer approved type of self-propelled truck mounted removal equipment provided that the equipment is capable of continually vacuuming the removal debris.

3. Concrete Surfaces to Remain in Place. Use an Engineer approved self-propelled truck mounted water blaster to minimize the scarring of the concrete surface. Use equipment capable of continually vacuuming the removal debris as approved by the Engineer.

Do not use paint or bituminous bond coat to cover existing and not applicable pavement markings. Use Type R markings only when authorized by the Engineer.

Add the following pay items to the Pay Item list in subsection 812.04, on pages 622 and 623 of the Standard Specifications for Construction:

Pavt Mrkg, Longit, Water Blasting, 6 inch or less Width, Rem	Foot
Pavt Mrkg, Longit, Water Blasting, Greater than 6 inch Width, Rem	Foot

Delete the first paragraph of subsection 812.04.N.1, on pages 628 and 629 of the Standard Specifications for Construction, in its entirety and replace it with the following:

1. **General.** The Department will pay for the removal of longitudinal markings as directed by the Engineer on all HMA surfaces and on concrete surfaces to be removed as **Pavt Mrkg, Longit, Rem**, of the width required. The unit prices for **Pavt Mrkg, Longit, Rem** pay items include the cost of removing existing longitudinal permanent markings and temporary Type NR markings, including tapers and transitions.

The Department will pay for the removal of longitudinal markings on concrete surfaces to remain in place as **Pavt Mrkg, Longit, Water Blasting, Rem**, of the width required. The unit prices for **Pavt Mrkg, Longit, Water Blasting, Rem** pay items include the cost of removing existing longitudinal permanent markings and temporary Type NR markings, including tapers, and transitions.

MICHIGAN
DEPARTMENT OF TRANSPORTATION

SPECIAL PROVISION
FOR
PAYMENT OF TEMPORARY TRAFFIC CONTROL DEVICES

OFS:CRB

1 of 1

APPR:CGB:MB:08-26-16
FHWA:APPR:09-13-16

Delete subsection 812.04.A Damage Compensation, on page 623 of the Standard Specifications for Construction, in its entirety and replace with the following:

A. Damage Compensation. Notify the Engineer of damaged temporary traffic control devices. Before replacement and disposal, allow the Engineer to verify the condition of damaged temporary traffic control devices eligible for payment. Damage will be assumed to have occurred from vehicular traffic unless otherwise documented. The Department will pay as follows, for replacing temporary traffic control devices or equipment that are placed appropriately and damaged by vehicular traffic, other than the Contractor's vehicles and equipment.. Devices will be assumed to be placed appropriately unless otherwise documented. Replacement will be made up to project completion (excluding water and cultivating), as follows:

1. The **Furnished** unit price for temporary traffic control devices paid for as furnished pay items, excluding Plastic Drums and 42 inch channelizing devices;
2. The unit price for devices not paid for as **Furnished**;

- a. Plastic Drums and 42 inch Channelizing Devices will be paid for at a set rate of \$35 per Plastic Drum and \$18 per damaged 42 inch Channelizer.
 - i. Prior to payment the Plastic Drum or 42 inch Channeling Device must be classified as unacceptable, per the ATSSA Quality Guidelines for Temporary Traffic Control Devices and Features (ATSSA QG), and spray-painted with an X.
 - ii. All Plastic Drums and 42 inch Channelizing Devices that are classified as marginal, per the ATSSA QG, during the project, will have blue survey ribbon tied to the handle. MDOT will be responsible for marking marginal devices. Removal and replacement will take place as defined under the Quality Classifications and Requirements Section of the ATSSA QG and will be at no additional cost to the Department.

If at any time, any Contactor, is witnessed tampering with the marginal marking method, the Engineer may require all marginal devices on the project to be upgraded to acceptable outside the timeframes detailed in the ATSSA QG.

3. The manufacturer's invoice cost for devices required by the Engineer and not included in the unit price for other relevant pay items;
4. The manufacturer's invoiced cost for damaged equipment included in a lump sum pay item for maintaining traffic.

MICHIGAN
DEPARTMENT OF TRANSPORTATION

SPECIAL PROVISION
FOR
INDUSTRIAL BY-PRODUCTS AND BENEFICIAL RE-USE

ENV:HLZ

1 of 1

APPR:JJG:JFS:09-11-14

APPR: FHWA: 09-11-14

a. Description. For this project, regardless of the application, the use of industrial by-products, covered in 2014 PA 178, is prohibited unless the use and application of a particular material is covered elsewhere in the contract.

MICHIGAN
DEPARTMENT OF TRANSPORTATION

SPECIAL PROVISION
FOR
CRUSHED CONCRETE NEAR WATER

CFS:JFS

1 of 1

APPR:KAS:DBP:02-24-12
FHWA:APPR:02-24-12

Add the following paragraph after the first paragraph of Subsection 902.05 on page 743 of the Standard Specifications for Construction:

The use of crushed concrete is prohibited on the project within 100 feet of any water course (stream, river, county drain, etc.) and lake, regardless of the application or location of the water course or lake relative to the project limits.

Add the following paragraph after the first paragraph of Subsection 902.06 on page 743 of the Standard Specifications for Construction:

The use of crushed concrete is prohibited on the project within 100 feet of any water course (stream, river, county drain, etc.) and lake, regardless of the application or location of the water course or lake relative to the project limits.

Add the following paragraph after the fourth paragraph of Subsection 902.07 on page 744 of the Standard Specifications for Construction:

The use of crushed concrete is prohibited on the project within 100 feet of any water course (stream, river, county drain, etc.) and lake, regardless of the application or location of the water course or lake relative to the project limits.

MICHIGAN
DEPARTMENT OF TRANSPORTATION

SPECIAL PROVISION
FOR
ELECTRICAL AND LIGHTING CONDUIT

UTL:SJU

1 of 1

APPR:MWB:LWB:01-13-15
FHWA:APPR:01-27-15

Delete the first sentence in subsection 918.01, on page 857 of the Standard Specifications for Construction, and replace with the following:

Provide conduits listed and appropriately labeled by a Nationally Recognized Testing Laboratory (NRTL), as recognized by the Occupational Safety and Health Administration (OSHA), with ultraviolet protection and manufactured for use at temperatures of at least 194 degrees F unless otherwise required.

Delete the second sentence in subsection 918.01.A, on page 857 of the Standard Specifications for Construction, and replace with the following:

Provide galvanized steel conduit manufactured in accordance with UL 6.

MICHIGAN
DEPARTMENT OF TRANSPORTATION

SPECIAL PROVISION
FOR
PERMANENT PAVEMENT MARKING MATERIALS

PMK:MKB

1 of 1

APPR:MWB:CRB:07-07-16

FHWA:APPR:07-13-16

Delete the first paragraph of subsection 920.01, on page 890 of the 2012 Standard Specifications for Construction in its entirety and replace it with the following:

Select pavement marking materials from the Qualified Products List unless specified otherwise by special provision in the contract. For black liquid shadow markings and blue markings used in parking areas, either choose a product of the specified binder material and color from the Qualified Products List or select a white product of the specified binder material from the Qualified Products List and tint the product to the appropriate color.

Use liquid applied pavement marking materials manufactured in the previous 12 months or within the shelf-life directed by the manufacturer, whichever is less. Use solid applied materials within the shelf-life directed by the manufacturer. Provide certification that liquid and solid applied pavement marking materials have been stored per the manufacturer's requirements. Materials not in compliance will be rejected and removed at the Contractor's expense.

Delete the second paragraph from subsection 920.02.A, on page 891 of the Standard Specifications for Construction in its entirety and replace it with the following:

Glass beads must meet the general requirements of subsection 920.02.B, and the applicable requirements for specific applications of subsection 920.02.C. All glass beads meeting subsections 920.02.B and 920.02.C to be used on Federal-aid projects must contain no more than 200 parts per million of arsenic or lead, as determined in accordance with *Environmental Protection Agency* testing methods 3052, 6010B, or 6010C.

Add the following after the last paragraph of subsection 920.02.C, on page 892 of the 2012 Standard Specifications for Construction:

6. **Modified Urethane.** The type, gradation, and application rates for glass beads used with modified urethane marking material must meet the modified urethane manufacturer's recommendation.

Use a double drop system of large and standard glass beads, a double drop system of ceramic elements and standard glass beads, or an Engineer-approved alternate for recessed longitudinal markings. Ensure large glass beads meet federal specification TTB-1325 for a Type 4 glass bead.

MICHIGAN
DEPARTMENT OF TRANSPORTATION

SPECIAL PROVISION
FOR
GLASS BEADS USED FOR PAVEMENT MARKINGS

PMK:MKB

1 of 1

APPR:MWB:HZ:10-26-12
FHWA:APPR:11-05-12

Delete the second paragraph from subsection 920.02.A, on page 891 of the Standard Specifications for Construction in its entirety and replace it with the following:

Glass beads must meet the general requirements of subsection 920.02.B, and the applicable requirements for specific applications of subsection 920.02.C. All glass beads meeting subsections 920.02.B and 920.02.C to be used on Federal-aid projects must contain no more than 200 parts per million of arsenic or lead, as determined in accordance with *Environmental Protection Agency* testing methods 3052, 6010B, or 6010C.

MICHIGAN
DEPARTMENT OF TRANSPORTATION

NOTICE TO BIDDERS
FOR
MULTIPLE DAVIS-BACON WAGE DECISIONS

CSD:JDM

1 of 1

APPR:MAS:11-21-14

This proposal may contain multiple Davis-Bacon Wage Decisions. In order to clarify the work covered by each decision, the following explanations are offered:

General Decision MI__0001 covers all airport construction, bridge construction, highway construction, and sewer and watermain work that are incidental to highway projects. The construction type indicated on this decision is "HIGHWAY (HIGHWAY, AIRPORT & BRIDGE xxxxx and SEWER/INCID. TO HWY.)". This wage decision is the most commonly used wage decision in MDOT's federally funded projects.

In accordance with the U.S. Department of Labor's All Agency Memorandums No. 130 and No. 131, multiple wage decisions will be included in those projects in which a second category of work is substantial in relation to project cost – more than approximately 20% or \$1,000,000. Sewer and watermain work is considered to fall under the Heavy Construction work classification by the DOL, therefore when that work type is more than 20% of the engineer's estimate or \$1,000,000, the wage decision with the construction type "HEAVY CONSTRUCTION PROJECTS" will also be included in the proposal and is to be used for the sewer and watermain work in the proposal. All other work performed on the project will be covered by the "HIGHWAY (HIGHWAY, AIRPORT & BRIDGE xxxxx and SEWER/INCID. TO HWY.)" wage decision.

Also, when the landscape work is more than 20% of the project cost or \$1,000,000, the "HEAVY CONSTRUCTION PROJECTS" wage decision will be included in the proposal to cover all landscape work. All other work performed on the project will be covered by the "HIGHWAY (HIGHWAY, AIRPORT & BRIDGE xxxxx and SEWER/INCID. TO HWY.)" wage decision. If the project is a total landscape project, only the "HEAVY CONSTRUCTION PROJECTS" wage decision will be in the proposal.

Rest area building projects will include the construction type "BUILDING" wage decision when the building portion of the work is more than 20% of the project cost or \$1,000,000. The other work performed on the project will be covered by the "HIGHWAY (HIGHWAY, AIRPORT & BRIDGE xxxxx and SEWER/INCID. TO HWY.)" wage decision and/or the "HEAVY CONSTRUCTION PROJECTS" wage decision (landscape and/or sewer and watermain work) if either or both are greater than 20% or \$1,000,000.

Although there is only one wage decision for "HIGHWAY (HIGHWAY, AIRPORT & BRIDGE xxxxx and SEWER/INCID. TO HWY.)", work (MI__0001), the "HEAVY CONSTRUCTION PROJECTS" and "BUILDING" wage decisions vary from county to county.

NOTICE TO BIDDERS

BID RIGGING

To report bid rigging activities call:

1-800-424-9071

The U.S. Department of Transportation (DOT) operates the above toll-free "hotline" Monday through Friday, 8:00 a.m. to 5:00 p.m., Eastern Time. Anyone with knowledge of possible bid rigging, bidder collusion, or other fraudulent activities should use the "hotline" to report such activities.

The "hotline" is part of the DOT's continuing effort to identify and investigate highway construction contract fraud and abuse and is operated under the direction of the DOT Inspector General. All information will be treated confidentially and caller anonymity will be respected.

NOTICE TO CONTRACTORS/CONSULTANTS

Fraud and Abuse Hotline

The Michigan Department of Transportation (MDOT) has established a Fraud and Abuse Hotline for employees, contractors, consultants, and others to report suspected fraud or abuse, such as: prevailing wage non-compliance, theft, kickbacks, wrongful claims, contract fraud, use of materials that do not comply with specifications, unapproved substitution of materials, commodities, or test samples, or failure to follow contract procedures.

Anyone with knowledge of any activity involving the potential for fraud or abuse is requested to call the Hotline at (toll free) **1-866-460-6368** or **517-241-2256**.

Notice To Bidders

Use of Crushed Concrete for Dense- and Open-Graded Aggregates and
Granular Material

Pursuant to the Special Provision for Crushed Concrete Near Water, included elsewhere in the contract documents, the use of crushed concrete for dense-graded aggregate, open-graded aggregate and granular material is prohibited within 100 feet of a water course or lake.

**MIDLAND COUNTY ROAD COMMISSION
NOTICE TO BIDDER FOR UTILITY COORDINATION**

1 of 1

DATE: 3/16

The contractor shall cooperate and coordinate construction activities with the owners of utilities as stated in Section 104.08 of the Michigan Department of Transportation 2012 Standard Specifications for Construction. In addition, for the protection of underground utilities, the contractor shall follow the requirements in Section 107.12 of the MDOT 2012 Standard Specifications for Construction. Contractor delay claims, resulting from a utility, will be determined based upon Section 108.09 of the MDOT 2012 Standard Specifications for Construction.

For protection of underground utilities and in conformance with Public Act 53, the Contractor shall dial 1-800-482-7171 a minimum of three full working days, excluding Saturdays, Sundays, and holidays prior to beginning each excavation in areas where public utilities have not been previously located. Members will thus be routinely notified. This does not relieve the Contractor of the responsibility of notifying utility owners who may not be a part of the "Miss Dig" alert system.

PUBLIC UTILITIES

The owners of existing service facilities that are within grading or structure limits will move them to locations designated by the Engineer, or will remove them entirely from the highway right-of-way.

Owners of Public Utilities will not be required by the County/City to move additional poles or structures in order to facilitate the operation of construction equipment unless it is determined by the Engineer that such poles or structures constitute a hazard to the public, or are extraordinarily dangerous to the Contractor's operations.

Midland County Drain Commission

Doug Enos
220 W. Ellsworth Street
Midland, MI 48640
989-832-6772 (W)
989-832-681 (F)
denos@co.midland.mi.us

Consumers Energy (Electric)

Greg Squanda
2400 Weiss St
Saginaw, MI 48602
989-791-5353 (W)
989-791-5349 (F)
989-751-2467 (M)

Charter Communications

Gordon Brooks
1480 South Valley Center Drive
Bay City, MI 48706
989-737-5356 (W)
gordon.brooks@charter.com

AT&T

Rob Augustine
309 S. Washington
Saginaw, MI 48607
989-771-5404
ra3174@att.com

Consumers Energy (Gas)

Kyle Skrabut
2400 Weiss St
Saginaw, MI 48602
989-791-5885 (W)
989-791-5719 (F)
989-751-1284 (M)
kyle.skrabut@cmsenergy.com

MICHIGAN
DEPARTMENT OF TRANSPORTATION
SUPPLEMENTAL SPECIFICATION
FOR
ERRATA TO THE 2012 STANDARD SPECIFICATIONS

1 of 30

08-01-17

Page	Subsection	Errata
3	101.02	Modify the abbreviation reading "AIS" to read "AISI".
4	101.02	Delete the following abbreviations and the long forms MDELEG MDNRE Add the following abbreviations and the long forms MDNR Michigan Department of Natural Resources MDEQ Michigan Department of Environmental Quality MDLARA Michigan Department of Licensing and Regulatory Affairs NESC National Electrical Safety Code
27	103.02.B.2	Change the last sentence of the first paragraph to read "For decreases below 75 percent, the maximum allowable payment for work performed, including any adjustment, will not exceed an amount equal to 75 percent of the original contract quantity times the contract unit price."
34	104.05	The first sentence of this subsection should read "If the Contractor performs unauthorized work (work performed without the inspections required by the contract, extra work performed without Department approval, work performed contrary to the inspectors direction, or work performed while under suspension by the inspector), the Engineer may reject the unauthorized work."
46	104.12	Add the following to the end of the first paragraph "The use of right-of-way in wetlands and floodplains, or the crossing of water courses by construction equipment is prohibited."
53	105.09	Add the following to the end of the second paragraph "Any specifically produced material not purchased by the Department, will remain the Contractors and must be removed from the project prior to final acceptance."
56	107.02.B.2	This sentence should read "U.S.Army Corps of Engineers' Section 404, Dredge and Fill; and Section 10, Navigable Waterway."
56	107.02.B	Add the subsection reading as follows: "3. U.S. Coast Guard Section 9, Navigable Waterway." Change "MDNRE" to "MDEQ" in this subsection.

Page	Subsection	Errata		
64	107.12	Change the first sentence of the first paragraph to read: "For protection of underground utilities and in accordance with 2013 PA 174, the Contractor must notify Miss Dig at least 3 work days, excluding Saturdays, Sundays and holidays, before beginning each excavation in areas where public utilities have not been previously located."		
65	107.15.A	Change "MDNRE" to "MDEQ" in four instances in this subsection.		
66	107.15.A.3	Add the following to the end of the paragraph "Note that a burn permit from the MDNR is required for any open burning whenever the ground is not snow covered. Any individuals that allow a fire to escape will be in violation of the Natural Resources and Environmental Protection Act and will be required to reimburse the costs of suppressing the wild fire."		
67*	107.16	The third sentence should read "In State Forests, the Contractor must contact the local Unit Manager, Forest Management Division, MDNR, regarding the work to be performed within or adjacent to the forest land." Delete the last sentence of the first paragraph of this subsection.		
80	108.08.F	Delete the second paragraph in its entirety.		
80	108.08.G	Add the following new subsection: "G. The Contractor may propose and the Engineer may approve another equitable method, supported by an acceptable rationale to determine time extensions for any of the excusable delays listed in subsection 108.08.		
83	108.10.C	Change the last sentence of the first paragraph to read: "The liquidated damages may contain one or more components of damages added together."		
83	108.10.C.1	In Table 108-1 delete the last row of the table and replace it with the following: <table border="1" style="margin-left: 40px;"> <tr> <td style="width: 150px;">≥50,000,000</td> <td style="width: 150px;">4,500</td> </tr> </table>	≥50,000,000	4,500
≥50,000,000	4,500			
102	109.05.E.1	Change the second sentence of the third paragraph to read: "Provide the content specified in subsection 109.05.D.11 for the applicable items in this statement and as follows:"		
107	150.04	Change the following pay item reading "Mobilization, Max ___" to read "Mobilization, Max (dollar)" at nine locations throughout the subsection.		
112	201.03.A.3.b	Change "MDNRE" to "MDNR" in three instances in this subsection.		
150	208.01	Change "MDNRE" to "MDEQ" in this subsection.		
180	308.03.A	Change the first sentence of the second paragraph to read:		

Page	Subsection	Errata
		"Do not operate equipment required to place backfill directly on geotextile products."
185	401.03.A	Change the first sentence of the second paragraph to read: Where unstable soil conditions, or obstructions other than rock, require excavation of the trench below the elevation detailed on the plans; undercut, backfill, and compact the trench as directed by the Engineer.
188	401.03.H	Change the second sentence of the paragraph to read "Jack steel pipes in place in accordance with subsection 401.03.G".
189	401.03.N	Add the following sentence to the end of the first paragraph "Where possible, maintain the stream flow thru a temporary channel or temporary culvert." The second sentence of the second paragraph should read "Direct water from the dewatering operations through a filter bag before discharging to an existing drainage facility."
189	401.04	Change the fourth pay item from the end of the list to read as follows: "Culv, Reinf Conc Ellip, (shape) CI __, (rise) inch x (span) inch".
190	401.04	Change the fourth pay item from the end of the list to read as follows: "Steel Casing Pipe, __ inch, Tr Det __."
195	402.03.C	Change the third sentence of the first paragraph to read as follows: "Wrap pipe joints, with a diameter greater than 24 inches, using geotextile blanket."
200	402.04	Change the third pay item from the top of the list to read as follows: "Sewer, CI __, __ inch, Jacked in Place"
200	402.04.A	Change the last sentence of the subsection to read as follows: "The unit price for Sewer and Sewer, Reinf Conc, Ellip includes the cost of excavation, backfill, geotextile blanket and mandrel testing."
201*	402.04.H	Change the last sentence of the first paragraph to read "The Department will not make an adjustment in the pay items of Minor Traf Devices or Traf Regulator Control ."
208	403.04.D.3	Change the sentence to read: "Removing and replacing pavement adjacent to the adjusted cover per Standard Plan R-37 Series."
218	406.03.A.2	Change the first sentence of the first paragraph to read: "Design precast box culverts less than 10 feet in span length measured along the centerline of the roadway in accordance with current AASHTO LRFD Bridge Design Specifications and ASTM C 1577." Add the following sentence to the end of the first paragraph:

Page	Subsection	Errata
		“Design precast box culverts greater than or equal to 10 feet in span length measured along the centerline of the roadway for HL-93 Modified live load.”
219	406.03.B	Change the first sentence of the first paragraph to read: “Submit shop drawings for culverts greater than or equal to 10 feet in span length measured along the centerline of the roadway to the Engineer, for review and approval in accordance with subsection 104.02.”
219	406.03.C.1	Change the second sentence of the first paragraph to read: “Before manufacture, perform load ratings on precast three-sided, arch or box culverts greater than or equal to 10 feet in span length measured along the centerline of the roadway, in accordance with the AASHTO Manual of Bridge Evaluation, Section 6, Part A, the Michigan Bridge Analysis Guide current at the time load rating is performed, and the Michigan Structure Inventory and Appraisal Guide.”
223	406.03.G	Add the following after the first sentence of the second paragraph: “Where possible, maintain the stream flow thru the existing channel, temporary channel, or temporary culvert.”
224	406.03.G	Replace the fifth paragraph of this subsection with the following: “The Contractor may use cast-in-place wing walls, headwalls, and aprons, as alternatives to precast wing walls, headwalls, and aprons. Attach cast-in-place wing walls or headwalls as shown on the shop drawings.”
225	406.03.G.2	Change the third sentence of the first paragraph to read: “Before placing the open-graded aggregate 34R, compact the coarse aggregate 6A using at least three passes of a vibrating plate compactor.”
226	406.03.G.2	Change the first sentence of the second paragraph of this subsection to read: "Fill the space between the box culvert joints during placement of box sections with closed-cell rubber extrusion type gaskets in accordance with ASTM C 990."
226	406.04.A.9	Change the sentence to read: “Providing plan modifications including design, additional plan quantities and pay items to accommodate any changes to the precast units as shown on the plans.”
226*	406.04.A	Add the following paragraph after the last paragraph of the subsection: “The substructure design is specific to the three-sided or arch culvert detailed on the plans. The Contractor must use approved MDOT service vendors qualified in Hydraulics, Geotechnical Engineering Services, and Short and Medium Span Bridges to perform the required design and

Page	Subsection	Errata
		plan modifications, as directed by the Engineer, if the Contractor selects a culvert shape different than shown on the plans."
227	406.04.B	<p>Add the following new item in the list of items in this subsection:</p> <p>2. Headwalls, wingwalls, aprons, and curtain walls, precast or cast-in-place;</p> <p>Renumber the exist items 2 through 4 in this list to read 3 through 5.</p> <p>Delete existing item numbered 5 and replace with the following:</p> <p>6. Inserts for bars and connection hardware; and</p> <p>Renumber the existing item 6 in this list to read 7.</p>
227	406.04.B	<p>Delete the first and second paragraphs following the list of items in this subsection and replace with the following:</p> <p>"The Department will pay separately for cast-in-place concrete, other than for culvert segments, wing walls, and headwalls; excavation; protective coating; providing and placing backfill material; by plan quantity in accordance with subsection 109.01.A."</p>
239	501.03.C.6	The first sentence of this subsection should read "Except as specified in subsection 501.03.C.4, removing HMA surface applies to removing HMA overlying a material designated for removal or that is required to remain in place."
247	501.03.O	Change footnote e in Table 501-5 to read: "Flushing severe enough to significantly affect surface friction (Friction Number <35)."
249	501.04.H	<p>The first sentence of this subsection should read "The Engineer will measure, and the Department will pay for removing HMA surface, no greater than 12 inches thick, overlying a material designated for removal or that is required to remain in place, as HMA Surface, Rem."</p> <p>The second paragraph of this subsection should read "The Engineer will measure, and the Department will pay for removing HMA surface, greater than 12 inches thick, overlying a material designated for removal or that is required to remain in place, as Pavt, Rem in accordance with subsection 204.04."</p>
257	503.03.E	Delete this subsection in its entirety.
265	504.03.E.3	Delete this subsection in its entirety.
269	504.04.A	This subsection should read "The unit prices for Micro-Surface , regardless of the type required, include cleaning existing pavement; applying a bond coat; temporary pavement markings; stationing; corrective action; and traffic control to complete corrective action."

Page	Subsection	Errata
299	601.04	In table 601-2 delete the row for Grade P-NC concrete in its entirety.
300	601.04	In table 601-2, the first sentence of footnote b. should read: "Use coarse aggregate 6A, 6AA or 6AAA for Grades P1, P2 and M." In table 601-2, footnote c. should read: "The mix design basis for bulk volume (dry, loose) of course aggregate per unit volume of concrete is 72% for Grade P1; 74% for Grade P2."
308	602.03.F	Note c. in Table 602-1 should read "Refer to Section D6 of the Materials Quality Assurance Procedures Manual for inspection procedure."
320	602.04.C.3	The last paragraph in this subsection should read "If the Engineer approves a substitution of a higher concrete grade for a lesser grade (e.g., P1 for P2), the Department will pay for the higher grade of concrete using the original bid and pay items of the lesser grade."
327	603.02	Change the second material in the list to read: "Concrete, Grade P-NC.....603" Change the third material in the list to read: "Base Course Aggregate, 4G, 21AA, 22A.....902"
334	603.03.B.10	Change the last sentence of the second paragraph to read "Apply the required curing compound in two coats, at a rate of at least 1 gallon per 25 square yards for each coat."
342	603.04.G.3	Change "D1" to "W" in two instances in this subsection.
351	701.04	Replace Tables 701-1A and 701-1B with the Table 701-1 below.
362	704.03.C	Change the last sentence in the first paragraph of this subsection to read: "The Engineer will consider approval after receiving applicable MDEQ permits for the alternate method."
372	705.03.C.1	Add the following sentence after the first paragraph of this subsection: "Do not drive piles within a radius of 25 feet of newly placed concrete until the concrete attains at least 75 percent of its specified minimum strength."
374	705.03.C.2.c	Change the last sentence of the second paragraph to read "Drive test piles to the minimum pile length or practical refusal, whichever is greater".
379	705.04	Change the fifth item down the list to read: "Pile, Galv (Structure No.)"
380	705.04	Change the last item in the list to read: "Pile Driving Equipment, Furn (Structure No.)"

Page	Subsection	Errata
383	706.02	The fourth paragraph following the list of materials should read "Provide AASHTO M 270, Grade 36 steel, meeting the requirements of ASTM A 786, galvanized in accordance with section 707, for expansion joint cover plates. Provide plates at least 3/8 inch thick. Use plates with a slip resistance equal to or greater than those meeting the requirements of ASTM A 786 and must be approved by the Engineer. Provide ASTM F 593 (Type 304) stainless steel, 3/4-inch or 1/2-inch diameter, flathead countersunk screws with 3/4-inch or 1/2-inch diameter inserts for use in expansion joint cover plates."
389	706.03.D.4.b	Change the first sentence of the fourth paragraph to read "Design forms, form supports, and attachments to carry dead loads, and resultant horizontal loads due to forming of cantilever overhangs."
390	706.03.E.4	Change the fourth sentence of the first paragraph to read: "Use wire ties to secure all bar intersections for the top mat. Use wire ties to secure all bar intersections for other mats where the product of the length and width of bar intersection spacing exceeds 120 square inches."
391	706.03.E.8	Change the first sentence of the second paragraph of this subsection to read: "Patch sawed or sheared ends and visible defects in accordance with ASTM A 775."
392	706.03.E.8	Change the last sentence of the third paragraph of this subsection to read: "Coat mechanical splices after splice installation in accordance with ASTM A 775 for patching damaged epoxy coating."
394	706.03.H.1	Delete the last paragraph on page 394 and replace it with the following: "Do not cast sidewalk, curb, or barrier pours until the deck concrete attains at least the minimum specified 7-day flexural or compressive strength, and after completion of the 7-day continuous wet cure. The forming of succeeding portions may occur, provided the wet cure is maintained."
406*	706.03.N.1.b	Add the following to the end of the last paragraph of the subsection: "Do not discontinue wet cure nor cast succeeding portions onto the bridge deck prior to completion of the 7-day two-phase continuous wet cure. Ensure excess or ponding cure water is removed prior to casting of succeeding structure portions."
416	707.03.C.1	Change the title of the subsection from "Shop Plans to read "Shop Drawings". Change the second sentence of this subsection to read: "Do not use design drawings in lieu of shop drawings."

Page	Subsection	Errata
426	707.03.C.17	Change the second sentence in the first paragraph of this subsection to read: "Tap oversized galvanized nuts in accordance with ASTM A 563 or AASHTO M 292 and meet Supplementary Requirement S1 of ASTM A 563 or AASHTO M 292."
430	707.03.D.7.b	Delete the first sentence of the last paragraph of this subsection.
430*	707.03.D.7.b	Change the title of the Table 707-4 to read: "Minimum Bolt Tension for ASTM F 3125 Grade A 325"
430	707.03.D.7.b	Change "104,000" to "103,000" in the last row under the column titled Minimum Bolt Tension.
431	707.03.D.7.c	Add the following sentence to the end of the first paragraph of this subsection: "If using impact wrenches, provide wrenches sufficient to tighten each bolt in approximately 10 seconds."
431*	707.03.D.7.c	Change the first sentence of the second paragraph to read: "Do not reuse ASTM F 3125 Grade A 325 bolts and nuts.."
434	707.04.A	Change the first sentence of the first paragraph of this subsection to read: "The Engineer will measure structural steel by the calculated weight of metal in the finished structure, excluding filler metal in welding, as shown on the shop drawings or working drawings."
438	708.03.A.2	Change the title of the subsection from "Shop Plans to read "Shop Drawings". Change the first sentence to read: "Submit shop drawings in accordance with subsection 104.02." Change the fourth sentence to read: "Do not start production until the Engineer approves the shop drawings."
441*	708.03.A.11	Change the last sentence of the first paragraph to read "Cure concrete at temperatures from 70 °F to 150 °F until concrete attains the release strength shown on the shop drawings".
441	708.03.A.11	Change the fourth sentence of the fourth paragraph to read "Do not exceed a maximum concrete temperature of 150 °F during the curing cycle."
458	711.03.A	Change the first sentence in the first paragraph to read: "Shop drawings for structural steel and pipe railings are not required."
460	711.04.A	Change the second sentence of the first paragraph to read:

Page	Subsection	Errata
		"The unit price for Bridge Barrier Railing includes the cost of placing steel reinforcement, providing and placing concrete, constructing joints, and forming, finishing, curing and protecting the concrete."
461	711.04.F	The title of this subsection should read " Reflective Marker, Permanent Barrier. "
467	712.03.C	Add the following to the end of the third paragraph of the subsection: "Notify the Engineer of any saw cuts in the top flange. Saw cuts equal to or less than 1/32 inch deep in steel beams must be repaired by grinding, to a surface roughness no greater than 125 micro-inches per inch rms, and tapering to the original surface using a 1:10 slope. Saw cuts in excess of 1/32 inch deep in steel beams require a welded repair to be submitted to the Engineer for approval. Weld in accordance with subsection 707.03.D.8 and provide adequate notice to allow the Engineer to witness the repair work. Inspect and test all saw cut repairs (including grinding repairs) using ultrasonic testing in accordance with 707.03.D.8.c at no additional cost to the Department."
471	712.03.J	Add the following to the end of the second paragraph of the subsection: "Select adhesive anchor systems from the Qualified Products List."
471	712.03.J.1	Delete the first paragraph in this subsection and replace it with the following: "Propose complete details of drilling, cleaning, and bonding systems for anchoring reinforcement and submit for the Engineer's approval before use. The minimum embedment depth must be nine times the anchor diameter for threaded rod or bolt and twelve times the anchor diameter for reinforcing bar. Propose a drilling method that does not cut or damage existing reinforcing steel. Prepare at least three proof tests per anchor diameter and type in the same orientation in which they will be installed on the existing structure, on a separate concrete block, in the presence of the Engineer. The Engineer will proof test the proposed systems. The Engineer will base approval of the anchoring system on the following criteria:"
471	712.03.J.2	Change the third sentence of the first paragraph to read: "Use a tension testing device for unconfined testing, in accordance with ASTM E 488."
473	712.03.L.2	Change the first sentence in the second paragraph of this subsection to read: "If using epoxy coated steel reinforcement, epoxy coat mechanical reinforcement splices in accordance with ASTM A 775."
473	712.03.L.3	Delete the existing first sentence in the first paragraph.
473	712.03.L.3	Change the third sentence of the first paragraph to read "Provide two test splices on the largest bar size."
473*	712.03.L.3	Change the sentence beginning "Demonstrate to the.... to read:

Page	Subsection	Errata
		"Demonstrate to the Engineer that splices have a tensile strength of 125 percent of the bar yield strength and high strength splices have a tensile strength of 150 percent of the bar yield strength."
488	713.02	Add the following as subsection 713.02.C: "C. Structural Steel for Retrofitting and Welded Repairs. Structural steel material used for retrofitting and welded repairs of primary members as defined in subsection 707.01.B must meet longitudinal Charpy V-Notch impact test requirements."
501	715.02	Add the following material reference above the two existing items: "Sealant for Perimeter of Beam Plates713"
508	715.03.D.1	Add the following sentence after the second paragraph of the subsection: "Apply sealant for perimeter of beam plates in accordance with subsection 713.03.F."
515	716.03.A	Delete the second paragraph of this subsection in its entirety. Change the last sentence of the last paragraph of this subsection to read: "Provide a primer dry film thickness for the top flange between 4 mils and 10 mils."
519	716.04	Change the second sentence of the first paragraph of this subsection to read: "The unit price for Field Repair of Damaged Coating (Structure No.) includes the costs of making field repairs to the shop applied coating system; prime coat surfaces and exposed surfaces of bolts, nuts, and washers; and repairing stenciling."
521	717.04.B	This subsection should read "The unit price for Drain Casting Assembly includes the cost of providing and installing the downspout and, if necessary, the lower bracket to the drain casting."
522	718.02	Change the section number "906" in the third material in the list to read "919."
533	718.04	Delete the following pay item from the list: Temp CasingFoot
533	718.04.B.2	Delete this subsection in its entirety.
533	718.04.B.3	Renumber this subsection as follows: "2. Permanent Casing. "
540	802.04	Change "Non reinf" in the last pay item of the list with "Nonreinf".
545*	803.04.E	Change the second sentence of the second paragraph to read:

Page	Subsection	Errata
		"The unit price for Railing for Steps includes the cost of providing, fabricating, installing, and grouting the railing."
560	807.04	Delete the following pay item from the list: Guardrail Buffered EndEach
560	807.04.B	Change the fifth paragraph of this subsection to read: "The Engineer will measure Guardrail Salv and Guardrail, Mult, Salv along the face of the rail (one face for multiple beams), including terminals and end shoes."
567	808.04.C	Change the first paragraph of this subsection to read: "The Department will not pay separately for protective fence required in accordance with subsection 104.07."
569	809.04.A	Change the first sentence to read: "The unit price for Field Office, CI ___ includes the cost of setup, providing access, grading, maintaining, plowing snow, and utility hook-up charges."
570	809.04.B	Delete the existing second and third sentences in the first paragraph and replace them with the following: "The unit price for Field Office, Utility Fees includes the cost of monthly usage fees for electricity, gas, telephone service and charges, fuel for the stove, monthly water and sanitary service."
570	809.04.B	Change the existing fourth sentence in the first paragraph to read: "The Department will reimburse the Contractor for monthly usage fees for electricity, gas, telephone, water and sanitary charges incurred by the Department."
575	810.03.K	Change the subsection to read "K. Drilled Piles for Cantilever and Truss Foundations. Construct drilled piles for cantilever and truss foundations in accordance with section 718."
578	810.03.N.2	Add the following sentence after the first sentence of the second paragraph on this page: "Mark each nut and bolt to reference the required rotation."
584	810.04	Delete the last pay item in the list: Truss Fdn Anchor Bolts, Replace.....Each
585	810.04.B.1	Change the second paragraph to read: "The unit prices for Fdn, Truss Sign Structure Type __, __ inch Dia, Cased and Fdn, Cantilever Sign Structure Type __, __ inch Dia, Cased include the cost of concrete, slurry, steel reinforcement, permanent casings, anchor bolts, excavation, and disposal of excavated material."

Page	Subsection	Errata
585	810.04.B.2	Change the second sentence of the first paragraph to read: "The unit prices for Fdn, Truss Sign Structure Type __, __ inch Dia, Uncased and Fdn, Cantilever Sign Structure Type __, __ inch Dia, Uncased include the cost of concrete, slurry, steel reinforcement, temporary casings, anchor bolts, excavation, and disposal of excavated material."
596	811.03.G	Delete this subsection in its entirety.
597*	811.03.H	Rename this subsection as follows: "G. Raised Pavement Marker (RPM) Removal."
597*	811.04	Change "Crosshatching" in the last pay item of the list on this page to "Cross Hatching".
598*	811.04	Delete the following pay items from the list: Pavt Mrkg, (material), 4 inch, SRSM, (color).....Foot Pavt Mrkg, (material), 4 inch, SRSM, 2 nd Application, (color).....Foot Add the following pay items to the list: "Pavt Mrkg, Polyurea, (legend).....Each Pavt Mrkg, Polyurea, (symbol).....Each" Change the sixth item down the list to read: "Pavt Mrkg, Polyurea, __ inch, Cross Hatching, (color)" Change the eleventh item down the list to read: "Rem Curing Compound, for Longit Mrkg, __ inch.....Foot"
599	811.04.B	Delete this subsection in its entirety.
599	811.04	Rename the following subsections as follows: "B. Call Back. C. Pavement Marking Removal. D. Material Deficiency."
602	812.03.D	Change the first sentence to read "Provide and maintain traffic control devices meeting the requirements in the ATSSA Quality Guidelines for Work Zone Traffic Control Devices and Features."
603	812.03.D.1	The last sentence on this page should read "Lay the sign behind the guardrail, with the uprights pointing downstream from the traffic, and place the support stands and ballasts close to the guardrail."
604	812.03.D.2	The first sentence of the fourth paragraph should read "Do not use burlap or similar material to cover Department or Local Government owned signs."
604	812.03.D.5	The fifth sentence of the first paragraph should read "Do not mix drums and cones within a traffic channeling sequence."

Page	Subsection	Errata
605	812.03.D.6.b	Change the first sentence of the first paragraph to read: "The Department will allow the nighttime use of 42-inch channelizing devices, in the tangent area only, on CPM and pavement marking of any duration where the use of plastic drums restricts proposed lane widths to less than 11 feet, including shy distance."
605	812.03.D.7	Add the following sentence after the first sentence of the first paragraph: "Place a shoulder closure taper in advance of the lighted arrows placed on the shoulders."
607	812.03.D.9	Delete the second paragraph of this subsection and replace with the following: "Link sections together to fully engage the connection between sections. Maintain the barrier with end-attachments engaged and within 2 inches of the alignment shown on the plans."
608	812.03.D.10.b	Delete the second sentence of the second paragraph of this subsection beginning with "Install sand module attenuators..."
608	812.03.D.10.b	Add the following sentence after the second paragraph of this subsection: "Install impact attenuation devices as shown on the plans, as directed by the Engineer, or both."
609	812.03.D.10.e	Delete the second paragraph of this subsection.
613*	812.03.D.14.a.iii	Change the sentence in this subsection to read "Place a terminal end shoe, in accordance with Standard Plan R-66-Series, and of appropriate type based on existing guardrail, on both blunt guardrail ends."
615	812.03.F	The second sentence of the second paragraph of this subsection should read: "The Contractor may use a Type R temporary pavement marking cover, per subsection 812.03.D.12 when authorized by the Engineer."
616	812.03.F.2	The last sentence of the first paragraph should read: "If the removal equipment cannot collect all removal debris, operate a self-propelled sweeper capable of continuously vacuuming up the removal debris immediately behind the removal equipment."
617	812.03.G.3	The first sentence of the second paragraph should read: "Sweep the shoulder and remove debris prior to placing traffic on the shoulder and throughout the time the shoulder is used to maintain traffic."
617	812.03.G.4.a	Delete "48 inch by 48 inch" from the first sentence of this subsection.
618*	812.03.G.7	The first sentence of the first paragraph should read: "Clean barrier reflectors, plastic drums, 42 inch channelizing devices, tubular markers, signs, barricades, and attached lights in operation on the project to ensure they meet required luminosity."

Page	Subsection	Errata
619	812.03.G.8	The second sentence of the third paragraph from the end of the subsection should read: "Illuminate traffic regulator stations at night per subsection 812.03.H."
621	812.03.I.6	Delete "48 inch by 48 inch" from the second sentence of this subsection.
622*	812.03.J	The second paragraph should read "Apply one 2-inch wide horizontal stripe of red and white conspicuity tape along at least 50 percent of each side of, and across the full width of the rear of the vehicle or equipment."
622	812.04	Change the second item down the list to read: "Traf Regulator Control" Change the sixth item down the list to read: "Sign Cover, Type I"
626	812.04.I	Change the reference "812.04.E" in the first sentence to "812.04.D".
628	812.04.M.4	Add the following as the first sentence of this subsection: "The Engineer will not measure a temporary barrier ending move as Conc Barrier Ending, Temp, Relocated if it involves work defined in subsection 812.04.M.3."
629	812.04.N.1	Change the reference "811.04.D" in the second paragraph of this subsection to read "811.04.C".
630	812.04.S	Change the first sentence to read: "The Department will not make additional payments for traffic regulating, signing, arrow boards, and lighting systems for traffic regulator stations operated at night due to a temporary PTS system failure."
634	813.03.C.3	Change the reference "903.07.A" in the paragraph of this subsection to read "907.07.B".
646	815.04	Change the first, third and fourth pay items in the list to read: "Site Preparation, Max (dollar) Lump Sum Watering and Cultivating, First Season, Min (dollar)..... Lump Sum Watering and Cultivating, Second Season, Min (dollar) Lump Sum"
646	815.04.C.1	Change the following pay item reading: "Watering and Cultivating, First Season, Min. (dollar)" to read "Watering and Cultivating, First Season, Min (dollar)" at two locations throughout the subsection.
646	815.04.C.1.b	Delete this subsection in its entirety.
646	815.04.C.1.c	Rename this subsection to read: "b. Removal and disposal of unacceptable plants."
646	815.04.C.2	Change the following pay item reading: "Watering and Cultivating, Second Season, Min. (dollar)" to read "Watering and Cultivating,

Page	Subsection	Errata
		Second Season, Min (dollar)" at three locations throughout the subsection.
647	815.04.C.2	Change the last paragraph of this subsection to read: "For each unacceptable plant identified, the Engineer will calculate a 50 percent reduction in the unit price for the relevant (Botanical Name) pay item, and will process a negative assessment for each unacceptable plant for that amount."
650	816.03.B	Delete the first paragraph of this subsection and replace with the following: "Conduct soil tests when called for in the contract or when directed by the Engineer. Provide soils tests results to the Engineer when testing is required. Provide and place fertilizer as indicated below and as indicated in the soils tests, if required."
650	816.03.B.1	Change the sentence to read: "For Class A fertilizer, evenly apply 176 pounds of chemical fertilizer nutrient per acre on a prepared seed bed."
650	816.03.B.2	Change the sentence to read: "For Class B fertilizer, evenly apply 120 pounds of chemical fertilizer nutrient per acre on a prepared seed bed."
650*	816.03.B.3	Change the sentence to read: "For Class C fertilizer, evenly apply 80 pounds of chemical fertilizer nutrient per acre on established turf."
663*	819.01	Delete the first paragraph in the subsection and replace it with the following: "This work consists of providing operating electrical and lighting units; removing, salvaging, or disposing of existing electrical and lighting components; excavating, backfilling, restoring the site in accordance with section 816; and disposing of waste excavated materials. Complete this work in accordance with this section, section 820, and the contract and to the requirements of the NEC, the National Electrical Safety Code, and the MDLARA for those items not identified in the contract." Change the third sentence of the second paragraph in this subsection to read: "Contact the MDLARA for electrical service inspection and pay the applicable fees."
671	819.03.F.1	Change the paragraph to read: "Install light standard foundations as shown on the plans and the standard plans, as applicable."
673	819.03.G.4.b	Change the last sentence of the first paragraph to read: "Tighten the anchor bolts to a snug tight condition as described in the third paragraph of subsection 810.03.N.2 ensuring the lock washer is completely compressed."

Page	Subsection	Errata
673	819.03.G.4.b	Delete the first two sentences of the second paragraph and replace with the following: "Tighten bolts connecting the pole to the frangible base to a snug tight condition. Snug tight is the tightness attained by a few impacts of an impact wrench, or the full effort of a person using an ordinary spud wrench. The lock washers must be fully compressed."
678	819.04	Change the ninth pay item in the list to read: "DB Cable, 600V, 1/C# (size)..... Foot"
678*	819.04	Delete the last item in the list on this page reading: "DB Cable, in Conduit, 600 Volt, (number) 1/C# (size) Foot"
679	819.04	Change the first pay item in the list to read: "DB Cable, in Conduit, 600V, 1/C# (size)..... Foot"
679	819.04	Change the sixth pay item in the list to read: "Cable, P.J., 600V, 1, (size) Foot"
680	819.04	Change the first paragraph to read: "Unless otherwise required, the unit prices for the pay items listed in this subsection include the cost of excavation, granular material, backfill, and disposal of waste excavated material. If the contract does not include pay items for restoring the site in kind in accordance with section 816, the Department will consider the cost of restoration included in the pay items listed in this subsection."
680	819.04.A	Add the following paragraph after the first paragraph of the subsection. "The unit prices for Conduit, Rem include the cost of removing the type, number, and size of conduit shown on the plans." Change the third paragraph of the subsection to read: "The unit prices for Conduit, (type), __ inch and Conduit, DB, (number), __ inch include the cost of installing the type, number, and size of conduit shown on the plans, and installing marking tape."
681	819.04.B	Change the last paragraph of the subsection to read: "The unit price for DB Cable, in Conduit, Rem includes the cost of removing all cables from the existing conduit measured per lineal foot of conduit."
681	819.04.C	Change the first paragraph of the subsection to read: "The unit prices for Cable, Rem and Cable, (type), Rem include the cost of dead ending, circuit cutting, installing guying, work required to leave circuits operable, and disposing of the removed cables, wire, hardware, and other appurtenances."
681	819.04.D	Change the first paragraph of the subsection to read: "The unit price for Cable, Pole, (type), Disman includes the cost of dismantling and off-site disposal of the following:"

Page	Subsection	Errata
685	820.01.D	Change the sentence to read: "Excavate, backfill, restore the site in kind in accordance with section 816, and dispose of excess or unsuitable material;"
688	820.03.C	Change the seventh paragraph of this subsection to read: "Tighten top anchor bolt nuts, snug, in accordance with the first four paragraphs of subsection 810.03.N.2, except beeswax will not be required."
696	820.04	Add the following pay items to the list: "Pedestal, Pushbutton, Alum.....Each Pedestal, Pushbutton, Rem.....Each"
697	820.04.A.2	Change the sentence to read: "If the contract does not include pay items for restoring the site in kind in accordance with section 816, the Department will consider the cost of restoration included in the pay items listed in this subsection."
698	820.04.B	Delete the second paragraph of this subsection found on this page.
698	820.04.C	Change " Fdns " to read " Fdn " in four instances in this subsection.
701	820.04.J.3	Change the sentence to read: "Installing wires in the saw slots and to the handholes;"
701.	820.04.J	Add the following as a new subsection: "7. A 3/4 inch minimum flexible conduit (non-metallic and rated for underground use) from the pavement to the handhole."
706	821.01.B	Change the website address listed after the second paragraph on this page to read: <u>"http://www.ngs.noaa.gov/heightmod/GuidelinesPublications.shtml"</u>
711	822.03.B	Change the second paragraph to read: "If corrugations are required on concrete shoulders and the method of installation is not shown on the plans or directed by the Engineer, construct corrugations by grinding, or cutting."
718	823.03.U	Change "MDNRE" to "MDEQ" in four instances in this subsection.
720	823.04	Change the pay item seventh from the bottom of the list to read: "Water Shutoff, Adj, Temp, Case ___"
730	824.03.Q	Change the third sentence of the fourth paragraph to read: "Ensure placement of monumentation in accordance with section 821."
730	824.03.Q	Change the first sentence of the last paragraph to read: "The Department will not pay for work dependent on lost or destroyed stakes until the Contractor replaces the stakes."

Page	Subsection	Errata
732	824.04	Change the first sentence of the first paragraph following the list of pay items to read: "If the Engineer determines the Contractor will perform staking as extra work, the Department will pay for staking in accordance with section 103."
733	824.04	Change the left column header in Table 824-2 to read: "Percent of Original Contract Amount Earned"
739	902.02	Change the last aggregate testing description to read: "Determining Specific Gravity and Absorption of Fine Aggregates.....MTM 321"
742	902.03.C.1.a	Change the sentence to read: "Coarse aggregate includes all aggregate particles greater than or retained on the 3/4-inch sieve."
742	902.03.C.2.a	Change the sentence to read: "Intermediate aggregate includes all aggregate particles passing the 3/4-inch sieve through those retained on the No. 4 sieve."
742	902.03.C.2.b.iii	Change the sentence to read as follows: "Maximum Loss by Washing per MTM 108 of 3.0 percent".
744	902.07	Delete the fourth paragraph of the subsection and replace it with the following: "The Engineer will only allow the use of granular material produced from crushed portland cement concrete for embankment and as trench backfill for non-metallic culvert and sewer pipes without associated underdrains. However, granular material produced from crushed portland cement concrete is not permitted as swamp backfill, nor within the top 3 feet below subgrade regardless of the application."
746*	902.11	Change the Item of Work by Section Number column in Table 902-1 for the 6AA row to read: "406, 601, 602, 706, 708, 806". Change the Item of Work by Section Number column in Table 902-1 for the 6A row to read: "206, 401, 402, 406, 601, 602, 603, 706, 806". Change the Item of Work by Section Number column in Table 902-1 for the 34R row to read: "401, 404, 406".
751*	902.11	Replace Table 902-6 with the Table 902-6 below.
751	Table 902-7	Under the Material column in the fourth row change the "FA2" to read "2FA".
751	Table 902-7	Under the Material column in the fifth row change the "FA3" to read "3FA".

Page	Subsection	Errata
752	Table 902-8	Under the Material column in the fourth row change the "FA2" to read "2FA".
752	Table 902-8	Under the Material column in the fifth row change the "FA3" to read "3FA".
761	Table 904-2	Delete the footnote f and any other reference to footnote f from the table.
767	905.03	Change the first sentence of the first paragraph to read: "Deformed bars, must meet the requirements of ASTM A 706, ASTM A 615, or ASTM A 996 (Type R or Type A only) for Grade 60 steel bars, unless otherwise required".
767*	905.03	Change the first sentence of the second paragraph to read: "Unless otherwise specified, spiral reinforcement must meet the requirements of plain or deformed Grade 40 steel bars of ASTM A 615, ASTM A 996 (Type A), or the requirements of cold-drawn wire of ASTM A 1064".
767	905.03	Change the first sentence of the third paragraph to read: "Bar reinforcement for prestressed concrete beams must meet the requirements of ASTM A 996 (Type R) for Grade 60 steel bars, except the Engineer will allow bar reinforcement that meets the requirements of ASTM A 615 or ASTM A 996 (Type A) for Grade 40 steel bars for stirrups in prestressed concrete beams".
768	905.03.C	Change the first sentence in the subsection to read: "Epoxy coated steel reinforcement, if required, must be coated in accordance with ASTM A 775, with the following exceptions and additions."
768	905.03.C.3	Change the first sentence of this subsection to read: "Include written certification that the coated reinforcing bars were cleaned, coated, and tested in accordance with ASTM A 775 with the coating applicator."
768	905.05	Change the first sentence of the first paragraph to read: "Deformed steel bars must meet the requirements of ASTM A 706 or the requirements for Grade 40, Grade 50, or Grade 60 of ASTM A 615 or ASTM A 996 (Type R or Type A only)".
768	905.06	Delete this subsection in its entirety and replace it with the following: "Deformed wire fabric for prestressed concrete and fabric for concrete pavement reinforcement must meet the requirements of ASTM A 1064 and fabricated as required."
772*	906.07	Change the first paragraph to read: "High-strength bolt fasteners for structural joints must meet the requirements of ASTM F 3125 Grade A 325 Type 1 bolts. High-strength nuts for structural joints must meet the requirements of ASTM A 563

Page	Subsection	Errata
		Grade DH or AASHTO M 292 Grade 2H. High-strength washers for structural joints must meet the requirements of ASTM F 436 Type 1 for circular, beveled, clipped circular, and clipped beveled washers."
		Change the second sentence of the second paragraph of this subsection to read: "Galvanized nuts must be tapped oversize in accordance with ASTM A 563 and meet Supplementary Requirements S1, Lubricant and Rotational Capacity Test for Coated Nuts and S2, Lubricant Dye."
777*	907.03.D.2.a	Change the first sentence of the second paragraph to read: "Angle sections must be nominal 2½ inch by 2½ inch by ¼ inch."
777*	907.03.D.2.b	Change the first sentence of the first paragraph to read: "Angle section braces must be nominal 1¾ inch by 1¾ inch by ¼ inch or nominal 2 inch by 2 inch ³ / ₁₆ inch."
782	908.04	Change the first sentence of the first paragraph of this subsection to read: "Steel castings for steel construction must meet the requirements of ASTM A 148 for Grade 60/90 carbon steel castings, as shown on the plans, unless the Engineer approves an alternate in writing."
783*	908.09.A	Change the title of this subsection and the first sentence to read "A. Base Plates, Angle, and Non-Tubular Post Elements. Galvanized base plates, angle, rail splice elements, and non-tubular post elements must meet the requirements of ASTM A 36 and ASTM A 123".
783*	908.09.B	Change the title of this subsection and the first sentence to read "B. Rail Elements and Tubular Post Elements. Rail elements and tubular post elements must meet the requirements of ASTM A 500, for Grade B and subsection 908.09.B and be galvanized in accordance with ASTM A 123".
784*	908.09.C	Change this subsection to read: "C. Hardware. Railing anchor studs must meet the requirements of ASTM A 449 Type 1. Heavy hex nuts must meet the requirements of ASTM A 563. Bolts, used as rail fasteners, must meet the requirements of ASTM F 3125 Grade A 325, Type 1. Where called for, round head bolts must meet the requirements of ASTM A 449 Type 1. The material for the railing hand hole screws must meet the requirements of ASTM A 276, Type 304. All nuts must meet the requirements of ASTM A 563 Grade DH or AASHTO M 292 Grade 2H. All flat washers must meet the requirements of ASTM F 436. Lock washers must be steel, regular, helical spring washers meeting the requirements of ANSI B18.21.1 - 1972. Bolts, nuts, washers and other hardware must be hot-dip galvanized in accordance with AASHTO M 232. Galvanized nuts must be tapped oversize in accordance with ASTM A 563, and meet

Page	Subsection	Errata
		Supplementary Requirements S1, Lubricant and Rotational Capacity Test for Coated Nuts, and S2, Lubricant Dye."
784	908.11.A	Change the first sentence of the first paragraph to read: "Steel beam sections, backup elements, terminal end shoes, and special end shoes must meet the requirements of AASHTO M 180, for Class A guardrail."
785*	908.11.B	Change the second paragraph to read: "Bolts, nuts, and round washers for guardrail, other than at bridge barrier railings, must meet the requirements of ASTM A 307 (Grade A), ASTM A 563 (Grade A with Supplementary Requirements S1 of ASTM A 563), and ASTM F 436, respectively." Change the third paragraph to read: "Washers, other than round washers, for guardrail must meet the requirements for circular washers in ASTM F 436 except that the dimensions must be as shown on the plans." Change the fifth paragraph to read: "Bolts, nuts, and washers for connections at bridge barrier railings must conform to ASTM F 3125 Grade A 325 Type 1 galvanized high-strength structural bolts with suitable nuts and hardened washers."
787	908.14.B	Add the following sentence to the end of the third paragraph of this subsection: "Exposed threaded ends of anchor bolts must be galvanized a minimum of 20 inches." Change the sixth paragraph in this subsection to read: "Provide washers meeting the requirements of ASTM F 436 for circular washers."
787	908.14.B	Change the second sentence of the fourth paragraph to read "After coating, the maximum limit of pitch and major diameter for bolts with a diameter no greater than 1 inch may exceed the Class 2A limit by no greater than 0.021 inch, and by no greater than 0.031 inch for bolts greater than 1 inch in diameter".
787*	908.14.C	Change the first paragraph to read "Provide either four or six high strength anchor bolts per the contract plans, meeting the mechanical requirements of ASTM F 1554, for Grade 105, with each standard. Anchor bolts for traffic signal strain poles must meet the requirements of subsection 908.14.B with the following exceptions and additions:"
789	909.03	Change the second sentence of the second paragraph to read: "As an alternative to the AASHTO M 36 requirements for metal pipe, the Contractor may use gasket material meeting the low temperature flexibility and elevated temperature flow test requirements of ASTM C

Page	Subsection	Errata
		990, excluding the requirements for softening point, flashpoint and fire point."
793	909.06	Change the first sentence of the second paragraph of this subsection to read: "Provide Corrugated Polyvinyl Chloride Pipe (CPV) and required fittings meeting the requirements of AASHTO M 304."
793*	909.05.D	Change the second sentence of the paragraph to read "Provide a continuous welded joint to create a watertight casing that is capable of withstanding handling and installation stresses. Perform field welding by the SMAW process using E7018 electrodes."
794*	909.08.A	Change the first sentence to read: "Provide bridge deck downspouts of PE pipe meeting the requirements of ASTM F 714, PE 4710, DR 26."
804	Table 909-9	In the note area at the bottom of the table change the designation of the second note from "c." to "b."
811	910.04	Add the following sentence to the end of this subsection: "Fabricate silt fence according to subsection 916.02."
814	Table 911-1	In the 4 th row of the 5 rows in the table change the Property listed as "Total Organic Content (TOC)" to read "Total Organic Carbon (TOC)".
829*	912.08.K	Replace Table 912-10 with the Table 912-10 below.
833*	913.03.B	Change the first sentence of the first paragraph to read: "Clay brick, to construct manholes, catch basins, and similar structures, must meet the requirements of ASTM C 32, for Grade MS."
837*	914.04	Add the following as subsection 914.04.C: "C. Lubricant-Adhesive for Neoprene Joint Seals. The lubricant-adhesive must be a single-component moisture-curing polyurethane and aromatic hydrocarbon solvent mixture meeting ASTM D 2835, Type I. Ship in containers plainly marked with the lot or batch number of the material and date of manufacture. Store at temperatures between 58 and 80°F. Do not exceed 12 months shelf-life prior to use."
840	914.08	Change the first sentence of the second paragraph to read: "Straight tie bars for end-of-pour joints must consist of bars of the diameter and length shown on the plans meeting the requirements of ASTM A 615, ASTM A 706, or ASTM A 996 (Type R or Type A only)".
840*	914.09.A	Change the first sentence of the first paragraph to read: "Straight tie bars for longitudinal pavement joints must consist of bars of the diameter and length shown on the plans meeting the requirements of ASTM A 615, ASTM A 706, or ASTM A 996 (Type R or Type A only)".

Page	Subsection	Errata
840	914.09.B	Change the first sentence of the first paragraph to read: "Bent tie bars for bulkhead joints must consist of bars of the diameter and length shown on the plans."
841	914.12	In the first sentence of this subsection change "AASHTO Division II" to read "AASHTO LRFD Bridge Construction Specifications".
841*	914.13	In the first sentence of this subsection change "ASTM D 1248, for Type III, Class B" to read "ASTM D 4976, Group 2, Class 4, Grade 4".
844	916.01.A	Change the first sentence to read: "Cobblestone must consist of rounded or semi-rounded rock fragments with an average dimension from 3 inches to 10 inches."
845	916.01.D.1	Change the second sentence to read: "Checkdams for ditch grades 2 percent or greater must be constructed using cobblestone or broken concrete ranging from 3 inches to 10 inches in size."
851*	917.10.B.1	Delete the paragraph and replace it with the following: "1. Class A. Provide and apply Class A chemical nutrient fertilizer either according to MSU Soil Testing Lab Recommendations for Phosphorus Applications to Turfgrass, except the maximum single application rate of nutrient will be 48 pounds per acre, when soil tests are required or as indicated in subsections 917.10.B.1.a and 917.10.B.1.b."
851	917.10.B.1	Add the MSU Soil Testing Lab Recommendations for Phosphorus Applications to Turfgrass, found below, after the first paragraph of this subsection.
853	917.15.B.1	Change the second sentence of the subsection to read: "The net must meet the requirements of subsection 917.15.D and be capable of reinforcing the blanket to prevent damage during shipping, handling, and installation."
857	918.01	Add the following two paragraphs following the first paragraph of this subsection: "Wall thickness and outside diameter dimensions must conform to ASTM D 1785 for smooth-wall schedule 40 and 80 PVC conduit material. The Department will allow no more than 3 percent deviation from the minimum wall thickness specified. Wall thickness range must be within 12 percent in accordance with ASTM D 3035 for smooth-wall coilable schedule 40 and 80 PE conduit."
858	918.01.E	Delete the first three sentences of the second paragraph shown on page 858.
863	918.06.F.1	Delete the third paragraph in this subsection in its entirety and replace it with the following:

Page	Subsection	Errata
		"Provide smooth or deformed welded wire fabric in accordance with ASTM A 1064."
864	918.07.C	Change the first sentence of the first paragraph to read: "Provide anchor bolts, nuts, and washers meeting the requirements of subsection 908.14.A and subsection 908.14.B."
864	918.07.C	Delete the second sentence of the second paragraph.
864	918.07.C	Change the third sentence to read: "Provide anchor bolts threaded 4 inches beyond the anchor bolt projection shown on the plans."
867	918.08.C	Change the last sentence of the first paragraph on this page to read: "Galvanize bolts, nuts, washers, and lock washers as specified in subsection 908.14.B."
867	918.08.C	Change the last sentence of the subsection to read: "Provide each frangible base with manufacturer access covers as shown on the plans."
867*	918.08.D	Delete this subsection in its entirety and replace with the following: "Provide galvanized anchor bolts, studs, nuts, couplings, and washers in accordance with subsection 908.14."
879	918.10.J	Change the third sentence of the second paragraph of this subsection to read: "Provide anchor bolts and associated nuts, washers, and hardware meeting the requirements of subsection 908.14."
887	919.06	Change the second paragraph to read: "Shims must be fabricated from brass shim stock or brass strip meeting the requirements of ASTM B 36, for copper alloy UNS No. C26000, half-hard rolled temper, or fabricated from galvanized sheeting meeting the requirements of ASTM A 653, for Coating Designation G 90."
887	919.07.C	Change the sentence to read: "Galvanized high-strength steel bolts, nuts, and washers for connecting arm connection flanges must meet the requirements of subsection 906.07."
903	921.03.D	Delete the last three sentences of the first paragraph of this subsection.
914	921.05.D	Change the first sentence of this subsection to read: "Provide anchor bolts meeting the requirements of subsection 908.14.C, including elongation and reduction of area requirements."
916	921.07	Change the first sentence of the first paragraph to read: "Provide LED case signs internally illuminated by LEDs and changeable message case signs internally illuminated with LED light sources."

Page	Subsection	Errata
936	922.04.B	In the first sentence of the first paragraph change the "R-52" to "R-126".
936	922.04.B	Add the following to the end of the first paragraph: "Hardware used to connect the end section to the barrier must meet the requirements of NCHRP 350 or MASH (Test Level 3 or higher)."
936	922.04.B	In the first sentence of the second paragraph delete "R-52".
936	922.04.B	Change the fourth paragraph of this subsection to read as follows: For all endings requiring impact attenuators provide a NCHRP-350 Test Level 3 or MASH Test Level 3 approved impact attenuation system, unless otherwise approved by the Engineer.
953*	Pay Item Index	Delete the following pay item reading: "DB Cable, in Conduit, 600 Volt, (number) 1/C# (size)678 819"
957	Pay Item Index	Delete the following pay item from the list: Guardrail Buffered End560 807
960	Pay Item Index	Change the following pay item to read: "Mobilization, Max (dollar)107 150"
961	Pay item Index	Delete the following pay items from the list: Pavt Mrkg, (material), 4 inch, SRSM, (color).....598.....811 Pavt Mrkg, (material), 4 inch, SRSM, 2 nd Application, (color).....598.....811
961	Pay Item Index	Change the following pay items in the list to read: Pavt Mrkg, Ovly Cold Plastic, 12 inch, Cross Hatching, (color) Pavt Mrkg, Polyurea, __ inch, Cross Hatching, (color) Add the following pay items to the list: "Pavt Mrkg, Polyurea, (legend).....598.....811 Pavt Mrkg, Polyurea, (symbol).....598.....811 Pedestal, Pushbutton, Alum.....696.....820 Pedestal, Pushbutton, Rem.....696.....820"
962	Pay Item Index	Change the following pay items in the list to read: "Pile Driving Equipment, Furn (Structure No.) Pile, Galv (Structure No.)"
963	Pay Item Index	Change the following pay item to read: "Rem Curing Compound, for Longit Mrkg, __ inch598 811"
964	Pay Item Index	Change the following pay item to read: "Sewer, CI __, __ inch, Jacked in Place200 402" "Sign Cover, Type I622 812"
965*	Pay Item Index	Change the following pay item in the list to read:

Page	Subsection	Errata		
		“Steel Casing Pipe, __ inch, Tr Det __ Site Preparation, Max (dollar)	646	815”
966	Pay Item Index	Delete the following pay item form the list; Temp Casing.....	533.....	718
967*	Pay Item Index	Delete the following pay item from the list; Truss Fdn Anchor Bolts, Replace.....	584.....	810
967	Pay Item Index	Change the following pay item in the list to read: “Traf Regulator Control”		
968*	Pay item Index	Change the following pay item in the list to read: “Water Shutoff, Adj, Temp, Case __ Watering and Cultivating, First Season, Min (dollar)..... Watering and Cultivating, Second Season, Min (dollar)	646 646	815 815”
993	General Index	Change “Shop Plans (see Plans and Working Drawings)” to read “Shop Drawings (see Plans and Working Drawings)”.		

Table 701-1 Concrete Structure Mixtures													
		Slump (inches)				Minimum Strength of Concrete (f)							
Concrete Grade (e,h)	Section Number Reference (i)	Cement Content per cyd (b,c)		Type A, D or no Admixture	Type MR, F, or G Admixtures (g)			Flexural (psi)			Compressive (psi)		
		lb	sack		Before Admixture	After Admixture (Type MR)	After Admixture (Type F or G)	7 Day	14 Day	28 Day (Class Design Strength)	7 Day	14 Day	28 Day (Class Design Strength)
D (a)	706, 711, 712	658 (d)	7.0	0 - 3	0 - 3	0 - 6	0 - 7	625	700	725	3,200	4,000	4,500
S1	705	611	6.5	3 - 5	0 - 3	3 - 6	3 - 7	600	650	700	3,000	3,500	4,000
T	705, 706	611	6.5	3 - 7	0 - 4	3 - 7	3 - 8	550	600	650	2,600	3,000	3,500
S2 (a)	401, 705, 706, 712, 713, 801, 802, 803, 810	564	6.0	0 - 3	0 - 3	0 - 6	0 - 7	550	600	650	2,600	3,000	3,500
		526 (d)	5.6										
S3	402, 403, 803, 804, 806	517	5.5	0 - 3	0 - 3	0 - 6	0 - 7	500	550	600	2,200	2,600	3,000
		489 (d)	5.2										

a. Unless otherwise required, use Coarse Aggregate 6AA or 17A for exposed structural concrete in bridges, retaining walls, and pump stations.

b. Do not place concrete mixtures containing supplemental cementitious materials unless the local average minimum temperature for the next 10 consecutive days is forecast to be above 40 °F. Adjustments to the time required for opening to construction or vehicular traffic may be necessary. Cold weather protection may be required, as described in the quality control plan. The restriction does not apply to Grade S1 concrete in foundation piling below ground level or Grade T concrete in tremie construction.

c. Type III cement is not permitted

d. Use admixture quantities specified by the Qualified Products Lists to reduce mixing water. Admixture use is required for Grade D, Grade S2, and Grade S3, concrete with a reduced cement content. Use a water-reducing retarding admixture at the required dosage for Grade D concrete to provide the setting retardation required. When the maximum air temperature is not forecast to exceed 60 °F for the day, the Contractor may use a water-reducing admixture or a water-reducing retarding admixture. Ensure Grade D concrete in concrete diaphragms contains a water-reducing admixture, or a water-reducing retarding admixture. For night casting, the Contractor may use a water-reducing admixture in lieu of water-reducing retarding admixture, provided that the concrete can be placed and finished prior to initial set.

e. The mix design basis for bulk volume (dry, loose) of coarse aggregate per unit volume of concrete is 68% for Grade S1, and 70% for Grade D, Grade S2, Grade T, and Grade S3.

f. The Contractor may use flexural strength to determine form removal. Use compressive strength for acceptance in other situations.

g. MR = Mid-range.

h. The Engineer will allow the use of an optimized aggregate gradation as specified in section 604.

i. Section Number Reference:

401	Culverts	711	Bridge Railings	803	Concrete Sidewalk, Sidewalk Ramps, and Steps
402	Storm Sewers	712	Bridge Rehabilitation-Concrete	804	Concrete Barriers and Glare Screens
403	Drainage Structures	713	Bridge Rehabilitation-Steel	806	Bicycle Paths
705	Foundation Piling	801	Concrete Driveways	810	Permanent Traffic Signs and Supports
706	Structural Concrete Construction	802	Concrete Curb, Gutter and Dividers		

An asterisk (*) indicates an entry which has been revised from an earlier version of this Supplemental Specification.

**Table 902-6
Superpave Final Aggregate Blend Physical Requirements**

Est. Traffic (million ESAL)	Mix Type	Percent Crushed Minimum Criteria		Fine Aggregate Angularity Minimum Criteria		% Sand Equivalent Minimum Criteria		Los Angeles Abrasion % Loss Maximum Criteria		% Soft Particles Maximum Criteria (b)		% Flat and Elongated Particles Maximum Criteria (c)	
		Top & Leveling Courses	Base Course	Top & Leveling Courses	Base Course	Top & Leveling Courses	Base Course	Top & Leveling Courses	Base Course	Top & Leveling Courses	Base Course	Top & Leveling Courses	Base Course
< 0.3	LVSP	55/—	—	—	—	40	40	45	45	10	10	—	—
< 0.3	E03	55/—	—	—	—	40	40	45	45	10	10	—	—
≥0.3 - <1.0	E1	65/—	—	40	—	40	40	40	45	10	10	—	—
≥1.0 - < 3	E3	75/—	50/—	40(a)	40(a)	40	40	35	40	5	5	10	10
≥3 - <10	E10	85/80	60/—	45	40	45	45	35	40	5	5	10	10
≥10 - <30	E30	95/90	80/75	45	40	45	45	35	35	3	4.5	10	10
≥30 - <100	E50	100/10 0	95/90	45	45	50	50	35	35	3	4.5	10	10

(a) For an E3 mixture type that enters the restricted zone as defined in Table 902-5, the minimum is 43. If these criteria are satisfied, acceptance criteria and associated incentive/disincentive or pay adjustment tied to this gradation restricted zone requirement included in contract, do not apply. Otherwise, final gradation blend must be outside of the restricted zone.

(b) Soft particles maximum is the sum of the shale, siltstone, ochre, coal, clay-ironstone and particles that are structurally weak or are non-durable in service.

(c) Maximum by weight with a 1 to 5 aspect ratio.

Note: "85/80" denotes that 85 percent of the coarse aggregate has one fractured face and 80 percent has at least two fractured faces.

An asterisk (*) indicates an entry which has been revised from an earlier version of this Supplemental Specification.

Table 912-10 Minimum Retention Requirements				
Preservative	Minimum Retention, (pcf)			AWPA Standard
	Guardrail Posts	Sign Posts	Blocks	
Pentachlorophenol	0.60	0.50	0.40	A6
CCA, ACZA	0.60	0.50	0.40	A11
ACQ (a)	0.60	Not Allowed	0.40	A11
CA-B (a)	0.31	Not Allowed	0.21	A11
CA-A (a)	0.31	Not Allowed	0.15	A11
Other Waterborne preservatives	AWPA Commodity Specification A, Table 3.0, Use Category 4B	Not Allowed	AWPA Commodity Specification A, Table 3.0, Use Category 4A	A11
a. Non-Metallic washers or spacers are required for timber and lumber treated with ACQ or CA placed in direct contact with aluminum. Do not use with sign posts.				

MSU Soil Testing Lab Recommendations for Phosphorus Applications to Turfgrass
3/8/2012

		Sand based rootzone establishment	Golf greens and tees est. or mature; Kentucky bluegrass or perennial ryegrass athletic fields est. or mature; sand based rootzone mature	Lawns, golf course fairways; establishment or mature	Establishment without soil test
Bray P1, Mehlich 3 Soil Test Value (ppm): pH<7.4	Olsen Soil Test Value (ppm) pH>7.4	Recommendation (lbs. P ₂ O ₅ /1000 ft. ²)	Recommendation (lbs. P ₂ O ₅ /1000 ft. ²)	Recommendation (lbs. P ₂ O ₅ /1000 ft. ²)	Recommendation (lbs. P ₂ O ₅ /1000 ft. ²)
0	0	4.4	3.4	2.5	2.5 lbs. year (Maximum single application of 1.5 lbs.)
2	1.3	4.1	3.1	2.2	
4	2.7	3.9	2.7	1.9	
6	4	3.6	2.4	1.6	
8	5.3	3.4	2.0	1.3	
10	6.7	3.1	1.7	1.0	
12	8	2.8	1.4	0.7	
14	9.3	2.6	1.0	0.4	
16	10.7	2.3	0.7	0.1	
18	12	2.1	0.3	0.0	
20	13.3	1.8	0.0		
22	14.7	1.5			
24	16	1.3			
26	17.3	1.0			
28	18.7	0.8			
30	20	0.5			
32	21.3	0.2			
34	22.7	0.0			

Web resources: www.turf.msu.edu or www.bephosphorusmart.msu.edu



MIDLAND
COUNTY ROAD COMMISSION
2334 N. MERIDIAN ROAD
SANFORD, MI 48657

Phone (989) 687-9060
Fax (989) 687-9121
www.midlandroads.com

Notice to Bidders

Russ Inman

russ@midlandroads.com

E-mail

989-687-9060

Phone number

You are notified that all inquiries must be made thru the above employee of the Midland CRC. All inquiries shall be made at least 2 days in advance before the opening of bids. Inquires must include the in the subject line the job number and Bid Inquiry

NON-COLLUSION STATEMENT

Project No. _____ Job No. _____ Fed. Project No. _____

Project No. _____ Job No. _____ Fed. Project No. _____

Project No. _____ Job No. _____ Fed. Project No. _____

Project No. _____ Job No. _____ Fed. Project No. _____

The undersigned _____
(name printed or typed)

title _____ declares under penalty of perjury of the laws of the United

States that _____
(official company name)

is/are Contractor submitting this bid, and that its agents, officers or employees have not directly or indirectly entered into any agreements, participated in any collusion, or otherwise taken any action in restraint of free competitive bidding in connection with this proposal for the above project.

authorized signer (signature)

Each bidder shall file a signed statement executed by, or on behalf of the person, farm, association, or corporation submitting the bid, certifying that such person, firm, association, or corporation has not either directly or indirectly entered into any agreement, participated in any collusion, or otherwise taken any action, in restraint of free competitive bidding in connection with the submitted bid. Failure to submit the signed statement as part of the bid will be cause for rejection of the bid.

APPENDIX A
PROHIBITION OF DISCRIMINATION IN STATE CONTRACTS

In connection with the performance of work under this contract; the contractor agrees as follows:

1. In accordance with Act. No. 453, Public Acts of 1976, the contractor hereby agrees not to discriminate against an employee or applicant for employment with respect to hire, tenure, terms, conditions, or privileges of employment, or a matter directly or indirectly related to employment, because of race, color, religion, national origin, age, sex, height, weight, or marital status. Further, in accordance with Act No. 220, Public Acts of 1976 as amended by Act No. 478, Public Acts of 1980, the contractor hereby agrees not to discriminate against an employee or applicant for employment tenure, terms, conditions, or privileges of employment, or a matter directly or indirectly related to employment, because of a disability that is unrelated to the individual's ability to perform the duties of a particular job or position. A breach of the above covenants shall be regarded as a material breach of this contract.
2. The contractor hereby agrees that any and all subcontractors to this contract, whereby a portion of the work set forth in this contract is to be performed, shall contain a covenant the same as in herein before set forth in section 1 of this Appendix.
3. The contractor will take affirmative action to insure that applicants for employment and employees are treated without regard to their race, color, religion, national origin, sex, height, weight, marital status or disability that is unrelated to the individual's ability to perform the duties of a particular job or position. Such action shall include, but not be limited to the following; employment, upgrading, demotion or transfer, recruitment advertising; layoff or termination; rates of pay or other forms of compensation; and selection for training, including apprenticeship.
4. The contractor will, in all solicitations or advertisements for employees placed by or on behalf of the contractor, state that all qualified applicants will receive consideration for employment without regard to race, color, religion, national origin, age, sex, height, marital status or disability that is unrelated to the individuals ability to perform the duties of a particular job or position.
5. The contractor or his collective bargaining representative will send to each labor union or representative of workers with which he has a collective bargaining agreement or other contract or understanding, a notice advising the said labor union or workers' representative of the contractor's commitments under this appendix.
6. The contractor will comply with relevant published rules, regulations, directives, and orders of the Michigan Civil Rights Commission which may be in effect prior to the taking of bids for any individual state project.
7. The contractor will furnish and file compliance reports within such time and upon such forms as provided by the Michigan Civil Rights Commission, said forms may also elicit information as to the practices, policies, program and employment statistics of each subcontractor as well as the contractor himself, and said contractor will permit access to his books, records, and accounts by the Michigan Civil Rights Commission, and/or its agent, for purposes of investigation to ascertain compliance with this contract and relevant with rules, regulations, and orders of the Michigan Civil Rights Commission.
8. In the event that the Civil Rights Commission finds, after a hearing held pursuant to its rules, that a contractor has not complied with the contractual obligations under this agreement, the Civil Rights Commission may, as a part of its order based upon such findings, certify said findings to the Administrative Board of the State of Michigan, which Administrative Board may order the cancellation of the contract found to have been violated, and/or declare the contractor ineligible for future contracts with the state and its political and civil subdivisions, departments, and officers, and including the governing boards of institutions of higher education, until the contractor complies with all of the persons with whom the contractor is declared ineligible to contract as a contracting party in future contracts. In any case before the Civil Rights Commission in which cancellation of an exiting contract is a possibility, the contracting agency shall be notified of such possible remedy and shall be given the option by the Civil Rights Commission to participate in such proceedings.
9. The contractor will include, or incorporate by reference, the provisions of the forgoing paragraphs (1) through (8) in every subcontract or purchase order unless exempted by rules, regulations or orders of the Michigan Civil Rights Commission, and will provide in every subcontract or purchase order that said provisions will be binding upon each subcontractor or seller.

**The Civil Rights Commission referred to as the Michigan Civil Rights Commission*

TITLE VI ASSURANCE

APPENDIX C

During the performance of this contract, the contractor, for itself, its assignees and successors in interest (hereinafter referred to as the "contractor") agrees as follows:

1. **Compliance with Regulations:** The contractor shall comply with the Regulations relative to nondiscrimination in Federally-assisted programs of the Department of Transportation, Title 49, code of Federal Regulations, Part 21, as they may be amended from time to time, (hereinafter referred to as the Regulations), which are herein incorporated by reference and made a part of this contract.
2. **Nondiscrimination:** The contractor, with regard to the work performed by it during the contract, shall not discriminate on the grounds of race, color, national origin, sex, age, or disability in the selection and retention of subcontractors, including procurements of materials and leases of equipment. The contractor shall not participate either directly or indirectly in the discrimination prohibited by section 21.5 of the Regulation, including employment practices when the contractor covers a program set forth in Appendix B of the Regulations.
3. **Solicitations for Subcontracts, Including Procurements of Materials and Equipment:** In all solicitations either by competitive bidding or negotiation made by the contractor for work to be performed under a subcontract, including procurements of materials or leases of equipment, each potential subcontractor or supplier shall be notified by the contractor of the contractor's obligations under the contract and the Regulations relative to nondiscrimination on the grounds of race, color, national origin, sex, age, or disability.
4. **Information and Reports:** The contractor shall provide all information and reports required by the Regulations, or directives issued pursuant thereto, and shall permit access to its books, records, accounts, other sources of information, and its facilities as may be determined by the State Highway department of the Federal Highway Administration to be pertinent to ascertain compliance with such Regulations or directives. Where any information required of a contractor is in the exclusive possession of another who fails or refuses to furnish this information, the contractor shall so certify to the State highway department, or the Federal Highway Administration as appropriate, and shall set forth what efforts it has made to obtain the information.
5. **Sanctions for Noncompliance:** In the event of the contractor's noncompliance with the nondiscrimination provisions of this contract, the State highway department shall impose such contract sanctions as it or the Federal Highway Administration may determine to be appropriate, including, but not limited to:
 - (a) withholding of payments to the contractor under the contract until the contractor complies, and/or
 - (b) cancellation, termination or suspension of the contract, in whole or in part.
6. **Incorporation of Provisions:** The contractor shall include the provisions of paragraphs (1) through (6) in every subcontract, including procurement of materials and leases of equipment, unless exempt by the Regulations, or directives issued pursuant thereto. The contractor shall take such action with respect to any subcontract or procurement as the State highway department or the Federal Highway Administration may direct as a means of enforcing such provisions including sanctions for non-compliance: Provided, however, that, in the event a contractor becomes involved in, or is threatened with, litigation with a subcontractor or supplier as a result of such direction, the contractor may request the State highway department to enter into such litigation to protect the interests of the State, and, in addition, the contractor may request the United States to enter into such litigation to protect the interests of the United States

GENERAL REQUIREMENTS FOR RECIPIENTS

Excerpts from USDOT Regulation 49 CFR, Part 26

A. **26.5 What Do The Terms Used In This Part Mean? *(Replaces 23.5 and 23.62)**

Insert the following portions:

Disadvantaged Business Enterprise or DBE means a for-profit small business concern—

(1) That is at least 51 percent owned by one or more individuals who are both socially and economically disadvantaged or, in the case of a corporation, in which 51 percent of the stock is owned by one or more such individuals; and

(2) Whose management and daily business operations are controlled by one or more of the socially and economically disadvantaged individuals who own it.

Small Business Concern means, with respect to firms seeking to participate as DBEs in DOT-assisted contracts, a small business concern as defined pursuant to section 3 of the Small Business Act and Small Business Administration regulations implementing it (13 CFR part 121) that also does not exceed the cap on average annual gross receipts specified in Sec. 26.65(b).

Socially and economically disadvantaged individual means any individual who is a citizen (or lawfully admitted permanent resident) of the United States and who is—

(1) Any individual who a recipient finds to be a socially and economically disadvantaged individual on a case-by-case basis.

(2) Any individual in the following groups, members of which are rebuttably presumed to be socially and economically disadvantaged:

(i) “Black Americans,” which includes persons having origins in any of the Black racial groups of Africa;

(ii) “Hispanic Americans,” which includes persons of Mexican, Puerto Rican, Cuban, Dominican, Central or South American, or other Spanish or Portuguese culture or origin, regardless of race;

(iii) “Native Americans,” which includes persons who are American Indians, Eskimos, Aleuts, or Native Hawaiians;

(iv) “Asian-Pacific Americans,” which includes persons whose origins are from Japan, China, Taiwan, Korea, Burma (Myanmar), Vietnam, Laos, Cambodia (Kampuchea), Thailand, Malaysia, Indonesia, the Philippines, Brunei, Samoa, Guam, the U.S. Trust Territories of the Pacific Islands, Macao, Fiji, Tonga, Kirbati, Juvalu, Nauru, Federated States of Micronesia, or Hong Kong;

(v) “Subcontinent Asian Americans,” which includes persons whose origins are from India, Pakistan, Bangladesh, Bhutan, the Maldives Islands, Nepal or Sri Lanka;

(vi) Women;

(vii) Any additional groups whose members are designated as socially and economically disadvantaged by the SBA, at such time as the SBA designation becomes effective.

Tribally-owned concern means any concern at least 51 percent owned by an Indian tribe as defined in this section.

You refers to a recipient, unless a statement in the text of this part or the context requires otherwise (i.e., ‘You must do XYZ’ means that recipients must do XYZ).

B. **26.1 What are the Objectives of this Part? *(Replaces 23.43)**

This part seeks to achieve several objectives:

(a) To ensure nondiscrimination in the award and administration of DOT-assisted contracts in the Department’s highway, transit, and airport financial assistance programs;

(b) To create a level playing field on which DBEs can compete fairly for DOT-assisted contracts;

(c) To ensure that the Department's DBE program is narrowly tailored in accordance with applicable law;

- (d) To ensure that only firms that fully meet this part's eligibility standards are permitted to participate as DBEs;
- (e) To help remove barriers to the participation of DBEs in DOT- assisted contracts;
- (f) To assist the development of firms that can compete successfully in the marketplace outside the DBE program; and
- (g) To provide appropriate flexibility to recipients of Federal financial assistance in establishing and providing opportunities for DBEs.

26.3 To Whom Does this Part Apply? *(Replaces 23.43)

- (a) If you are a recipient of any of the following types of funds, this part applies to you:
 - (1) Federal-aid highway funds authorized under Titles I (other than Part B) and V of the Intermodal Surface Transportation Efficiency Act of 1991 (ISTEA), Pub. L. 102-240, 105 Stat. 1914, or Titles I, III, and V of the Transportation Equity Act for the 21st Century (TEA-21), Pub. L. 105-178, 112 Stat. 107.
 - (2) Federal transit funds authorized by Titles I, III, V and VI of ISTEA, Pub. L. 102-240 or by Federal transit laws in Title 49, U.S. Code, or Titles I, III, and V of the TEA-21, Pub. L. 105-178.
 - (3) Airport funds authorized by 49 U.S.C. 47101, et seq.
- (b) [Reserved]
- (c) If you are letting a contract, and that contract is to be performed entirely outside the United States, its territories and possessions, Puerto Rico, Guam, or the Northern Marianas Islands, this part does not apply to the contract.
- (d) If you are letting a contract in which DOT financial assistance does not participate, this part does not apply to the contract.

26.13 What Assurances Must Recipients and Contractors Make? *(Replaces 23.43)

- (a) Each financial assistance agreement you sign with a DOT operating administration (or a primary recipient) must include the following assurance:

The recipient shall not discriminate on the basis of race, color, national origin, or sex in the award and performance of any DOT-assisted contract or in the administration of its DBE program or the requirements of 49 CFR part 26. The recipient shall take all necessary and reasonable steps under 49 CFR part 26 to ensure nondiscrimination in the award and administration of DOT-assisted contracts. The recipient's DBE program, as required by 49 CFR part 26 and as approved by DOT, is incorporated by reference in this agreement. Implementation of this program is a legal obligation and failure to carry out its terms shall be treated as a violation of this agreement. Upon notification to the recipient of its failure to carry out its approved program, the Department may impose sanctions as provided for under part 26 and may, in appropriate cases, refer the matter for enforcement under 18 U.S.C. 1001 and/or the Program Fraud Civil Remedies Act of 1986 (31 U.S.C. 3801 et seq.).

- (b) Each contract you sign with a contractor (and each subcontract the prime contractor signs with a subcontractor) must include the following assurance:

The contractor, sub recipient or subcontractor shall not discriminate on the basis of race, color, national origin, or sex in the performance of this contract. The contractor shall carry out applicable requirements of 49 CFR part 26 in the award and administration of DOT- assisted contracts. Failure by the contractor to carry out these requirements is a material breach of this contract, which may result in the termination of this contract or such other remedy as the recipient deems appropriate.

C. 26.55 How is DBE Participation Counted Toward Goals? *(Replaces 23.47)

- (a) When a DBE participates in a contract, you count only the value of the work actually performed by the DBE toward DBE goals.

(1) Count the entire amount of that portion of a construction contract (or other contract not covered by paragraph (a)(2) of this section) that is performed by the DBE's own forces. Include the cost of supplies and materials obtained by the DBE for the work of the contract, including supplies purchased or equipment leased by the DBE (except supplies and equipment the DBE subcontractor purchases or leases from the prime contractor or its affiliate).

(2) Count the entire amount of fees or commissions charged by a DBE firm for providing a bona fide service, such as professional, technical, consultant, or managerial services, or for providing bonds or insurance specifically required for the performance of a DOT-assisted contract, toward DBE goals, provided you determine the fee to be reasonable and not excessive as compared with fees customarily allowed for similar services.

(3) When a DBE subcontracts part of the work of its contract to another firm, the value of the subcontracted work may be counted toward DBE goals only if the DBE's subcontractor is itself a DBE. Work that a DBE subcontracts to a non-DBE firm does not count toward DBE goals.

(b) When a DBE performs as a participant in a joint venture, count a portion of the total dollar value of the contract equal to the distinct, clearly defined portion of the work of the contract that the DBE performs with its own forces toward DBE goals.

(c) Count expenditures to a DBE contractor toward DBE goals only if the DBE is performing a commercially useful function on that contract.

(1) A DBE performs a commercially useful function when it is responsible for execution of the work of the contract and is carrying out its responsibilities by actually performing, managing, and supervising the work involved. To perform a commercially useful function, the DBE must also be responsible, with respect to materials and supplies used on the contract, for negotiating price, determining quality and quantity, ordering the material, and installing (where applicable) and paying for the material itself. To determine whether a DBE is performing a commercially useful function, you must evaluate the amount of work subcontracted, industry practices, whether the amount the firm is to be paid under the contract is commensurate with the work it is actually performing and the DBE credit claimed for its performance of the work, and other relevant factors.

(2) A DBE does not perform a commercially useful function if its role is limited to that of an extra participant in a transaction, contract, or project through which funds are passed in order to obtain the appearance of DBE participation. In determining whether a DBE is such an extra participant, you must examine similar transactions, particularly those in which DBEs do not participate.

(3) If a DBE does not perform or exercise responsibility for at least 30 percent of the total cost of its contract with its own work force, or the DBE subcontracts a greater portion of the work of a contract than would be expected on the basis of normal industry practice for the type of work involved, you must presume that it is not performing a commercially useful function.

(4) When a DBE is presumed not to be performing a commercially useful function as provided in paragraph (c)(3) of this section, the DBE may present evidence to rebut this presumption. You may determine that the firm is performing a commercially useful function given the type of work involved and normal industry practices.

(5) Your decisions on commercially useful function matters are subject to review by the concerned operating administration, but are not administratively appealable to DOT.

(d) Use the following factors in determining whether a DBE trucking company is performing a commercially useful function:

(1) The DBE must be responsible for the management and supervision of the entire trucking operation for which it is responsible on a particular contract, and there cannot be a contrived arrangement for the purpose of meeting DBE goals.

(2) The DBE must itself own and operate at least one fully licensed, insured, and operational truck used on the contract.

(3) The DBE receives credit for the total value of the transportation services it provides on the contract using trucks it owns, insures, and operates using drivers it employs.

(4) The DBE may lease trucks from another DBE firm, including an owner-operator who is certified as a DBE. The DBE who leases trucks from another DBE receives credit for the total value of the transportation services the lessee DBE provides on the contract.

(5) The DBE may also lease trucks from a non-DBE firm, including from an owner-operator. The DBE who leases trucks from a non-DBE is entitled to credit only for the fee or commission it receives as a result of the lease arrangement. The DBE does not receive credit for the total value of the transportation services provided by the lessee, since these services are not provided by a DBE.

(6) For purposes of this paragraph (d), a lease must indicate that the DBE has exclusive use of and control over the truck. This does not preclude the leased truck from working for others during the term of the lease with the consent of the DBE, so long as the lease gives the DBE absolute priority for use of the leased truck. Leased trucks must display the name and identification number of the DBE.

(e) Count expenditures with DBEs for materials or supplies toward DBE goals as provided in the following:

(1)(i) If the materials or supplies are obtained from a DBE manufacturer, count 100 percent of the cost of the materials or supplies toward DBE goals.

(ii) For purposes of this paragraph (e)(1), a manufacturer is a firm that operates or maintains a factory or establishment that produces, on the premises, the materials, supplies, articles, or equipment required under the contract and of the general character described by the specifications.

(2)(i) If the materials or supplies are purchased from a DBE regular dealer, count 60 percent of the cost of the materials or supplies toward DBE goals.

(ii) For purposes of this section, a regular dealer is a firm that owns, operates, or maintains a store, warehouse, or other establishment in which the materials, supplies, articles or equipment of the general character described by the specifications and required under the contract are bought, kept in stock, and regularly sold or leased to the public in the usual course of business.

(A) To be a regular dealer, the firm must be an established, regular business that engages, as its principal business and under its own name, in the purchase and sale or lease of the products in question.

(B) A person may be a regular dealer in such bulk items as petroleum products, steel, cement, gravel, stone, or asphalt without owning, operating, or maintaining a place of business as provided in this paragraph (e)(2)(ii) if the person both owns and operates distribution equipment for the products. Any supplementing of regular dealers' own distribution equipment shall be by a long-term lease agreement and not on an ad hoc or contract-by-contract basis.

(C) Packagers, brokers, manufacturers' representatives, or other persons who arrange or expedite transactions are not regular dealers within the meaning of this paragraph (e)(2).

(3) With respect to materials or supplies purchased from a DBE which is neither a manufacturer nor a regular dealer, count the entire amount of fees or commissions charged for assistance in the procurement of the materials and supplies, or fees or transportation charges for the delivery of materials or supplies required on a job site, toward DBE goals, provided you determine the fees to be reasonable and not excessive as compared with fees customarily allowed for similar services. Do not count any portion of the cost of the materials and supplies themselves toward DBE goals, however.

(f) If a firm is not currently certified as a DBE in accordance with the standards of subpart D of this part at the time of the execution of the contract, do not count the firm's participation toward any DBE goals, except as provided for in Sec. 26.87(i).

(g) Do not count the dollar value of work performed under a contract with a firm after it has ceased to be certified toward your overall goal.

(h) Do not count the participation of a DBE subcontractor toward the prime contractor's DBE achievements or your overall goal until the amount being counted toward the goal has been paid to the DBE.

SPECIAL PROVISIONS

23 CFR CH.1 P 4.230, SUBPT..a, APP. A

Specific Equal Employment Opportunity Responsibilities

1. General

- a. Equal employment opportunity requirements not to discriminate and to take affirmative action to assure equal employment opportunity as required by Executive Order 11246 and Executive Order 11375 are set forth in Required Contract Provisions (Form PR-1273 or 1316, as appropriate) and these Special Provisions that are imposed pursuant to Section 140 of Title 23, U.S.C. as established by Section 22 of the Federal Highway Act of 1968. The requirements set forth in these Special Provisions shall constitute the specific affirmative action requirements for project activities under this contract and supplement the equal employment opportunity requirements set forth in the Required Contract Provisions.
- b. The contractor will work with the State highway agencies and the Federal Government in carrying out equal employment opportunity obligations and in their review of his/her activities under the contract.
- c. The contractors and all his/her subcontractors holding subcontracts not including material suppliers, of \$10,000 or more, will comply with the following minimum specific requirement activities of equal employment opportunity: (The equal employment opportunity requirements of Executive Order 11246, as set forth in Volume 6, Chapter 4, Section 1, Subsection 1 of the Federal-Aid Highway Program Manual, are applicable to material suppliers as well as Contractors and Subcontractors.) The Contractor will include these requirements in every subcontract of \$10,000 or more with such modification of language as is necessary to make them binding on the Subcontractor.

2. Equal Employment Opportunity Policy

The contractor will accept as operating policy the following statement which is designed to further the provision of equal employment opportunity to all persons without regard to their race, color, religion, sex, or national origin, and to promote the full realization of equal employment opportunity through a positive continuing program:

It is the policy of this Company to assure that applicants are employed and that employees are treated during employment, without regard to their race, religion, sex, color, or national origin. Such action shall include: employment, upgrading, demotion, or transfer; recruitment or recruitment advertising; layoff or termination; rates of pay or other forms of compensation; and selection for training, including apprenticeship, preapprenticeship, and/or on-the-job training.

3. Equal Employment Opportunity Officer

The contractor will designate and make known to the State highway agency contracting officers an equal employment opportunity officer (hereinafter referred to as the EEO Officer) who will have the responsibility for and must be capable of effectively administering and promoting an active contractor program of equal employment opportunity and who must be assigned adequate authority and responsibility to do so.

4. Dissemination of Policy

- a. All members of the contractor's staff who are authorized to hire, supervise, promote, and discharge employees, or who recommend such action, or who are substantially involved in such action, will be made fully cognizant of, and will implement, the contractor's equal employment opportunity policy and contractual responsibilities to provide equal employment opportunity in each grade and classification of employment. To ensure that the above agreement will be met, the following actions will be taken as a minimum:
 - (1) Periodic meetings of supervisory and personnel office employees will be conducted before the start of work and then not less often than once every six months, at which time the contractor's equal employment opportunity policy and its implementation will be reviewed and explained. The meetings will be conducted by the EEO Officer or other knowledgeable company official.
 - (2) All new supervisory or personnel office employees will be given a thorough indoctrination by the EEO Officer or other knowledgeable company official covering all major aspects of the contractor's equal employment opportunity obligations within thirty days following their reporting for duty with the contractor.
 - (3) All personnel who are engaged in direct recruitment for the project will be instructed by the EEO Officer or appropriate company official in the contractor's procedures for locating and hiring minority group employees.
- b. In order to make the contractor's equal employment opportunity policy known to all employees, prospective employees, and potential sources of employees, i.e., schools, employment agencies, labor unions (where appropriate), college placement officers,

etc., the contractor will take the following actions:

- (1) Notice and posters setting forth the contractor's equal employment opportunity policy will be placed in areas readily accessible to employees, applicants for employment, and potential employees.
- (2) The contractor's equal employment opportunity policy and the procedures to implement such policy will be brought to the attention of employees by means of meetings, employee handbooks, or other appropriate means.

5. Recruitment

- a. When advertising for employees, the contractor will include in all advertisements for employees the notation: "An Equal Opportunity Employer." All such advertisements will be published in newspapers or other publications having a large circulation among minority groups in the area from which the project work force would normally be derived.
- b. The contractor will, unless precluded by a valid bargaining agreement, conduct systematic and direct recruitment through public and private employee referral sources likely to yield qualified minority group applicants, including but not limited to, State employment agencies, schools, colleges, and minority group organizations. To meet this requirement, the contractor will, through his EEO Officer, identify sources of potential minority group employees, and establish with such identified sources of procedures whereby minority group applicants may be referred to the Contractor for employment consideration.

In the event the contractor has a valid bargaining agreement providing for exclusive hiring hall referrals, he is expected to observe the provisions of that agreement to the extent that the system permits the contractor's compliance with equal employment opportunity contract provisions. (The U.S. Department of Labor has held that where implementation of such agreements have the effect of discriminating against minorities or women, or obligates the contractor to do the same, such implementation violates Executive Order 11246, as amended.)

- c. The contractor will encourage his present employees to refer minority group applicants for employment by posting appropriate notices or bulletins in areas accessible to all such employees. In addition, information and procedures with regard to referring minority group applicants will be discussed with employees.

6. Personnel Actions

Wages, working conditions, and employee benefits shall be established and administered, and personnel actions of every type, including hiring, upgrading, promotion, transfer, demotion, layoff, and termination, shall be taken without regard to race, color, religion, sex, or national origin. The following procedures shall be followed:

- a. The contractor will conduct periodic inspections of project sites to ensure that working conditions and employee facilities do not indicate discriminatory treatment of project site personnel.
- b. The contractor will periodically evaluate the spread of wages paid within each classification to determine any evidence of discriminatory wage practices.
- c. The contractor will periodically review selected personnel actions in depth to determine whether there is evidence of discrimination. Where evidence is found, the Contractor will promptly take corrective action. If the review indicates that the discrimination may extend beyond the actions reviewed, such corrective action shall include all affected persons.
- d. The contractor will promptly investigate all complaints of alleged discrimination made to the contractor in connection with his obligations under this contract, will attempt to resolve such complaints, and will take appropriate corrective action within a reasonable time. If the investigation indicates that the discrimination may affect persons other than the complainant, such corrective action shall include such other persons. Upon completion of each investigation, the contractor will inform every complainant of all avenues of appeal.

7. Training and Promotion

- a. The contractor will assist in locating, qualifying, and increasing the skill of minority group and women employees, and applicants for employment.
- b. Consistent with the contractor's work force requirements and as permissible under Federal and State regulations, the Contractor shall make full use of training programs i.e., apprenticeship and on-the-job training programs for the geographical area of contract performance. Where feasible, 25 percent of apprentices or trainees in each occupation shall be in their first year of apprenticeship or training. In the event the Training Special Provision is provided under this contract, this subparagraph will be superseded as indicated in Attachment 2.
- c. The contractor will advise employees and applicants for employment of available training programs and entrance requirements for each.
- d. The contractor will periodically review the training and promotion potential of minority group and women employees and will

encourage eligible employees to apply for such training and promotion.

8. Unions

If the contractor relies in whole or in part upon unions as a source of employees, the contractor will use his/her best efforts to obtain the cooperation of such unions to increase opportunities for minority groups and women within the unions, and to effect referrals by such unions of minority and female employees. Actions by the contractor either directly or through a contractor's association acting as agent will include the procedures set forth below:

- a. The contractor will use best efforts to develop, in cooperation with the unions, joint training programs aimed toward qualifying more minority group members and women for membership in the unions and increasing the skills of minority group employees and women so that they may qualify for higher paying employment.
- b. The contractor will use their best efforts to incorporate an equal employment opportunity clause into each union agreement to the end that such union will be contractually bound to refer applicants without regard to their race, color, religion, sex, or national origin.
- c. The contractor is to obtain information as to the referral practices and policies of the labor union except that to the extent such information is within the exclusive possession of the labor union and such labor union refuses to furnish such information to the contractor, the contractor shall so certify to the State highway department and shall set forth what efforts have been made to obtain such information.
- d. In the event the union is unable to provide the contractor with a reasonable flow of minority and women referrals within the time limit set forth in the collective bargaining agreement, the contractor will, through independent recruitment efforts, fill the employment vacancies without regard to race, color, religion, sex, or national origin, making full efforts to obtain qualified and/or qualifiable minority group persons and women. (The U.S. Department of Labor has held that it shall be no excuse that the union with which the contractor has a collective bargaining agreement providing for exclusive referral failed to refer minority employees.) In the event the union referral practice prevents the contractor from meeting the obligations pursuant to Executive Order 11246, as amended, and these special provisions, such contractor shall immediately notify the State highway agency.

9. Subcontracting

- a. The contractor will use his best efforts to solicit bids from and to utilize minority group subcontractors or subcontractors with meaningful minority group and female representation among their employees. Contractors shall obtain lists of minority-owned construction firms from State highway agency personnel.
- b. The contractor will use his best efforts to ensure subcontractor compliance with their equal employment opportunity obligations.

10. Records and Reports

- a. The contractor will keep such records as are necessary to determine compliance with the contractor's equal employment opportunity obligations. The records kept by the contractor will be designed to indicate:
 - (1) the number of minority and non-minority group members and women employed in each work classification on the project;
 - (2) the progress and efforts being made in cooperation with unions to increase employment opportunities for minorities and women (applicable only to contractors who rely in whole or in part on unions as a source of their work force),
 - (3) the progress and efforts being made in locating, hiring, training, qualifying, and upgrading minority and female employees, and the progress and efforts being made in securing the services of minority group subcontractors or subcontractors with meaningful minority and female representation among their employees.
- b. All such records must be retained for a period of three years following completion of the contract work and shall be available at reasonable times and places for inspection by authorized representatives of the State highway agency and the Federal Highway Administration.
- c. The contractor will submit to the State highway agency a monthly report for the first three months after construction begins and every month of July for the duration of the project, indicating the number of minority, women, and non-minority group employees currently engaged in each work classification required by the contract work. This information is to be reported on Form PR-1391. If on-the-job training is being required by "Training Special Provision," the contractor will be required to furnish Form FHWA 1409.

**REQUIRED CONTRACT PROVISIONS
FEDERAL-AID CONSTRUCTION CONTRACTS**

- I. General
- II. Nondiscrimination
- III. Nonsegregated Facilities
- IV. Davis-Bacon and Related Act Provisions
- V. Contract Work Hours and Safety Standards Act Provisions
- VI. Subletting or Assigning the Contract
- VII. Safety: Accident Prevention
- VIII. False Statements Concerning Highway Projects
- IX. Implementation of Clean Air Act and Federal Water Pollution Control Act
- X. Compliance with Governmentwide Suspension and Debarment Requirements
- XI. Certification Regarding Use of Contract Funds for Lobbying

ATTACHMENTS

A. Employment and Materials Preference for Appalachian Development Highway System or Appalachian Local Access Road Contracts (included in Appalachian contracts only)

I. GENERAL

1. Form FHWA-1273 must be physically incorporated in each construction contract funded under Title 23 (excluding emergency contracts solely intended for debris removal). The contractor (or subcontractor) must insert this form in each subcontract and further require its inclusion in all lower tier subcontracts (excluding purchase orders, rental agreements and other agreements for supplies or services).

The applicable requirements of Form FHWA-1273 are incorporated by reference for work done under any purchase order, rental agreement or agreement for other services. The prime contractor shall be responsible for compliance by any subcontractor, lower-tier subcontractor or service provider.

Form FHWA-1273 must be included in all Federal-aid design-build contracts, in all subcontracts and in lower tier subcontracts (excluding subcontracts for design services, purchase orders, rental agreements and other agreements for supplies or services). The design-builder shall be responsible for compliance by any subcontractor, lower-tier subcontractor or service provider.

Contracting agencies may reference Form FHWA-1273 in bid proposal or request for proposal documents, however, the Form FHWA-1273 must be physically incorporated (not referenced) in all contracts, subcontracts and lower-tier subcontracts (excluding purchase orders, rental agreements and other agreements for supplies or services related to a construction contract).

2. Subject to the applicability criteria noted in the following sections, these contract provisions shall apply to all work performed on the contract by the contractor's own organization and with the assistance of workers under the contractor's immediate superintendence and to all work performed on the contract by piecework, station work, or by subcontract.

3. A breach of any of the stipulations contained in these Required Contract Provisions may be sufficient grounds for withholding of progress payments, withholding of final payment, termination of the contract, suspension / debarment or any other action determined to be appropriate by the contracting agency and FHWA.

4. Selection of Labor: During the performance of this contract, the contractor shall not use convict labor for any purpose within the limits of a construction project on a Federal-aid highway unless it is labor performed by convicts who are on parole, supervised release, or probation. The term Federal-aid highway does not include roadways functionally classified as local roads or rural minor collectors.

II. NONDISCRIMINATION

The provisions of this section related to 23 CFR Part 230 are applicable to all Federal-aid construction contracts and to all related construction subcontracts of \$10,000 or more. The provisions of 23 CFR Part 230 are not applicable to material supply, engineering, or architectural service contracts.

In addition, the contractor and all subcontractors must comply with the following policies: Executive Order 11246, 41 CFR 60, 29 CFR 1625-1627, Title 23 USC Section 140, the Rehabilitation Act of 1973, as amended (29 USC 794), Title VI of the Civil Rights Act of 1964, as amended, and related regulations including 49 CFR Parts 21, 26 and 27; and 23 CFR Parts 200, 230, and 633.

The contractor and all subcontractors must comply with: the requirements of the Equal Opportunity Clause in 41 CFR 60-1.4(b) and, for all construction contracts exceeding \$10,000, the Standard Federal Equal Employment Opportunity Construction Contract Specifications in 41 CFR 60-4.3.

Note: The U.S. Department of Labor has exclusive authority to determine compliance with Executive Order 11246 and the policies of the Secretary of Labor including 41 CFR 60, and 29 CFR 1625-1627. The contracting agency and the FHWA have the authority and the responsibility to ensure compliance with Title 23 USC Section 140, the Rehabilitation Act of 1973, as amended (29 USC 794), and Title VI of the Civil Rights Act of 1964, as amended, and related regulations including 49 CFR Parts 21, 26 and 27; and 23 CFR Parts 200, 230, and 633.

The following provision is adopted from 23 CFR 230, Appendix A, with appropriate revisions to conform to the U.S. Department of Labor (US DOL) and FHWA requirements.

1. Equal Employment Opportunity: Equal employment opportunity (EEO) requirements not to discriminate and to take affirmative action to assure equal opportunity as set forth under laws, executive orders, rules, regulations (28 CFR 35, 29 CFR 1630, 29 CFR 1625-1627, 41 CFR 60 and 49 CFR 27) and orders of the Secretary of Labor as modified by the provisions prescribed herein, and imposed pursuant to 23 U.S.C. 140 shall constitute the EEO and specific affirmative action standards for the contractor's project activities under

this contract. The provisions of the Americans with Disabilities Act of 1990 (42 U.S.C. 12101 et seq.) set forth under 28 CFR 35 and 29 CFR 1630 are incorporated by reference in this contract. In the execution of this contract, the contractor agrees to comply with the following minimum specific requirement activities of EEO:

a. The contractor will work with the contracting agency and the Federal Government to ensure that it has made every good faith effort to provide equal opportunity with respect to all of its terms and conditions of employment and in their review of activities under the contract.

b. The contractor will accept as its operating policy the following statement:

"It is the policy of this Company to assure that applicants are employed, and that employees are treated during employment, without regard to their race, religion, sex, color, national origin, age or disability. Such action shall include: employment, upgrading, demotion, or transfer; recruitment or recruitment advertising; layoff or termination; rates of pay or other forms of compensation; and selection for training, including apprenticeship, pre-apprenticeship, and/or on-the-job training."

2. EEO Officer: The contractor will designate and make known to the contracting officers an EEO Officer who will have the responsibility for and must be capable of effectively administering and promoting an active EEO program and who must be assigned adequate authority and responsibility to do so.

3. Dissemination of Policy: All members of the contractor's staff who are authorized to hire, supervise, promote, and discharge employees, or who recommend such action, or who are substantially involved in such action, will be made fully cognizant of, and will implement, the contractor's EEO policy and contractual responsibilities to provide EEO in each grade and classification of employment. To ensure that the above agreement will be met, the following actions will be taken as a minimum:

a. Periodic meetings of supervisory and personnel office employees will be conducted before the start of work and then not less often than once every six months, at which time the contractor's EEO policy and its implementation will be reviewed and explained. The meetings will be conducted by the EEO Officer.

b. All new supervisory or personnel office employees will be given a thorough indoctrination by the EEO Officer, covering all major aspects of the contractor's EEO obligations within thirty days following their reporting for duty with the contractor.

c. All personnel who are engaged in direct recruitment for the project will be instructed by the EEO Officer in the contractor's procedures for locating and hiring minorities and women.

d. Notices and posters setting forth the contractor's EEO policy will be placed in areas readily accessible to employees, applicants for employment and potential employees.

e. The contractor's EEO policy and the procedures to implement such policy will be brought to the attention of employees by means of meetings, employee handbooks, or other appropriate means.

4. Recruitment: When advertising for employees, the contractor will include in all advertisements for employees the notation: "An Equal Opportunity Employer." All such advertisements will be placed in publications having a large circulation among minorities and women in the area from which the project work force would normally be derived.

a. The contractor will, unless precluded by a valid bargaining agreement, conduct systematic and direct recruitment through public and private employee referral sources likely to yield qualified minorities and women. To meet this requirement, the contractor will identify sources of potential minority group employees, and establish with such identified sources procedures whereby minority and women applicants may be referred to the contractor for employment consideration.

b. In the event the contractor has a valid bargaining agreement providing for exclusive hiring hall referrals, the contractor is expected to observe the provisions of that agreement to the extent that the system meets the contractor's compliance with EEO contract provisions. Where implementation of such an agreement has the effect of discriminating against minorities or women, or obligates the contractor to do the same, such implementation violates Federal nondiscrimination provisions.

c. The contractor will encourage its present employees to refer minorities and women as applicants for employment. Information and procedures with regard to referring such applicants will be discussed with employees.

5. Personnel Actions: Wages, working conditions, and employee benefits shall be established and administered, and personnel actions of every type, including hiring, upgrading, promotion, transfer, demotion, layoff, and termination, shall be taken without regard to race, color, religion, sex, national origin, age or disability. The following procedures shall be followed:

a. The contractor will conduct periodic inspections of project sites to insure that working conditions and employee facilities do not indicate discriminatory treatment of project site personnel.

b. The contractor will periodically evaluate the spread of wages paid within each classification to determine any evidence of discriminatory wage practices.

c. The contractor will periodically review selected personnel actions in depth to determine whether there is evidence of discrimination. Where evidence is found, the contractor will promptly take corrective action. If the review indicates that the discrimination may extend beyond the actions reviewed, such corrective action shall include all affected persons.

d. The contractor will promptly investigate all complaints of alleged discrimination made to the contractor in connection with its obligations under this contract, will attempt to resolve such complaints, and will take appropriate corrective action within a reasonable time. If the investigation indicates that the discrimination may affect persons other than the complainant, such corrective action shall include such other persons. Upon completion of each investigation, the contractor will inform every complainant of all of their avenues of appeal.

6. Training and Promotion:

a. The contractor will assist in locating, qualifying, and increasing the skills of minorities and women who are

applicants for employment or current employees. Such efforts should be aimed at developing full journey level status employees in the type of trade or job classification involved.

b. Consistent with the contractor's work force requirements and as permissible under Federal and State regulations, the contractor shall make full use of training programs, i.e., apprenticeship, and on-the-job training programs for the geographical area of contract performance. In the event a special provision for training is provided under this contract, this subparagraph will be superseded as indicated in the special provision. The contracting agency may reserve training positions for persons who receive welfare assistance in accordance with 23 U.S.C. 140(a).

c. The contractor will advise employees and applicants for employment of available training programs and entrance requirements for each.

d. The contractor will periodically review the training and promotion potential of employees who are minorities and women and will encourage eligible employees to apply for such training and promotion.

7. Unions: If the contractor relies in whole or in part upon unions as a source of employees, the contractor will use good faith efforts to obtain the cooperation of such unions to increase opportunities for minorities and women. Actions by the contractor, either directly or through a contractor's association acting as agent, will include the procedures set forth below:

a. The contractor will use good faith efforts to develop, in cooperation with the unions, joint training programs aimed toward qualifying more minorities and women for membership in the unions and increasing the skills of minorities and women so that they may qualify for higher paying employment.

b. The contractor will use good faith efforts to incorporate an EEO clause into each union agreement to the end that such union will be contractually bound to refer applicants without regard to their race, color, religion, sex, national origin, age or disability.

c. The contractor is to obtain information as to the referral practices and policies of the labor union except that to the extent such information is within the exclusive possession of the labor union and such labor union refuses to furnish such information to the contractor, the contractor shall so certify to the contracting agency and shall set forth what efforts have been made to obtain such information.

d. In the event the union is unable to provide the contractor with a reasonable flow of referrals within the time limit set forth in the collective bargaining agreement, the contractor will, through independent recruitment efforts, fill the employment vacancies without regard to race, color, religion, sex, national origin, age or disability; making full efforts to obtain qualified and/or qualifiable minorities and women. The failure of a union to provide sufficient referrals (even though it is obligated to provide exclusive referrals under the terms of a collective bargaining agreement) does not relieve the contractor from the requirements of this paragraph. In the event the union referral practice prevents the contractor from meeting the obligations pursuant to Executive Order 11246, as amended, and these special provisions, such contractor shall immediately notify the contracting agency.

8. Reasonable Accommodation for Applicants / Employees with Disabilities: The contractor must be familiar

with the requirements for and comply with the Americans with Disabilities Act and all rules and regulations established there under. Employers must provide reasonable accommodation in all employment activities unless to do so would cause an undue hardship.

9. Selection of Subcontractors, Procurement of Materials and Leasing of Equipment: The contractor shall not discriminate on the grounds of race, color, religion, sex, national origin, age or disability in the selection and retention of subcontractors, including procurement of materials and leases of equipment. The contractor shall take all necessary and reasonable steps to ensure nondiscrimination in the administration of this contract.

a. The contractor shall notify all potential subcontractors and suppliers and lessors of their EEO obligations under this contract.

b. The contractor will use good faith efforts to ensure subcontractor compliance with their EEO obligations.

10. Assurance Required by 49 CFR 26.13(b):

a. The requirements of 49 CFR Part 26 and the State DOT's U.S. DOT-approved DBE program are incorporated by reference.

b. The contractor or subcontractor shall not discriminate on the basis of race, color, national origin, or sex in the performance of this contract. The contractor shall carry out applicable requirements of 49 CFR Part 26 in the award and administration of DOT-assisted contracts. Failure by the contractor to carry out these requirements is a material breach of this contract, which may result in the termination of this contract or such other remedy as the contracting agency deems appropriate.

11. Records and Reports: The contractor shall keep such records as necessary to document compliance with the EEO requirements. Such records shall be retained for a period of three years following the date of the final payment to the contractor for all contract work and shall be available at reasonable times and places for inspection by authorized representatives of the contracting agency and the FHWA.

a. The records kept by the contractor shall document the following:

(1) The number and work hours of minority and non-minority group members and women employed in each work classification on the project;

(2) The progress and efforts being made in cooperation with unions, when applicable, to increase employment opportunities for minorities and women; and

(3) The progress and efforts being made in locating, hiring, training, qualifying, and upgrading minorities and women;

b. The contractors and subcontractors will submit an annual report to the contracting agency each July for the duration of the project, indicating the number of minority, women, and non-minority group employees currently engaged in each work classification required by the contract work. This information is to be reported on [Form FHWA-1391](#). The staffing data should represent the project work force on board in all or any part of the last payroll period preceding the end of July. If on-the-job training is being required by special provision, the contractor

will be required to collect and report training data. The employment data should reflect the work force on board during all or any part of the last payroll period preceding the end of July.

III. NONSEGREGATED FACILITIES

This provision is applicable to all Federal-aid construction contracts and to all related construction subcontracts of \$10,000 or more.

The contractor must ensure that facilities provided for employees are provided in such a manner that segregation on the basis of race, color, religion, sex, or national origin cannot result. The contractor may neither require such segregated use by written or oral policies nor tolerate such use by employee custom. The contractor's obligation extends further to ensure that its employees are not assigned to perform their services at any location, under the contractor's control, where the facilities are segregated. The term "facilities" includes waiting rooms, work areas, restaurants and other eating areas, time clocks, restrooms, washrooms, locker rooms, and other storage or dressing areas, parking lots, drinking fountains, recreation or entertainment areas, transportation, and housing provided for employees. The contractor shall provide separate or single-user restrooms and necessary dressing or sleeping areas to assure privacy between sexes.

IV. DAVIS-BACON AND RELATED ACT PROVISIONS

This section is applicable to all Federal-aid construction projects exceeding \$2,000 and to all related subcontracts and lower-tier subcontracts (regardless of subcontract size). The requirements apply to all projects located within the right-of-way of a roadway that is functionally classified as Federal-aid highway. This excludes roadways functionally classified as local roads or rural minor collectors, which are exempt. Contracting agencies may elect to apply these requirements to other projects.

The following provisions are from the U.S. Department of Labor regulations in 29 CFR 5.5 "Contract provisions and related matters" with minor revisions to conform to the FHWA-1273 format and FHWA program requirements.

1. Minimum wages

a. All laborers and mechanics employed or working upon the site of the work, will be paid unconditionally and not less often than once a week, and without subsequent deduction or rebate on any account (except such payroll deductions as are permitted by regulations issued by the Secretary of Labor under the Copeland Act (29 CFR part 3)), the full amount of wages and bona fide fringe benefits (or cash equivalents thereof) due at time of payment computed at rates not less than those contained in the wage determination of the Secretary of Labor which is attached hereto and made a part hereof, regardless of any contractual relationship which may be alleged to exist between the contractor and such laborers and mechanics.

Contributions made or costs reasonably anticipated for bona fide fringe benefits under section 1(b)(2) of the Davis-Bacon Act on behalf of laborers or mechanics are considered wages paid to such laborers or mechanics, subject to the provisions

of paragraph 1.d. of this section; also, regular contributions made or costs incurred for more than a weekly period (but not less often than quarterly) under plans, funds, or programs which cover the particular weekly period, are deemed to be constructively made or incurred during such weekly period. Such laborers and mechanics shall be paid the appropriate wage rate and fringe benefits on the wage determination for the classification of work actually performed, without regard to skill, except as provided in 29 CFR 5.5(a)(4). Laborers or mechanics performing work in more than one classification may be compensated at the rate specified for each classification for the time actually worked therein: Provided, That the employer's payroll records accurately set forth the time spent in each classification in which work is performed. The wage determination (including any additional classification and wage rates conformed under paragraph 1.b. of this section) and the Davis-Bacon poster (WH-1321) shall be posted at all times by the contractor and its subcontractors at the site of the work in a prominent and accessible place where it can be easily seen by the workers.

b. (1) The contracting officer shall require that any class of laborers or mechanics, including helpers, which is not listed in the wage determination and which is to be employed under the contract shall be classified in conformance with the wage determination. The contracting officer shall approve an additional classification and wage rate and fringe benefits therefore only when the following criteria have been met:

(i) The work to be performed by the classification requested is not performed by a classification in the wage determination; and

(ii) The classification is utilized in the area by the construction industry; and

(iii) The proposed wage rate, including any bona fide fringe benefits, bears a reasonable relationship to the wage rates contained in the wage determination.

(2) If the contractor and the laborers and mechanics to be employed in the classification (if known), or their representatives, and the contracting officer agree on the classification and wage rate (including the amount designated for fringe benefits where appropriate), a report of the action taken shall be sent by the contracting officer to the Administrator of the Wage and Hour Division, Employment Standards Administration, U.S. Department of Labor, Washington, DC 20210. The Administrator, or an authorized representative, will approve, modify, or disapprove every additional classification action within 30 days of receipt and so advise the contracting officer or will notify the contracting officer within the 30-day period that additional time is necessary.

(3) In the event the contractor, the laborers or mechanics to be employed in the classification or their representatives, and the contracting officer do not agree on the proposed classification and wage rate (including the amount designated for fringe benefits, where appropriate), the contracting officer shall refer the questions, including the views of all interested parties and the recommendation of the contracting officer, to the Wage and Hour Administrator for determination. The Wage and Hour Administrator, or an authorized representative, will issue a determination within 30 days of receipt and so advise the contracting officer or

will notify the contracting officer within the 30-day period that additional time is necessary.

(4) The wage rate (including fringe benefits where appropriate) determined pursuant to paragraphs 1.b.(2) or 1.b.(3) of this section, shall be paid to all workers performing work in the classification under this contract from the first day on which work is performed in the classification.

c. Whenever the minimum wage rate prescribed in the contract for a class of laborers or mechanics includes a fringe benefit which is not expressed as an hourly rate, the contractor shall either pay the benefit as stated in the wage determination or shall pay another bona fide fringe benefit or an hourly cash equivalent thereof.

d. If the contractor does not make payments to a trustee or other third person, the contractor may consider as part of the wages of any laborer or mechanic the amount of any costs reasonably anticipated in providing bona fide fringe benefits under a plan or program. Provided, That the Secretary of Labor has found, upon the written request of the contractor, that the applicable standards of the Davis-Bacon Act have been met. The Secretary of Labor may require the contractor to set aside in a separate account assets for the meeting of obligations under the plan or program.

2. Withholding

The contracting agency shall upon its own action or upon written request of an authorized representative of the Department of Labor, withhold or cause to be withheld from the contractor under this contract, or any other Federal contract with the same prime contractor, or any other federally-assisted contract subject to Davis-Bacon prevailing wage requirements, which is held by the same prime contractor, so much of the accrued payments or advances as may be considered necessary to pay laborers and mechanics, including apprentices, trainees, and helpers, employed by the contractor or any subcontractor the full amount of wages required by the contract. In the event of failure to pay any laborer or mechanic, including any apprentice, trainee, or helper, employed or working on the site of the work, all or part of the wages required by the contract, the contracting agency may, after written notice to the contractor, take such action as may be necessary to cause the suspension of any further payment, advance, or guarantee of funds until such violations have ceased.

3. Payrolls and basic records

a. Payrolls and basic records relating thereto shall be maintained by the contractor during the course of the work and preserved for a period of three years thereafter for all laborers and mechanics working at the site of the work. Such records shall contain the name, address, and social security number of each such worker, his or her correct classification, hourly rates of wages paid (including rates of contributions or costs anticipated for bona fide fringe benefits or cash equivalents thereof of the types described in section 1(b)(2)(B) of the Davis-Bacon Act), daily and weekly number of hours worked, deductions made and actual wages paid. Whenever the Secretary of Labor has found under 29 CFR 5.5(a)(1)(iv) that the wages of any laborer or mechanic include the amount of any costs reasonably anticipated in providing benefits under a plan or program described in section 1(b)(2)(B) of the Davis-

Bacon Act, the contractor shall maintain records which show that the commitment to provide such benefits is enforceable, that the plan or program is financially responsible, and that the plan or program has been communicated in writing to the laborers or mechanics affected, and records which show the costs anticipated or the actual cost incurred in providing such benefits. Contractors employing apprentices or trainees under approved programs shall maintain written evidence of the registration of apprenticeship programs and certification of trainee programs, the registration of the apprentices and trainees, and the ratios and wage rates prescribed in the applicable programs.

b.(1) The contractor shall submit weekly for each week in which any contract work is performed a copy of all payrolls to the contracting agency. The payrolls submitted shall set out accurately and completely all of the information required to be maintained under 29 CFR 5.5(a)(3)(i), except that full social security numbers and home addresses shall not be included on weekly transmittals. Instead the payrolls shall only need to include an individually identifying number for each employee (e.g., the last four digits of the employee's social security number). The required weekly payroll information may be submitted in any form desired. Optional Form WH-347 is available for this purpose from the Wage and Hour Division Web site at <http://www.dol.gov/esa/whd/forms/wh347instr.htm> or its successor site. The prime contractor is responsible for the submission of copies of payrolls by all subcontractors. Contractors and subcontractors shall maintain the full social security number and current address of each covered worker, and shall provide them upon request to the contracting agency for transmission to the State DOT, the FHWA or the Wage and Hour Division of the Department of Labor for purposes of an investigation or audit of compliance with prevailing wage requirements. It is not a violation of this section for a prime contractor to require a subcontractor to provide addresses and social security numbers to the prime contractor for its own records, without weekly submission to the contracting agency..

(2) Each payroll submitted shall be accompanied by a "Statement of Compliance," signed by the contractor or subcontractor or his or her agent who pays or supervises the payment of the persons employed under the contract and shall certify the following:

(i) That the payroll for the payroll period contains the information required to be provided under §5.5 (a)(3)(ii) of Regulations, 29 CFR part 5, the appropriate information is being maintained under §5.5 (a)(3)(i) of Regulations, 29 CFR part 5, and that such information is correct and complete;

(ii) That each laborer or mechanic (including each helper, apprentice, and trainee) employed on the contract during the payroll period has been paid the full weekly wages earned, without rebate, either directly or indirectly, and that no deductions have been made either directly or indirectly from the full wages earned, other than permissible deductions as set forth in Regulations, 29 CFR part 3;

(iii) That each laborer or mechanic has been paid not less than the applicable wage rates and fringe benefits or cash equivalents for the classification of work performed, as specified in the applicable wage determination incorporated into the contract.

(3) The weekly submission of a properly executed certification set forth on the reverse side of Optional Form WH-347 shall satisfy the requirement for submission of the "Statement of Compliance" required by paragraph 3.b.(2) of this section.

(4) The falsification of any of the above certifications may subject the contractor or subcontractor to civil or criminal prosecution under section 1001 of title 18 and section 231 of title 31 of the United States Code.

c. The contractor or subcontractor shall make the records required under paragraph 3.a. of this section available for inspection, copying, or transcription by authorized representatives of the contracting agency, the State DOT, the FHWA, or the Department of Labor, and shall permit such representatives to interview employees during working hours on the job. If the contractor or subcontractor fails to submit the required records or to make them available, the FHWA may, after written notice to the contractor, the contracting agency or the State DOT, take such action as may be necessary to cause the suspension of any further payment, advance, or guarantee of funds. Furthermore, failure to submit the required records upon request or to make such records available may be grounds for debarment action pursuant to 29 CFR 5.12.

4. Apprentices and trainees

a. Apprentices (programs of the USDOL).

Apprentices will be permitted to work at less than the predetermined rate for the work they performed when they are employed pursuant to and individually registered in a bona fide apprenticeship program registered with the U.S. Department of Labor, Employment and Training Administration, Office of Apprenticeship Training, Employer and Labor Services, or with a State Apprenticeship Agency recognized by the Office, or if a person is employed in his or her first 90 days of probationary employment as an apprentice in such an apprenticeship program, who is not individually registered in the program, but who has been certified by the Office of Apprenticeship Training, Employer and Labor Services or a State Apprenticeship Agency (where appropriate) to be eligible for probationary employment as an apprentice.

The allowable ratio of apprentices to journeymen on the job site in any craft classification shall not be greater than the ratio permitted to the contractor as to the entire work force under the registered program. Any worker listed on a payroll at an apprentice wage rate, who is not registered or otherwise employed as stated above, shall be paid not less than the applicable wage rate on the wage determination for the classification of work actually performed. In addition, any apprentice performing work on the job site in excess of the ratio permitted under the registered program shall be paid not less than the applicable wage rate on the wage determination for the work actually performed. Where a contractor is performing construction on a project in a locality other than that in which its program is registered, the ratios and wage rates (expressed in percentages of the journeyman's hourly rate) specified in the contractor's or subcontractor's registered program shall be observed.

Every apprentice must be paid at not less than the rate specified in the registered program for the apprentice's level of progress, expressed as a percentage of the journeymen hourly

rate specified in the applicable wage determination. Apprentices shall be paid fringe benefits in accordance with the provisions of the apprenticeship program. If the apprenticeship program does not specify fringe benefits, apprentices must be paid the full amount of fringe benefits listed on the wage determination for the applicable classification. If the Administrator determines that a different practice prevails for the applicable apprentice classification, fringes shall be paid in accordance with that determination.

In the event the Office of Apprenticeship Training, Employer and Labor Services, or a State Apprenticeship Agency recognized by the Office, withdraws approval of an apprenticeship program, the contractor will no longer be permitted to utilize apprentices at less than the applicable predetermined rate for the work performed until an acceptable program is approved.

b. Trainees (programs of the USDOL).

Except as provided in 29 CFR 5.16, trainees will not be permitted to work at less than the predetermined rate for the work performed unless they are employed pursuant to and individually registered in a program which has received prior approval, evidenced by formal certification by the U.S. Department of Labor, Employment and Training Administration.

The ratio of trainees to journeymen on the job site shall not be greater than permitted under the plan approved by the Employment and Training Administration.

Every trainee must be paid at not less than the rate specified in the approved program for the trainee's level of progress, expressed as a percentage of the journeyman hourly rate specified in the applicable wage determination. Trainees shall be paid fringe benefits in accordance with the provisions of the trainee program. If the trainee program does not mention fringe benefits, trainees shall be paid the full amount of fringe benefits listed on the wage determination unless the Administrator of the Wage and Hour Division determines that there is an apprenticeship program associated with the corresponding journeyman wage rate on the wage determination which provides for less than full fringe benefits for apprentices. Any employee listed on the payroll at a trainee rate who is not registered and participating in a training plan approved by the Employment and Training Administration shall be paid not less than the applicable wage rate on the wage determination for the classification of work actually performed. In addition, any trainee performing work on the job site in excess of the ratio permitted under the registered program shall be paid not less than the applicable wage rate on the wage determination for the work actually performed.

In the event the Employment and Training Administration withdraws approval of a training program, the contractor will no longer be permitted to utilize trainees at less than the applicable predetermined rate for the work performed until an acceptable program is approved.

c. Equal employment opportunity. The utilization of apprentices, trainees and journeymen under this part shall be in conformity with the equal employment opportunity requirements of Executive Order 11246, as amended, and 29 CFR part 30.

d. Apprentices and Trainees (programs of the U.S. DOT).

Apprentices and trainees working under apprenticeship and skill training programs which have been certified by the Secretary of Transportation as promoting EEO in connection with Federal-aid highway construction programs are not subject to the requirements of paragraph 4 of this Section IV. The straight time hourly wage rates for apprentices and trainees under such programs will be established by the particular programs. The ratio of apprentices and trainees to journeymen shall not be greater than permitted by the terms of the particular program.

5. Compliance with Copeland Act requirements. The contractor shall comply with the requirements of 29 CFR part 3, which are incorporated by reference in this contract.

6. Subcontracts. The contractor or subcontractor shall insert Form FHWA-1273 in any subcontracts and also require the subcontractors to include Form FHWA-1273 in any lower tier subcontracts. The prime contractor shall be responsible for the compliance by any subcontractor or lower tier subcontractor with all the contract clauses in 29 CFR 5.5.

7. Contract termination: debarment. A breach of the contract clauses in 29 CFR 5.5 may be grounds for termination of the contract, and for debarment as a contractor and a subcontractor as provided in 29 CFR 5.12.

8. Compliance with Davis-Bacon and Related Act requirements. All rulings and interpretations of the Davis-Bacon and Related Acts contained in 29 CFR parts 1, 3, and 5 are herein incorporated by reference in this contract.

9. Disputes concerning labor standards. Disputes arising out of the labor standards provisions of this contract shall not be subject to the general disputes clause of this contract. Such disputes shall be resolved in accordance with the procedures of the Department of Labor set forth in 29 CFR parts 5, 6, and 7. Disputes within the meaning of this clause include disputes between the contractor (or any of its subcontractors) and the contracting agency, the U.S. Department of Labor, or the employees or their representatives.

10. Certification of eligibility.

a. By entering into this contract, the contractor certifies that neither it (nor he or she) nor any person or firm who has an interest in the contractor's firm is a person or firm ineligible to be awarded Government contracts by virtue of section 3(a) of the Davis-Bacon Act or 29 CFR 5.12(a)(1).

b. No part of this contract shall be subcontracted to any person or firm ineligible for award of a Government contract by virtue of section 3(a) of the Davis-Bacon Act or 29 CFR 5.12(a)(1).

c. The penalty for making false statements is prescribed in the U.S. Criminal Code, 18 U.S.C. 1001.

V. CONTRACT WORK HOURS AND SAFETY STANDARDS ACT

The following clauses apply to any Federal-aid construction contract in an amount in excess of \$100,000 and subject to the overtime provisions of the Contract Work Hours and Safety Standards Act. These clauses shall be inserted in addition to the clauses required by 29 CFR 5.5(a) or 29 CFR 4.6. As used in this paragraph, the terms laborers and mechanics include watchmen and guards.

1. Overtime requirements. No contractor or subcontractor contracting for any part of the contract work which may require or involve the employment of laborers or mechanics shall require or permit any such laborer or mechanic in any workweek in which he or she is employed on such work to work in excess of forty hours in such workweek unless such laborer or mechanic receives compensation at a rate not less than one and one-half times the basic rate of pay for all hours worked in excess of forty hours in such workweek.

2. Violation; liability for unpaid wages; liquidated damages. In the event of any violation of the clause set forth in paragraph (1.) of this section, the contractor and any subcontractor responsible therefor shall be liable for the unpaid wages. In addition, such contractor and subcontractor shall be liable to the United States (in the case of work done under contract for the District of Columbia or a territory, to such District or to such territory), for liquidated damages. Such liquidated damages shall be computed with respect to each individual laborer or mechanic, including watchmen and guards, employed in violation of the clause set forth in paragraph (1.) of this section, in the sum of \$10 for each calendar day on which such individual was required or permitted to work in excess of the standard workweek of forty hours without payment of the overtime wages required by the clause set forth in paragraph (1.) of this section.

3. Withholding for unpaid wages and liquidated damages. The FHWA or the contracting agency shall upon its own action or upon written request of an authorized representative of the Department of Labor withhold or cause to be withheld, from any moneys payable on account of work performed by the contractor or subcontractor under any such contract or any other Federal contract with the same prime contractor, or any other federally-assisted contract subject to the Contract Work Hours and Safety Standards Act, which is held by the same prime contractor, such sums as may be determined to be necessary to satisfy any liabilities of such contractor or subcontractor for unpaid wages and liquidated damages as provided in the clause set forth in paragraph (2.) of this section.

4. Subcontracts. The contractor or subcontractor shall insert in any subcontracts the clauses set forth in paragraph (1.) through (4.) of this section and also a clause requiring the subcontractors to include these clauses in any lower tier subcontracts. The prime contractor shall be responsible for compliance by any subcontractor or lower tier subcontractor with the clauses set forth in paragraphs (1.) through (4.) of this section.

VI. SUBLETTING OR ASSIGNING THE CONTRACT

This provision is applicable to all Federal-aid construction contracts on the National Highway System.

1. The contractor shall perform with its own organization contract work amounting to not less than 30 percent (or a greater percentage if specified elsewhere in the contract) of the total original contract price, excluding any specialty items designated by the contracting agency. Specialty items may be performed by subcontract and the amount of any such specialty items performed may be deducted from the total original contract price before computing the amount of work required to be performed by the contractor's own organization (23 CFR 635.116).

a. The term "perform work with its own organization" refers to workers employed or leased by the prime contractor, and equipment owned or rented by the prime contractor, with or without operators. Such term does not include employees or equipment of a subcontractor or lower tier subcontractor, agents of the prime contractor, or any other assignees. The term may include payments for the costs of hiring leased employees from an employee leasing firm meeting all relevant Federal and State regulatory requirements. Leased employees may only be included in this term if the prime contractor meets all of the following conditions:

(1) the prime contractor maintains control over the supervision of the day-to-day activities of the leased employees;

(2) the prime contractor remains responsible for the quality of the work of the leased employees;

(3) the prime contractor retains all power to accept or exclude individual employees from work on the project; and

(4) the prime contractor remains ultimately responsible for the payment of predetermined minimum wages, the submission of payrolls, statements of compliance and all other Federal regulatory requirements.

b. "Specialty Items" shall be construed to be limited to work that requires highly specialized knowledge, abilities, or equipment not ordinarily available in the type of contracting organizations qualified and expected to bid or propose on the contract as a whole and in general are to be limited to minor components of the overall contract.

2. The contract amount upon which the requirements set forth in paragraph (1) of Section VI is computed includes the cost of material and manufactured products which are to be purchased or produced by the contractor under the contract provisions.

3. The contractor shall furnish (a) a competent superintendent or supervisor who is employed by the firm, has full authority to direct performance of the work in accordance with the contract requirements, and is in charge of all construction operations (regardless of who performs the work) and (b) such other of its own organizational resources (supervision, management, and engineering services) as the contracting officer determines is necessary to assure the performance of the contract.

4. No portion of the contract shall be sublet, assigned or otherwise disposed of except with the written consent of the contracting officer, or authorized representative, and such consent when given shall not be construed to relieve the contractor of any responsibility for the fulfillment of the contract. Written consent will be given only after the contracting agency has assured that each subcontract is

evidenced in writing and that it contains all pertinent provisions and requirements of the prime contract.

5. The 30% self-performance requirement of paragraph (1) is not applicable to design-build contracts; however, contracting agencies may establish their own self-performance requirements.

VII. SAFETY: ACCIDENT PREVENTION

This provision is applicable to all Federal-aid construction contracts and to all related subcontracts.

1. In the performance of this contract the contractor shall comply with all applicable Federal, State, and local laws governing safety, health, and sanitation (23 CFR 635). The contractor shall provide all safeguards, safety devices and protective equipment and take any other needed actions as it determines, or as the contracting officer may determine, to be reasonably necessary to protect the life and health of employees on the job and the safety of the public and to protect property in connection with the performance of the work covered by the contract.

2. It is a condition of this contract, and shall be made a condition of each subcontract, which the contractor enters into pursuant to this contract, that the contractor and any subcontractor shall not permit any employee, in performance of the contract, to work in surroundings or under conditions which are unsanitary, hazardous or dangerous to his/her health or safety, as determined under construction safety and health standards (29 CFR 1926) promulgated by the Secretary of Labor, in accordance with Section 107 of the Contract Work Hours and Safety Standards Act (40 U.S.C. 3704).

3. Pursuant to 29 CFR 1926.3, it is a condition of this contract that the Secretary of Labor or authorized representative thereof, shall have right of entry to any site of contract performance to inspect or investigate the matter of compliance with the construction safety and health standards and to carry out the duties of the Secretary under Section 107 of the Contract Work Hours and Safety Standards Act (40 U.S.C.3704).

VIII. FALSE STATEMENTS CONCERNING HIGHWAY PROJECTS

This provision is applicable to all Federal-aid construction contracts and to all related subcontracts.

In order to assure high quality and durable construction in conformity with approved plans and specifications and a high degree of reliability on statements and representations made by engineers, contractors, suppliers, and workers on Federal-aid highway projects, it is essential that all persons concerned with the project perform their functions as carefully, thoroughly, and honestly as possible. Willful falsification, distortion, or misrepresentation with respect to any facts related to the project is a violation of Federal law. To prevent any misunderstanding regarding the seriousness of these and similar acts, Form FHWA-1022 shall be posted on each Federal-aid highway project (23 CFR 635) in one or more places where it is readily available to all persons concerned with the project:

18 U.S.C. 1020 reads as follows:

"Whoever, being an officer, agent, or employee of the United States, or of any State or Territory, or whoever, whether a person, association, firm, or corporation, knowingly makes any false statement, false representation, or false report as to the character, quality, quantity, or cost of the material used or to be used, or the quantity or quality of the work performed or to be performed, or the cost thereof in connection with the submission of plans, maps, specifications, contracts, or costs of construction on any highway or related project submitted for approval to the Secretary of Transportation; or

Whoever knowingly makes any false statement, false representation, false report or false claim with respect to the character, quality, quantity, or cost of any work performed or to be performed, or materials furnished or to be furnished, in connection with the construction of any highway or related project approved by the Secretary of Transportation; or

Whoever knowingly makes any false statement or false representation as to material fact in any statement, certificate, or report submitted pursuant to provisions of the Federal-aid Roads Act approved July 1, 1916, (39 Stat. 355), as amended and supplemented;

Shall be fined under this title or imprisoned not more than 5 years or both."

IX. IMPLEMENTATION OF CLEAN AIR ACT AND FEDERAL WATER POLLUTION CONTROL ACT

This provision is applicable to all Federal-aid construction contracts and to all related subcontracts.

By submission of this bid/proposal or the execution of this contract, or subcontract, as appropriate, the bidder, proposer, Federal-aid construction contractor, or subcontractor, as appropriate, will be deemed to have stipulated as follows:

1. That any person who is or will be utilized in the performance of this contract is not prohibited from receiving an award due to a violation of Section 508 of the Clean Water Act or Section 306 of the Clean Air Act.

2. That the contractor agrees to include or cause to be included the requirements of paragraph (1) of this Section X in every subcontract, and further agrees to take such action as the contracting agency may direct as a means of enforcing such requirements.

X. CERTIFICATION REGARDING DEBARMENT, SUSPENSION, INELIGIBILITY AND VOLUNTARY EXCLUSION

This provision is applicable to all Federal-aid construction contracts, design-build contracts, subcontracts, lower-tier subcontracts, purchase orders, lease agreements, consultant contracts or any other covered transaction requiring FHWA approval or that is estimated to cost \$25,000 or more – as defined in 2 CFR Parts 180 and 1200.

1. Instructions for Certification – First Tier Participants:

a. By signing and submitting this proposal, the prospective first tier participant is providing the certification set out below.

b. The inability of a person to provide the certification set out below will not necessarily result in denial of participation in this

covered transaction. The prospective first tier participant shall submit an explanation of why it cannot provide the certification set out below. The certification or explanation will be considered in connection with the department or agency's determination whether to enter into this transaction. However, failure of the prospective first tier participant to furnish a certification or an explanation shall disqualify such a person from participation in this transaction.

c. The certification in this clause is a material representation of fact upon which reliance was placed when the contracting agency determined to enter into this transaction. If it is later determined that the prospective participant knowingly rendered an erroneous certification, in addition to other remedies available to the Federal Government, the contracting agency may terminate this transaction for cause of default.

d. The prospective first tier participant shall provide immediate written notice to the contracting agency to whom this proposal is submitted if any time the prospective first tier participant learns that its certification was erroneous when submitted or has become erroneous by reason of changed circumstances.

e. The terms "covered transaction," "debarred," "suspended," "ineligible," "participant," "person," "principal," and "voluntarily excluded," as used in this clause, are defined in 2 CFR Parts 180 and 1200. "First Tier Covered Transactions" refers to any covered transaction between a grantee or subgrantee of Federal funds and a participant (such as the prime or general contract). "Lower Tier Covered Transactions" refers to any covered transaction under a First Tier Covered Transaction (such as subcontracts). "First Tier Participant" refers to the participant who has entered into a covered transaction with a grantee or subgrantee of Federal funds (such as the prime or general contractor). "Lower Tier Participant" refers any participant who has entered into a covered transaction with a First Tier Participant or other Lower Tier Participants (such as subcontractors and suppliers).

f. The prospective first tier participant agrees by submitting this proposal that, should the proposed covered transaction be entered into, it shall not knowingly enter into any lower tier covered transaction with a person who is debarred, suspended, declared ineligible, or voluntarily excluded from participation in this covered transaction, unless authorized by the department or agency entering into this transaction.

g. The prospective first tier participant further agrees by submitting this proposal that it will include the clause titled "Certification Regarding Debarment, Suspension, Ineligibility and Voluntary Exclusion-Lower Tier Covered Transactions," provided by the department or contracting agency, entering into this covered transaction, without modification, in all lower tier covered transactions and in all solicitations for lower tier covered transactions exceeding the \$25,000 threshold.

h. A participant in a covered transaction may rely upon a certification of a prospective participant in a lower tier covered transaction that is not debarred, suspended, ineligible, or voluntarily excluded from the covered transaction, unless it knows that the certification is erroneous. A participant is responsible for ensuring that its principals are not suspended, debarred, or otherwise ineligible to participate in covered transactions. To verify the eligibility of its principals, as well as the eligibility of any lower tier prospective participants, each participant may, but is not required to, check the Excluded Parties List System website (<https://www.epls.gov/>), which is compiled by the General Services Administration.

i. Nothing contained in the foregoing shall be construed to require the establishment of a system of records in order to render in good faith the certification required by this clause. The knowledge and information of the prospective participant is not required to exceed that which is normally possessed by a prudent person in the ordinary course of business dealings.

j. Except for transactions authorized under paragraph (f) of these instructions, if a participant in a covered transaction knowingly enters into a lower tier covered transaction with a person who is suspended, debarred, ineligible, or voluntarily excluded from participation in this transaction, in addition to other remedies available to the Federal Government, the department or agency may terminate this transaction for cause or default.

* * * * *

2. Certification Regarding Debarment, Suspension, Ineligibility and Voluntary Exclusion – First Tier Participants:

a. The prospective first tier participant certifies to the best of its knowledge and belief, that it and its principals:

(1) Are not presently debarred, suspended, proposed for debarment, declared ineligible, or voluntarily excluded from participating in covered transactions by any Federal department or agency;

(2) Have not within a three-year period preceding this proposal been convicted of or had a civil judgment rendered against them for commission of fraud or a criminal offense in connection with obtaining, attempting to obtain, or performing a public (Federal, State or local) transaction or contract under a public transaction; violation of Federal or State antitrust statutes or commission of embezzlement, theft, forgery, bribery, falsification or destruction of records, making false statements, or receiving stolen property;

(3) Are not presently indicted for or otherwise criminally or civilly charged by a governmental entity (Federal, State or local) with commission of any of the offenses enumerated in paragraph (a)(2) of this certification; and

(4) Have not within a three-year period preceding this application/proposal had one or more public transactions (Federal, State or local) terminated for cause or default.

b. Where the prospective participant is unable to certify to any of the statements in this certification, such prospective participant shall attach an explanation to this proposal.

2. Instructions for Certification - Lower Tier Participants:

(Applicable to all subcontracts, purchase orders and other lower tier transactions requiring prior FHWA approval or estimated to cost \$25,000 or more - 2 CFR Parts 180 and 1200)

a. By signing and submitting this proposal, the prospective lower tier is providing the certification set out below.

b. The certification in this clause is a material representation of fact upon which reliance was placed when this transaction was entered into. If it is later determined that the prospective lower tier participant knowingly rendered an erroneous certification, in addition to other remedies available to the Federal Government, the department, or agency with which

this transaction originated may pursue available remedies, including suspension and/or debarment.

c. The prospective lower tier participant shall provide immediate written notice to the person to which this proposal is submitted if at any time the prospective lower tier participant learns that its certification was erroneous by reason of changed circumstances.

d. The terms "covered transaction," "debarred," "suspended," "ineligible," "participant," "person," "principal," and "voluntarily excluded," as used in this clause, are defined in 2 CFR Parts 180 and 1200. You may contact the person to which this proposal is submitted for assistance in obtaining a copy of those regulations. "First Tier Covered Transactions" refers to any covered transaction between a grantee or subgrantee of Federal funds and a participant (such as the prime or general contract). "Lower Tier Covered Transactions" refers to any covered transaction under a First Tier Covered Transaction (such as subcontracts). "First Tier Participant" refers to the participant who has entered into a covered transaction with a grantee or subgrantee of Federal funds (such as the prime or general contractor). "Lower Tier Participant" refers any participant who has entered into a covered transaction with a First Tier Participant or other Lower Tier Participants (such as subcontractors and suppliers).

e. The prospective lower tier participant agrees by submitting this proposal that, should the proposed covered transaction be entered into, it shall not knowingly enter into any lower tier covered transaction with a person who is debarred, suspended, declared ineligible, or voluntarily excluded from participation in this covered transaction, unless authorized by the department or agency with which this transaction originated.

f. The prospective lower tier participant further agrees by submitting this proposal that it will include this clause titled "Certification Regarding Debarment, Suspension, Ineligibility and Voluntary Exclusion-Lower Tier Covered Transaction," without modification, in all lower tier covered transactions and in all solicitations for lower tier covered transactions exceeding the \$25,000 threshold.

g. A participant in a covered transaction may rely upon a certification of a prospective participant in a lower tier covered transaction that is not debarred, suspended, ineligible, or voluntarily excluded from the covered transaction, unless it knows that the certification is erroneous. A participant is responsible for ensuring that its principals are not suspended, debarred, or otherwise ineligible to participate in covered transactions. To verify the eligibility of its principals, as well as the eligibility of any lower tier prospective participants, each participant may, but is not required to, check the Excluded Parties List System website (<https://www.epls.gov/>), which is compiled by the General Services Administration.

h. Nothing contained in the foregoing shall be construed to require establishment of a system of records in order to render in good faith the certification required by this clause. The knowledge and information of participant is not required to exceed that which is normally possessed by a prudent person in the ordinary course of business dealings.

i. Except for transactions authorized under paragraph e of these instructions, if a participant in a covered transaction knowingly enters into a lower tier covered transaction with a person who is suspended, debarred, ineligible, or voluntarily excluded from participation in this transaction, in addition to other remedies available to the Federal Government, the

department or agency with which this transaction originated may pursue available remedies, including suspension and/or debarment.

* * * * *

Certification Regarding Debarment, Suspension, Ineligibility and Voluntary Exclusion--Lower Tier Participants:

1. The prospective lower tier participant certifies, by submission of this proposal, that neither it nor its principals is presently debarred, suspended, proposed for debarment, declared ineligible, or voluntarily excluded from participating in covered transactions by any Federal department or agency.

2. Where the prospective lower tier participant is unable to certify to any of the statements in this certification, such prospective participant shall attach an explanation to this proposal.

* * * * *

XI. CERTIFICATION REGARDING USE OF CONTRACT FUNDS FOR LOBBYING

This provision is applicable to all Federal-aid construction contracts and to all related subcontracts which exceed \$100,000 (49 CFR 20).

1. The prospective participant certifies, by signing and submitting this bid or proposal, to the best of his or her knowledge and belief, that:

a. No Federal appropriated funds have been paid or will be paid, by or on behalf of the undersigned, to any person for influencing or attempting to influence an officer or employee of any Federal agency, a Member of Congress, an officer or employee of Congress, or an employee of a Member of Congress in connection with the awarding of any Federal contract, the making of any Federal grant, the making of any Federal loan, the entering into of any cooperative agreement, and the extension, continuation, renewal, amendment, or modification of any Federal contract, grant, loan, or cooperative agreement.

b. If any funds other than Federal appropriated funds have been paid or will be paid to any person for influencing or attempting to influence an officer or employee of any Federal agency, a Member of Congress, an officer or employee of Congress, or an employee of a Member of Congress in connection with this Federal contract, grant, loan, or cooperative agreement, the undersigned shall complete and submit Standard Form-LLL, "Disclosure Form to Report Lobbying," in accordance with its instructions.

2. This certification is a material representation of fact upon which reliance was placed when this transaction was made or entered into. Submission of this certification is a prerequisite for making or entering into this transaction imposed by 31 U.S.C. 1352. Any person who fails to file the required certification shall be subject to a civil penalty of not less than \$10,000 and not more than \$100,000 for each such failure.

3. The prospective participant also agrees by submitting its bid or proposal that the participant shall require that the language of this certification be included in all lower tier subcontracts, which exceed \$100,000 and that all such recipients shall certify and disclose accordingly.

ATTACHMENT A - EMPLOYMENT AND MATERIALS PREFERENCE FOR APPALACHIAN DEVELOPMENT HIGHWAY SYSTEM OR APPALACHIAN LOCAL ACCESS ROAD CONTRACTS

This provision is applicable to all Federal-aid projects funded under the Appalachian Regional Development Act of 1965.

1. During the performance of this contract, the contractor undertaking to do work which is, or reasonably may be, done as on-site work, shall give preference to qualified persons who regularly reside in the labor area as designated by the DOL wherein the contract work is situated, or the subregion, or the Appalachian counties of the State wherein the contract work is situated, except:

a. To the extent that qualified persons regularly residing in the area are not available.

b. For the reasonable needs of the contractor to employ supervisory or specially experienced personnel necessary to assure an efficient execution of the contract work.

c. For the obligation of the contractor to offer employment to present or former employees as the result of a lawful collective bargaining contract, provided that the number of nonresident persons employed under this subparagraph (1c) shall not exceed 20 percent of the total number of employees employed by the contractor on the contract work, except as provided in subparagraph (4) below.

2. The contractor shall place a job order with the State Employment Service indicating (a) the classifications of the laborers, mechanics and other employees required to perform the contract work, (b) the number of employees required in each classification, (c) the date on which the participant estimates such employees will be required, and (d) any other pertinent information required by the State Employment Service to complete the job order form. The job order may be placed with the State Employment Service in writing or by telephone. If during the course of the contract work, the information submitted by the contractor in the original job order is substantially modified, the participant shall promptly notify the State Employment Service.

3. The contractor shall give full consideration to all qualified job applicants referred to him by the State Employment Service. The contractor is not required to grant employment to any job applicants who, in his opinion, are not qualified to perform the classification of work required.

4. If, within one week following the placing of a job order by the contractor with the State Employment Service, the State Employment Service is unable to refer any qualified job applicants to the contractor, or less than the number requested, the State Employment Service will forward a certificate to the contractor indicating the unavailability of applicants. Such certificate shall be made a part of the contractor's permanent project records. Upon receipt of this certificate, the contractor may employ persons who do not normally reside in the labor area to fill positions covered by the certificate, notwithstanding the provisions of subparagraph (1c) above.

5. The provisions of 23 CFR 633.207(e) allow the contracting agency to provide a contractual preference for the use of mineral resource materials native to the Appalachian region.

6. The contractor shall include the provisions of Sections 1 through 4 of this Attachment A in every subcontract for work which is, or reasonably may be, done as on-site work.

NOTICE TO BIDDERS

CERTIFIED PAYROLLS

- A. Certified weekly payrolls covering the contractor's and all subcontractor's work forces shall be submitted to the Resident/Delivery Engineer along with the Weekly Employment Report (Form 1199) on all federally funded projects in accordance with CFR 29, Part 3, except these requirements shall not apply to any contract of \$2,000 or less, or county negotiated projects, or projects located on roadways classified as local or rural minor collectors, or projects located off the federal-aid highway system.
- B. Certified weekly payrolls covering the contractor's and the subcontractor's work force will not be required of STATE FUNDED PROJECTS. However, the Weekly Employment Report (Form 1199) shall be submitted to the Delivery Engineer on all STATE FUNDED PROJECTS of \$10,000 or more and employing three or more people.
- C. On those contracts involving two or more projects and job numbers and the type of funding is mixed, the necessity for submission of payrolls will be determined on a contract by contract basis. If the Department puts only the wage rates issued by the U.S. Department of Labor in the proposal, payrolls must be submitted on all projects and the federal requirements apply. If the Department includes both the wage rates issued by the U.S. Department of Labor and the Michigan Department of Labor, then the wage requirements apply to the respective federally funded and non-federally funded project.

All payrolls submitted shall identify minority and female employees by preceding the name with an ethnic code notation. Ethnic code groups are (B) Black, (H) Hispanic, (NA) American Indian or Alaskan Eskimo, and (A) Asian or Pacific Islander. Use (F) for female.

All payrolls shall also identify each employee's work classification, including level, i.e., Laborer Group 1, 2, etc., Operating Engineer Group 1, 2, etc., Truck Driver under 6.1 m³, etc.

Payrolls on federally funded projects are used for determining compliance with federal wage standard provisions.

These requirements are supplemental to other required contract provisions carried in this bid proposal.

03-05-04 (Rev.)

NOTICE TO BIDDERS

REPORT FORMS

FORM NUMBER:

1366 - "CONTRACTOR'S AFFIDAVIT OF INDEBTEDNESS"

1367 - "CONSENT OF SURETY TO PAYMENT TO CONTRACTOR"

The above listed forms will originate with the Construction Contract Section (Payment Unit) of Contract Services Division. They are sent out to the contractor (a) upon receipt of an estimate to reduce the reserve to a lump sum or (b) upon receipt of a final estimate.

The contractor must execute Form 1366 and forward along with Form 1367 to their surety company for the Surety's consent. Both of these forms are then returned to Michigan Department of Transportation's Contract Services Division. **These forms must be submitted to Agreements/Payments/Purchasing Section before a reduction in Reserve Estimate or a Final Estimate is paid.**

FHWA-47 - "STATEMENT OF MATERIALS AND LABOR USED BY CONTRACTORS ON HIGHWAY CONSTRUCTION INVOLVING FEDERAL FUNDS"

This form submitted by the contractor is required before final payment for federal projects over \$1,000,000.

1120 - "ACCEPTANCE REPORT"

This form will be initiated and submitted by the Region Engineer.

1199(06/01) - "WEEKLY EMPLOYMENT REPORT"

This form replaces forms 103B, 103F, 109, PR-1391, and 1199 (12/94). Form 1199 is to be submitted by the contractor to the Resident/Project Engineer when any of the following occurs:

1. Submitting certified payrolls on federally funded projects of \$2,000 or more, except county negotiated projects, or projects located on roadways classified as local or rural minor collectors, or projects located off the federal-aid highway system.
2. On state funded projects of \$10,000 or more and employing three or more people.
3. When work is performed the last week of July.

0125 - "MONTHLY OJT PILOT PROGRAM REPORT AND TRAINING LOG"

This form replaces Form 1199(12/94). Form 0125 is to be submitted by the contractor to MDOT, Office of Equal Opportunity and a copy to the Resident/Delivery Engineer when the following occurs:

1. Reporting the training record for the on-the-job training.

03-05-04 (rev.)

**NOTICE OF REQUIREMENT FOR AFFIRMATIVE ACTION
TO ENSURE EQUAL EMPLOYMENT OPPORTUNITY**

(EXECUTIVE ORDER 11246)

- 1. The offeror's or bidder's attention is called to the "Equal Opportunity Clause" and the "Standard Federal Employment Specifications" set forth herein.
- 2. The goals and timetables for minority and female participation, expressed in percentage terms for the Contractor's aggregate workforce in each trade on all construction work in the covered area, are as follows:

Timetables:

Goals for Minority participation for each trade: 5.2% %

Goals for female participation in each trade: 6.9 %

These goals are applicable to all the contractor's construction work (whether or not it is Federal or federally assisted) performed in the covered area. If the contractor performs construction work in a geographical area located outside of the covered area, it shall apply the goals established for such geographical area where the work is actually performed. With regard to this second area, the contractor also is subject to the goals for both its federally involved and nonfederally involved construction.

The Contractor's compliance with the regulations in CFR Part 60-4 shall be based on its implementation of the Equal Opportunity Clause, specific affirmative action obligation required by the specifications set forth in 41 CFR 60-4.3 (a), and its efforts to meet the goals. The hours of minority and female employment and training must be substantially uniform throughout the length of the contract, and in each trade, and the Contractor shall make a good faith effort to employ minorities and women evenly on each of its projects. The transfer of minority or female employees or trainees from contractor to contractor or from project to project for the sole purpose of meeting the Contractor's goals shall be a violation of the contract, the Executive Order and the regulations in 41 CFR Part 60.4. Compliance with the goals will be measured against the total work hours performed.

CONTRACTOR SHALL COMPLY

- 3. The Contractor shall provide written notification to the *DIRECTOR OF THE OFFICE OF FEDERAL CONTRACT COMPLIANCE PROGRAMS within ten (10) working days of award of any construction subcontract in excess of \$10,000 at any tier for construction work under the contract resulting from this solicitation. The notification shall list the name, address and telephone number of the subcontractor; employer identification number; estimated dollar amount of the subcontract; estimated starting and completion dates of the subcontract; and the geographical area in which the contract is to be performed.

* Notification shall be forwarded to the OFCCP office for the county in which the project is located. See page 6 for the proper address.

- 4. As used in this Notice, and in the contract resulting from this solicitation, the "covered area" is: State

**STANDARD FEDERAL EQUAL EMPLOYMENT OPPORTUNITY
CONSTRUCTION CONTRACT SPECIFICATIONS
(EXECUTIVE ORDER 11246)**

1. **As used in these specifications:**
 - a. **“Covered area” means the geographical area described in the solicitation from which this contract resulted;**
 - b. **“Director” means Director, Office of Federal Contract Compliance Programs, United States Department of Labor, or any person to whom the Director delegates authority;**
 - c. **“Employer identification number” means the Federal Social Security number used on the Employer’s Quarterly Federal Tax Return, U.S. Treasury Department Form 941.**
 - d. **“Minority” includes:**
 - (i) **Black (all person having origins in any of the Black African racial groups not of Hispanic origin); and**
 - (ii) **Hispanic (all persons of Mexican, Puerto Rican, Cuban, Central or South American or other Spanish Culture of origin, regardless of race); and**
 - (iii) **Asian and Pacific Islander (all persons having origins in any of the original peoples of the Far East, South East Asia, the Indian Subcontinent, or the Pacific Islands); and**
 - (iv) **American Indian or Alaskan Native (all persons having origins in any of the original peoples of North America and maintaining identifiable tribal affiliations through membership and participation and participation or community identification).**
2. **Whenever the Contractor, or any Subcontractor at any tier, subcontracts a portion of the work involving any construction trade, it shall physically include in each subcontract in excess of \$10,000 the provisions of these specifications and the Notice which contains the applicable goals for minority and female participation and which is set forth in the solicitation from which this contract resulted.**
3. **If the Contractor is participating (pursuant to 41 CFR 60.4.5) in a Hometown Plan approved by the U.S. Department of Labor in the covered area either individually or through an association, its affirmative action obligations on all work in the Plan area (including goals and timetables) shall be in accordance with that Plan for those trades which have unions participating in the Plan. Contractors must be able to demonstrate their participation in and compliance with the provisions of any such**

Hometown Plan. Each Contractor or Subcontractor participating in an approved Plan is individually required to comply with its obligations under the EEO clause, and to make good faith effort to achieve each goal under the Plan in each trade in which it has employees. The overall good faith performance by other Contractors or Subcontractors toward a goal in an approved Plan does not excuse any covered Contractor's or Subcontractor's failure to take good faith efforts to achieve the Plan goals and timetables.

- 4. The Contractor shall implement the specific affirmative action standards provided in paragraph 7a through p of these specifications. The goals set forth in the solicitation from which this contract resulted are expressed as percentages of the total hours of employment and training of minority and female utilization the Contractor should reasonably be able to achieve in each construction trade in which it has employees in the covered area. Covered construction contractors performing construction work in geographical areas where they do not have a Federal or federally assisted construction contract shall apply the minority and female goals established for the geographical area where the work is being performed. Goals are published periodically in the Federal Register in notice form, and such notices may be obtained from any Office of Federal Contract Compliance Programs office or from Federal procurement contracting officers. The Contractor is expected to make substantially uniform progress in meeting its goals in each craft during the period specified.**
- 5. Neither the provisions of any collective bargaining agreement, nor the failure by a union with whom the Contractor has collective bargaining agreement, to refer either minorities or women shall excuse the Contractor's obligations under these specifications, Executive Order 11246, or the regulations promulgated pursuant thereto.**
- 6. In order for the nonworking training hours of apprentices and trainees to be counted in meeting the goals, such apprentices and trainees must be employed by the Contractor during the training period, and the Contractor must have made a commitment to employ the apprentices and trainees at the completion of their training, subject to the availability of employment opportunities. Trainees must be trained pursuant to training programs approved by the U.S. Department of Labor.**
- 7. The Contractor shall take specific affirmative actions to ensure equal employment opportunity. The evaluation of the Contractor's compliance with these specifications shall be based upon its effort to achieve maximum results from its actions. The Contractor shall document these efforts fully, and shall implement affirmative action steps at least as extensive as the following:**
 - a. Ensure and maintain a working environment free of harassment, intimidation, and coercion at all sites, and in all facilities at which the Contractor's employees are assigned to work. The Contractor, where possible, will assign two or more women to each construction project. The Contractor shall specifically ensure that all foremen, superintendents, and other on-site supervisory personnel are aware of and carry out the Contractor's obligation to maintain such a working environment, with specific attention to minority or female individuals working at such sites or in such facilities.**
 - b. Establish and maintain a current list of minority and female recruitment sources, provide written notification to minority and female recruitment sources and to community organizations when the Contractor or its unions have employment opportunities available, and maintain a record of the organizations' responses.**
 - c. Maintain a current file of the names, addresses and telephone numbers of each minority and female off-the-street applicant and minority or female referral from a union, a**

recruitment source or community organization and of what action was taken with respect to each such individual. If such individual was sent to the union hiring hall for referral and was not referred back to the Contractor by the union or, if referred, not employed by the Contractor, this shall be documented in the file with the reason therefor, along with whatever additional actions the Contractor may have taken.

- d. Provide immediate written notification to the Director when the union or unions with which the Contractor has a collective bargaining agreement has not referred to the Contractor a minority person or woman sent by the Contractor, or when the Contractor has other information that the union referral process has impeded the contractor's efforts to meet its obligations.
- e. Develop on-the-job training opportunities and/or participate in training programs for the area which expressly include upgrading programs and apprenticeship and trainee programs relevant to the contractor's employment needs, especially those programs funded or approved by the Department of Labor. The Contractor shall provide notice of these programs to the sources complied under 7b above.
- f. Disseminate the Contractor's EEO policy by providing notice of the policy to unions and training programs and requesting their cooperation in assisting the Contractor in meeting its EEO obligations; by including it in any policy review of the policy with all management personnel and with all minority and female employees at least once a year; and by posting the company EEO policy on bulletin boards accessible to all employees at each location where construction is performed.
- g. Review, at least annually, the company's EEO policy and affirmative action obligations under these specifications with all employees having any responsibility for hiring, assignment, layoff, termination or other employment decisions including specific review of these items with onsite supervisory personnel such as Superintendents, General Foremen, etc., prior to the initiation of construction work at any job site. A written record shall be made and maintained identifying the time and place of these meetings, persons attending, subject matter discussed, and disposition of the subject matter.
- h. Disseminate the Contractor's EEO policy externally by including it in any advertising in the news media, specifically including minority and female news media, and providing written notification to and discussing the Contractor's EEO policy with other Contractors and Subcontractors with whom the Contractor does or anticipates doing business.
- I. Direct its recruitment efforts, both oral and written, to minority, female and community organizations, to schools with minority and female students and to minority and female recruitment and training organizations serving the Contractor's recruitment area and employment needs. Not later than one month prior to the date for the acceptance of applications for apprenticeship or other training by any recruitment source, the Contractor shall send written notification to organizations such as the above, describing the openings, screening procedures, and tests to be used in the selection process.
- j. Encourage present minority and female employees to recruit other minority persons and women and, where reasonable, provide after school, summer and vacation employment to minority and female youth both on the site and in other areas of a

Contractor's workforce.

- k. Validate all tests and other selection requirements where there is an obligation to do so under 41 CFR Part 60.3.**
 - l. Conduct, at least annually, an inventory and evaluation at least of all minority and female personnel for promotional opportunities and encourage these employees to seek or to prepare for, through appropriate training, etc., such opportunities.**
 - m. Ensure that seniority practices, job classifications, work assignments and other personnel practices, do not have a discriminatory effect by continually monitoring all personnel and employment related activities to ensure that the EEO policy and the Contractor's obligations under these specifications are being carried out.**
 - n. Ensure that all facilities and company activities are nonsegregated except that separate or single-user toilet and necessary changing facilities shall be provided to assure privacy between the sexes.**
 - o. Document and maintain a record of all solicitations of offers for subcontracts from minority and female construction contractors and suppliers, including circulation of solicitations to minority and female contractor associations and other business associations.**
 - p. Conduct a review, at least annually, of all supervisors' adherence to and performance under the Contractor's EEO policies and affirmative action obligations.**
- 8. Contractors are encouraged to participate in voluntary associations which assist in fulfilling one or more of their affirmative action obligations (7a through p). The efforts of a contractor association, joint contractor-union, contractor-community, or other similar group of which the contractor is a member and participant, may be asserted as fulfilling any one or more of its obligations under 7a through p of these Specifications provided that the contractor actively participates in the group, makes every effort to assure that the group has a positive impact on the employment of minorities and women in the industry, ensures that the concrete benefits of the program are reflected in the Contractor's minority and female workforce participation, makes a good faith effort to meet its individual goals and timetable, and can provide access to documentation which demonstrates the effectiveness of actions taken on behalf of the Contractor. The obligation to comply, however, is the Contractor's and failure of such a group to fulfill an obligation shall not be a defense for the Contractor's noncompliance.**
- 9. A single goal for minorities and separate single goal for women have been established. The Contractor, however, is required to provide equal employment opportunity and to take affirmative action for all minority groups, both male and female, and all women, both minority and non-minority. Consequently, the Contractor may be in violation of the Executive Order if a particular group is employed in a substantially disparate manner (for example, even though the Contractor has achieved its goals for women generally, the Contractor may be in violation of the Executive Order if a specific minority group of women is underutilized).**
- 10. The Contractor shall not use the goals and timetables or affirmative action standards to discriminate against any person because of race, color, religion, sex, or national origin.**
- 11. The Contractor shall not enter into any subcontract with any person or firm debarred from Government contracts pursuant to Executive Order 11246.**

12. The Contractor shall carry out such sanctions and penalties for violation of these specifications and of the Equal Opportunity Clause, including suspension, termination and cancellation of existing subcontracts as may be imposed or ordered pursuant to Executive Order 11246, as amended, and its implementing regulations, by the Office of Federal Contract Compliance Programs. Any Contractor who fails to carry out such sanctions and penalties shall be in violation of these specifications and Executive Order 11246, as amended.
13. The Contractor, in fulfilling its obligations under these specifications, shall implement specific affirmative action steps, at least as extensive as those standards prescribed in paragraph 7 of these specifications, so as to achieve maximum results from its efforts to ensure equal employment opportunity. If the Contractor fails to comply with the requirements of the Executive Order, the implementing regulations, or these specifications, the Director shall proceed in accordance with 41 CFR 60-4.8.
14. The Contractor shall designate a responsible official to monitor all employment related activity to ensure that the company EEO policy is being carried out, to submit reports relating to the provisions hereof as may be required by the Government and to keep records. Records shall at least include for each employee the name, address, telephone numbers, construction trade, union affiliation if any, employee identification number when assigned, social security number, race, sex, status (e.g. mechanic, apprentice, trainee, helper, or laborer), dates of changes in status, hours worked per week in the indicated trade, rate of pay, and locations at which the work was performed. Records shall be maintained in an easily understandable and retrievable form; however, to the degree that existing records satisfy this requirement, contractors shall not be required to maintain separate records.
15. Nothing herein provided shall be construed as a limitation upon the application of other laws which establish different standards of compliance or upon the application of requirements for the hiring of local or other area residents (e.g. those under the Public Works Employment Act of 1977 and the Community Development Block Grant Program).

Detroit Area Office

Christopher Edwards, Area Office Director
 U.S. DOL/ESA/OFCCP
 Detroit Area Office
 211 West Fort Street
 Detroit, Michigan 48226
 Phone: 313/226-3728

Michigan Counties:

Alcona	Benzie	Clare	Grand Traverse	Isabella	Lenawee
Allegan	Berrien	Clinton	Gratiot	Kalamazoo	Livingston
Alpena	Branch	Crawford	Hillsdale	Kalkaska	Macomb
Antrim	Calhoun	Eaton	Huron	Kent	Manistee
Arenac	Cass	Emmet	Ingham	Lake	Mason
Barry	Charlevoix	Genesee	Ionia	Lapeer	Mecosta
Bay	Cheboygan	Gladwin	Iosco	Leelanau	Midland

Michigan Counties:

Missaukee	Oceana	Roscommon	Van Buren
Monroe	Ogemaw	St. Clair	Washtenaw
Montcalm	Osceola	St. Joseph	Wayne
Montmorency	Oscoda	Saginaw	Wexford
Muskegon	Otsego	Sanilac	
Newaygo	Ottawa	Shiawassee	
Oakland	Presque Isle	Tuscola	

Milwaukee Area Office

**Mr. Robert Potter
U.S. DOL/ESA/OFCCP
Milwaukee Area Office
Reuss Federal Bldg., Room 1115
310 West Wisconsin
Milwaukee, Wisconsin 53203
Phone: 414/291-3822**

Michigan Counties:

Alger	Delta	Houghton	Luce	Menominee
Baraga	Dickinson	Iron	Mackinac	Ontonagon
Chippewa	Gogebic	Keweenaw	Marquette	Schoolcraft

COUNTY MINORITY AND FEMALE
 PERCENTAGES USED BY THE MICHIGAN DEPT. OF TRANSPORTATION
 (To Be Used in Section I of the Attached Title VI Report)

1	Alcona	=	5.2	43	Lake	=	4.9
2	Alger	=	1	44	Lapeer	=	17.7
3	Allegan	=	4.9	45	Leelanau	=	4.9
4	Alpena	=	5.2	46	Lenawee	=	7.3
5	Antrim	=	4.9	47	Livingston	=	17.5
6	Arenac	=	5.2	48	Luce	=	5.2
7	Baraga	=	1	49	Mackinac	=	5.2
8	Barry	=	7.2	50	Macomb	=	17.7
9	Bay	=	2.2	51	Manistee	=	4.9
10	Benzie	=	4.9	52	Marquette	=	1
11	Bemen	=	6.2	53	Mason	=	4.9
12	Branch	=	5.5	54	Mecosta	=	4.9
13	Calhoun	=	7.2	55	Menominee	=	1
14	Cass	=	6.2	56	Midland	=	5.2
15	Charlevoix	=	4.9	57	Missaukee	=	4.9
16	Cheboygan	=	5.2	58	Monroe	=	8.8
17	Chippewa	=	5.2	59	Montcalm	=	4.9
18	Clare	=	5.2	60	Montmorency	=	5.2
19	Clinton	=	5.2	61	Muskegon	=	9.7
20	Crawford	=	5.2	62	Newaygo	=	4.9
21	Delta	=	1	63	Oakland	=	17.7
22	Dickinson	=	1	64	Oceana	=	9.7
23	Eaton	=	5.5	65	Ogemaw	=	5.2
24	Emmet	=	4.9	66	Ontonagon	=	1.2
25	Genesee	=	12.6	67	Osceola	=	4.9
26	Gladwin	=	5.2	68	Oscoda	=	5.2
27	Gogebic	=	1.2	69	Otsego	=	5.2
	Grand						
28	Traverse	=	4.9	70	Ottawa	=	5.2
29	Gratiot	=	5.2	71	Presque Isle	=	5.2
30	Hillsdale	=	5.5	72	Roscommon	=	5.2
31	Houghton	=	1	73	Saginaw	=	14.3
32	Huron	=	5.2	74	Sanilac	=	16.7
33	Ingham	=	5.5	75	Schoolcraft	=	1
34	Ionia	=	5.5	76	Shiawassee	=	12.6
35	Iosco	=	5.2	77	St. Clair	=	17.7
36	Iron	=	1	78	St. Joseph	=	5.2
37	Isabella	=	5.2	79	Tuscola	=	5.2
38	Jackson	=	5.1	80	VanBuren	=	5.9
39	Kalamazoo	=	5.9	81	Washtenaw	=	8.5
40	Kalkaska	=	4.9	82	Wayne	=	17.7
41	Kent	=	5.2	83	Wexford	=	4.9
42	Keweenaw	=	1				

The Contruction goal for women in any Michigan county is 6.9 percent

Minority and female percentages are taken from the office of Federal Contract compliance Programs Statistics

General Decision Number: MI170001 09/08/2017 MI1

Superseded General Decision Number: MI20160001

State: Michigan

Construction Types: Highway (Highway, Airport & Bridge xxxxx and Sewer/Incid. to Hwy.)

Counties: Michigan Statewide.

Note: Under Executive Order (EO) 13658, an hourly minimum wage of \$10.20 for calendar year 2017 applies to all contracts subject to the Davis-Bacon Act for which the contract is awarded (and any solicitation was issued) on or after January 1, 2015. If this contract is covered by the EO, the contractor must pay all workers in any classification listed on this wage determination at least \$10.20 (or the applicable wage rate listed on this wage determination, if it is higher) for all hours spent performing on the contract in calendar year 2017. The EO minimum wage rate will be adjusted annually. Additional information on contractor requirements and worker protections under the EO is available at www.dol.gov/whd/govcontracts.

Modification Number	Publication Date
0	01/06/2017
1	02/03/2017
2	02/17/2017
3	04/28/2017
4	05/19/2017
5	06/02/2017
6	06/23/2017
7	06/30/2017
8	07/21/2017
9	07/28/2017
10	09/08/2017

CARP0004-004 06/01/2016

REMAINDER OF STATE

	Rates	Fringes
CARPENTER (Piledriver).....	\$ 26.33	19.18

CARP0004-005 06/01/2016

LIVINGSTON (Townships of Brighton, Deerfield, Genoa, Hartland, Oceola & Tyrone), MACOMB, MONROE, OAKLAND, SANILAC, ST. CLAIR AND WAYNE COUNTIES

	Rates	Fringes
CARPENTER (Piledriver).....	\$ 29.47	25.94

ELEC0017-005 06/05/2017

STATEWIDE

	Rates	Fringes
Line Construction		
Groundman/Driver.....	\$ 28.16	6.10+28.5%
Journeyman Signal Tech, Communications Tech, Tower		
Tech & Fiber Optic Splicers.	\$ 38.38	6.10+28.5%
Journeyman Specialist.....	\$ 44.14	6.10+28.5%
Operator A.....	\$ 32.45	6.10+28.5%
Operator B.....	\$ 30.30	6.10+28.5%

Classifications

Journeyman Specialist: Refers to a crew of only one person working alone.

Operator A: Shall be proficient in operating all power equipment including: Backhoe, Excavator, Directional Bore and Boom/Digger truck.

Operator B: Shall be proficient in operating any 2 of the above mentioned pieces of equipment listed under Operator A.

ENGI0324-003 06/01/2017

ALCONA, ALPENA, ARENAC, BAY, CHEBOYGAN, CLARE, CLINTON, CRAWFORD, GENESEE, GLADWIN, GRATIOT, HURON, INGHAM, IOSCO, ISABELLA, JACKSON, LAPEER, LENAWEE, LIVINGSTON, MACOMB, MIDLAND, MONROE, MONTMORENCY, OAKLAND, OGEMAW, OSCODA, OTSEGO, PRESQUE ISLE, ROSCOMMON, SAGINAW, ST. CLAIR, SANILAC, SHIAWASSEE, TUSCOLA, WASHTENAW AND WAYNE COUNTIES:

	Rates	Fringes
OPERATOR: Power Equipment (Steel Erection)		
GROUP 1.....	\$ 44.32	23.00
GROUP 2.....	\$ 45.32	23.00
GROUP 3.....	\$ 42.82	23.00
GROUP 4.....	\$ 43.82	23.00
GROUP 5.....	\$ 41.32	23.00
GROUP 6.....	\$ 42.32	23.00
GROUP 7.....	\$ 41.05	23.00
GROUP 8.....	\$ 42.05	23.00
GROUP 9.....	\$ 40.60	23.00
GROUP 10.....	\$ 41.60	23.00
GROUP 11.....	\$ 39.87	23.00
GROUP 12.....	\$ 40.87	23.00
GROUP 13.....	\$ 39.51	23.00
GROUP 14.....	\$ 40.51	23.00
GROUP 15.....	\$ 38.87	23.00
GROUP 16.....	\$ 37.17	23.00
GROUP 17.....	\$ 32.06	23.00
GROUP 18.....	\$ 30.65	23.00

FOOTNOTE:

Paid Holidays: New Year's Day, Memorial Day, Fourth of July, Labor Day, Thanksgiving Day and Christmas Day.

POWER EQUIPMENT OPERATOR CLASSIFICATIONS

GROUP 1: Engineer when operating combination of boom and jib
400' or longer

GROUP 2: Engineer when operating combination of boom and jib
400' or longer on a crane that requires an oiler

GROUP 3: Engineer when operating combination of boom and jib
300' or longer

GROUP 4: Engineer when operating combination of boom and jib
300' or longer on a crane that requires an oiler

GROUP 5: Engineer when operating combination of boom and jib
220' or longer

GROUP 6: Engineer when operating combination of boom and jib
220' or longer on a crane that requires an oiler

GROUP 7: Engineer when operating combination of boom and jib
140' or longer

GROUP 8: Engineer when operating combination of boom and jib
140' or longer on a crane that requires an oiler

GROUP 9: Tower crane & derrick operator (where operator's
work station is 50 ft. or more above first sub-level)

GROUP 10: Tower crane & derrick operator (where operator's
work station is 50 ft. or more above first sub-level) on a
crane that requires an oiler

GROUP 11: Engineer when operating combination of boom and jib
120' or longer

GROUP 12: Engineer when operating combination of boom and jib
120' or longer on a crane that requires an oiler

GROUP 13: Crane operator; job mechanic and 3 drum hoist and
excavator

GROUP 14: Crane operator on a crane that requires an oiler

GROUP 15: Hoisting operator; 2 drum hoist and rubber tired
backhoe

GROUP 16: Forklift and 1 drum hoist

GROUP 17: Compressor or welder operator

GROUP 18: Oiler

ENGI0324-004 06/01/2017

AREA 1: ALLEGAN, BARRY, BERRIEN, BRANCH, CALHOUN, CASS, EATON,
HILLSDALE, IONIA, KALAMAZOO, KENT, LAKE, MANISTEE, MASON,
MECOSTA, MONTCALM, MUSKEGON, NEWAYGO, OCEANA, OSCEOLA, OTTAWA,
ST. JOSEPH, VAN BUREN

AREA 2: ANTRIM, BENZIE, CHARLEVOIX, EMMET, GRAND TRAVERSE,
KALKASKA, LEELANAU, MISSAUKEE AND WEXFORD COUNTIES:

	Rates	Fringes
OPERATOR: Power Equipment (Steel Erection)		
AREA 1		
GROUP 1.....	\$ 44.32	23.00
GROUP 2.....	\$ 41.05	23.00
GROUP 3.....	\$ 39.51	23.00
GROUP 4.....	\$ 37.17	23.00
GROUP 5.....	\$ 32.06	23.00
GROUP 6.....	\$ 30.65	23.00
AREA 2		
GROUP 1.....	\$ 44.32	23.00
GROUP 2.....	\$ 41.05	23.00
GROUP 3.....	\$ 39.51	23.00
GROUP 4.....	\$ 37.17	23.00
GROUP 5.....	\$ 32.06	23.00
GROUP 6.....	\$ 30.65	23.00

FOOTNOTES:

Crane operator with main boom and jib 300' or longer: \$1.50 additional to the group 1 rate. Crane operator with main boom and jib 400' or longer: \$3.00 additional to the group 1 rate.
 PAID HOLIDAYS: New Year's Day, Memorial Day, Fourth of July, Labor Day, Thanksgiving Day and Christmas Day.

POWER EQUIPMENT OPERATOR CLASSIFICATIONS:

- GROUP 1: Crane Operator with main boom & jib 400', 300', or 220' or longer.
- GROUP 2: Crane Operator with main boom & jib 140' or longer, Tower Crane; Gantry Crane; Whirley Derrick.
- GROUP 3: Regular Equipment Operator, Crane, Dozer, Loader, Hoist, Straddle Wagon, Mechanic, Grader and Hydro Excavator.
- GROUP 4: Air Tugger (single drum), Material Hoist Pump 6" or over, Elevators, Brokk Concrete Breaker.
- GROUP 5: Air Compressor, Welder, Generators, Conveyors
- GROUP 6: Oiler and fire tender

 * ENGI0324-005 09/01/2017

AREA 1: GENESEE, LAPEER, LIVINGSTON, MACOMB, MONROE, OAKLAND, ST. CLAIR, WASHTENAW AND WAYNE COUNTIES

AREA 2: ALCONA, ALLEGAN, ALGER, ALPENA, ANTRIM, ARENAC, BARAGA, BARRY, BAY, BENZIE, BERRIEN, BRANCH, CALHOUN, CASS, CHARLEVOIX, CHEBOYGAN, CHIPPEWA, CLARE, CLINTON, CRAWFORD, DELTA, DICKINSON, EATON, EMMET, GLADWIN, GOGEBIC, GRAND TRAVERSE, GRATIOT, HILLSDALE, HOUGHTON, HURON, INGHAM, IONIA, IOSCO, IRON, ISABELLA, JACKSON, KALAMAZOO, KALKASKA, KENT, KWEENAW, LAKE, LEELANAU, LENAWEE, LUCE, MACKINAC, MANISTEE, MARQUETTE, MASON, MECOSTA, MENOMINEE, MIDLAND, MISSAUKEE,

MONTCALM, MONTMORENCY, MUSKEGON, NEWAYGO, OCEANA, OGEMAW,
 ONTONAGON, OSCEOLA, OSCODA, OTSEGO, OTTAWA, PRESQUE ISLE,
 ROSCOMMON, SAGINAW, SANILAC, SCHOOLCRAFT, SHIAWASSEE, ST.
 JOSEPH, TUSCOLA, VAN BUREN AND WEXFORD COUNTIES

	Rates	Fringes
OPERATOR: Power Equipment (Underground construction (including sewer))		
AREA 1:		
GROUP 1.....	\$ 32.03	23.35
GROUP 2.....	\$ 27.30	23.35
GROUP 3.....	\$ 26.57	23.35
GROUP 4.....	\$ 26.00	23.35
AREA 2:		
GROUP 1.....	\$ 30.32	23.35
GROUP 2.....	\$ 25.43	23.35
GROUP 3.....	\$ 24.93	23.35
GROUP 4.....	\$ 24.65	23.35

POWER EQUIPMENT OPERATOR CLASSIFICATIONS

GROUP 1: Backfiller tamper; Backhoe; Batch plant operator (concrete); Clamshell; Concrete paver (2 drums or larger); Conveyor loader (Euclid type); Crane (crawler, truck type or pile driving); Dozer; Dragline; Elevating grader; Endloader; Gradall (and similar type machine); Grader; Mechanic; Power shovel; Roller (asphalt); Scraper (self-propelled or tractor drawn); Side boom tractor (type D-4 or equivalent and larger); Slip form paver; Slope paver; Trencher (over 8 ft. digging capacity); Well drilling rig; Concrete pump with boom operator; Hydro Excavator

GROUP 2: Boom truck (power swing type boom); Crusher; Hoist; Pump (1 or more - 6-in. discharge or larger - gas or diesel- powered or powered by generator of 300 amperes or more - inclusive of generator); Side boom tractor (smaller than type D-4 or equivalent); Tractor (pneu-tired, other than backhoe or front end loader); Trencher (8-ft. digging capacity and smaller); Vac Truck

GROUP 3: Air compressors (600 cfm or larger); Air compressors (2 or more-less than 600 cfm); Boom truck (non-swinging, non- powered type boom); Concrete breaker (self-propelled or truck mounted - includes compressor); Concrete paver (1 drum-1/2 yd. or larger); Elevator (other than passenger); Maintenance person; Pump (2 or more-4-in. up to 6-in. discharge-gas or diesel powered - excluding submersible pumps); Pumpcrete machine (and similar equipment); Wagon drill (multiple); Welding machine or generator (2 or more-300 amp. or larger - gas or diesel powered)

GROUP 4: Boiler; Concrete saw (40 hp or over); Curing machine (self-propelled); Farm tractor (with attachment); Finishing machine (concrete); Fire person; Hydraulic pipe pushing machine; Mulching equipment; Oiler; Pumps (2 or more up to 4-in. discharge, if used 3 hours or more a day, gas or diesel powered - excluding submersible pumps); Roller (other than asphalt); Stump remover; Trencher (service);

Vibrating compaction equipment, self-propelled (6 ft. wide or over); End dump operator; Sweeper (Wayne type); Water wagon and Extend-a boom forklift

 ENGI0324-006 06/01/2016

AREA 1: GENESEE, MACOMB, MONROE, OAKLAND, WASHTENAW AND WAYNE COUNTIES

AREA 2: ALCONA, ALGER, ALLEGAN, ALPENA, ANTRIM, ARENAC, BARAGA, BARRY, BAY, BENZIE, BERRIEN, BRANCH, CALHOUN, CASS, CHARLEVOIX, CHEBOYGAN, CHIPPEWA, CLARE, CLINTON, CRAWFORD, DELTA, DICKINSON, EATON, EMMET, GLADWIN, GOGEBIC, GRAND TRAVERSE, GRATIOT, HILLSDALE, HOUGHTON, HURON, INGHAM, IONIA, IOSCO, IRON, ISABELLA, JACKSON, KALAMAZOO, KALKASKA, KENT, KEWEENAW, LAKE, LAPEER, LEELANAU, LENAWEE, LIVINGSTON, LUCE, MACKINAC, MANISTEE, MARQUETTE, MASON, MECOSTA, MENOMINEE, MIDLAND, MISSAUKEE, MONTCALM, MONTMORENCY, MUSKEGON, NEWAYGO, OCEANA, OGEMAW, ONTONAGON, OSCEOLA, OSCODA, OTSEGO, OTTAWA, PRESQUE ISLE, ROSCOMMON, SAGINAW, ST. CLARE, ST. JOSEPH, SANILAC, SCHOOLCRAFT, SHIAWASSEE, TUSCOLA, VAN BUREN AND WEXFORD COUNTIES

	Rates	Fringes
Power equipment operators: (AIRPORT, BRIDGE & HIGHWAY CONSTRUCTION)		
AREA 1		
GROUP 1.....	\$ 31.66	22.85
GROUP 2.....	\$ 24.93	22.85
GROUP 3.....	\$ 26.23	22.85
GROUP 4.....	\$ 24.37	22.85
GROUP 5.....	\$ 24.20	22.85
AREA 2		
GROUP 1.....	\$ 31.66	22.85
GROUP 2.....	\$ 24.78	22.85
GROUP 3.....	\$ 26.08	22.85
GROUP 4.....	\$ 24.22	22.85
GROUP 5.....	\$ 23.90	22.85

POWER EQUIPMENT OPERATOR CLASSIFICATIONS

GROUP 1: Asphalt plant operator; Crane operator (does not include work on bridge construction projects when the crane operator is erecting structural components); Dragline operator; Shovel operator; Locomotive operator; Paver operator (5 bags or more); Elevating grader operator; Pile driving operator; Roller operator (asphalt); Blade grader operator; Trenching machine operator (ladder or wheel type); Auto-grader; Slip form paver; Self-propelled or tractor-drawn scraper; Conveyor loader operator (Euclid type); Endloader operator (1 yd. capacity and over); Bulldozer; Hoisting engineer; Tractor operator; Finishing machine operator (asphalt); Mechanic; Pump operator (6-in. discharge or over, gas, diesel powered or generator of 300 amp. or larger); Shouldering or gravel distributing machine operator (self-propelled); Backhoe (with over 3/8 yd. bucket); Side boom tractor (type D-4 or equivalent or larger); Tube finisher (slip form paving); Gradall (and similar type machine); Asphalt paver (self-propelled); Asphalt planer (self-propelled); Batch plant

(concrete-central mix); Slurry machine (asphalt); Concrete pump (3 in. and over); Roto-mill; Swinging boom truck (over 12 ton capacity); Hydro demolisher (water blaster); Farm-type tractor with attached pan

GROUP 2: Screening plant operator; Washing plant operator; Crusher operator; Backhoe (with 3/8 yd. bucket or less); Side boom tractor (smaller than D-4 type or equivalent); Sweeper (Wayne type and similar equipment); Vacuum truck operator; Batch plant (concrete dry batch)

GROUP 3: Grease Truck

GROUP 4: Air compressor operator (600 cu. ft. per min or more); Air compressor operator (two or more, less than 600 cfm); Wagon drill operator; Concrete breaker; Tractor operator (farm type with attachment)

GROUP 5: Boiler fire tender; Oiler; Fire tender; Trencher (service); Flexplane operator; Cleftplane operator; Grader operator (self-propelled fine-grade or form (concrete)); Finishing machine operator (concrete); Boom or winch hoist truck operator; Endloader operator (under 1 yd. capacity); Roller operator (other than asphalt); Curing equipment operator (self-propelled); Concrete saw operator (40 h.p. or over); Power bin operator; Plant drier operator (asphalt); Vibratory compaction equipment operator (6 ft. wide or over); Guard post driver operator (power driven); All mulching equipment; Stump remover; Concrete pump (under 3-in.); Mesh installer (self-propelled); Tractor operator (farm type); End dump; Skid steer

 ENGI0324-007 05/01/2016

ALGER, BARAGA, CHIPPEWA, DELTA, DICKINSON, GOGEBIC, HOUGHTON, IRON, KEWEENAW, LUCE, MACKINAC MARQUETTE, MENOMINEE, ONTONAGON AND SCHOOLCRAFT COUNTIES:

	Rates	Fringes
OPERATOR: Power Equipment		
(Steel Erection)		
Compressor, welder and forklift.....	\$ 25.46	22.55
Crane operator, main boom & jib 120' or longer.....	\$ 29.21	22.55
Crane operator, main boom & jib 140' or longer.....	\$ 29.46	22.55
Crane operator, main boom & jib 220' or longer.....	\$ 29.71	22.55
Mechanic with truck and tools.....	\$ 30.21	22.55
Oiler and fireman.....	\$ 24.16	22.55
Regular operator.....	\$ 28.71	22.55

 ENGI0324-008 10/01/2015

ALCONA, ALGER, ALLEGAN, ALPENA, ANTRIM, ARENAC, BARAGA, BARRY, BAY, BENZIE, BERRIEN, BRANCH, CALHOUN, CASS, CHARLEVOIX, CHEBOYGAN, CHIPPEWA, CLARE, CLINTON, CRAWFORD, DELTA,

DICKINSON, EATON, EMMET, GENESEE, GLADWIN, GOGEBIC, GRAND TRVERSE, GRATIOT, HILLSDALE, HOUGHTON, HURON, INGHAM, IONIA, IOSCO, IRON, ISABELLA, JACKSON, KALAMAZOO, KALKASKA, KENT, KEWEENAW, LAKE, LAPEER, LEELANAU, LENAWEE, LIVINGSTON, LUCE, MACKINAC, MACOMB, MANISTEE, MARQUETTE, MASON, MECOSTA, MENOMINEE, MIDLAND, MISSAUKEE, MONTCALM, MONTMORENCY, MONROE, MUSKEGON, NEWAYGO, OAKLAND, OCEANA, OGEMAW, ONTONAGON, OSCEOLA, OSCODA, OTSEGO, OTTAWA, PRESQUE ISLE, ROSCOMMON, SAGINAW, ST. CLARE, ST. JOSEPH, SANILAC, SCHOOLCRAFT, SHIAWASSEE, TUSCOLA, VAN BUREN, WASHTENAW, WAYNE AND WEXFORD COUNTIES

	Rates	Fringes
OPERATOR: Power Equipment (Sewer Relining)		
GROUP 1.....	\$ 30.70	12.93
GROUP 2.....	\$ 29.17	12.93

SEWER RELINING CLASSIFICATIONS

GROUP 1: Operation of audio-visual closed circuit TV system, including remote in-ground cutter and other equipment used in connection with the CCTV system

GROUP 2: Operation of hot water heaters and circulation systems, water jetters and vacuum and mechanical debris removal systems

ENGI0325-012 05/01/2017

AREA 1: MACOMB, MONROE, OAKLAND, ST. CLAIR, WASHTENAW AND WAYNE COUNTIES

AREA 2: ALCONA, ALGER, ALLEGAN, ALPENA, ANTRIM, ARENAC, BARAGA, BARRY, BAY, BENZIE, BERRIEN, BRANCH, CALHOUN, CASS, CHARLEVOIX, CHEBOYGAN, CHIPPEWA, CLARE, CLINTON, CRAWFORD, DELTA, DICKINSON, EATON, EMMET, GENESEE, GLADWIN, GOGEBIC, GRAND TRVERSE, GRATIOT, HILLSDALE, HOUGHTON, HURON, INGHAM, IONIA, IOSCO, IRON, ISABELLA, JACKSON, KALAMAZOO, KALKASKA, KENT, KEWEENAW, LAKE, LAPEER, LEELANAU, LENAWEE, LIVINGSTON LUCE, MACKINAC, MANISTEE, MARQUETTE, MASON, MECOSTA, MENOMINEE, MIDLAND, MISSAUKEE, MONTCALM, MONTMORENCY, MUSKEGON, NEWAYGO, OCEANA, OGEMAW, ONTONAGON, OSCEOLA, OSCODA, OTSEGO, OTTAWA, PRESQUE ISLE, ROSCOMMON, SAGINAW, ST. JOSEPH, SANILAC, SCHOOLCRAFT, SHIAWASSEE, TUSCOLA, VAN BUREN AND WEXFORD COUNTIES

	Rates	Fringes
Power equipment operators - gas distribution and duct installation work:		
AREA 1		
GROUP 1.....	\$ 29.73	23.30
GROUP 2.....	\$ 29.60	23.30
GROUP 3.....	\$ 28.48	23.30
GROUP 4.....	\$ 27.90	23.30
AREA 2		
GROUP 1.....	\$ 28.82	23.30
GROUP 2-A.....	\$ 28.72	23.30

GROUP 2-B.....	\$ 28.50	23.30
GROUP 3.....	\$ 27.72	23.30
GROUP 4.....	\$ 27.22	23.30

SCOPE OF WORK: The construction, installation, treating and reconditioning of pipelines transporting gas vapors within cities, towns, subdivisions, suburban areas, or within private property boundaries, up to and including private meter settings of private industrial, governmental or other premises, more commonly referred to as "distribution work," starting from the first metering station, connection, similar or related facility, of the main or cross country pipeline and including duct installation.

AREA 1:

- GROUP 1: Backhoe, crane, grader, mechanic, dozer (D-6 equivalent or larger), side boom (D-4 equivalent or larger), trencher(except service), endloader (2 yd. capacity or greater).
- GROUP 2: Dozer (less than D-6 equivalent), endloader (under 2 yd. capacity), side boom (under D-4 capacity), backfiller, pumps (1 or 2 of 6-inch discharge or greater), boom truck (with powered boom), tractor (wheel type other than backhoe or front endloader).
- GROUP 3: Tamper (self-propelled), boom truck (with non-powered boom), concrete saw (20 hp or larger), pumps (2 to 4 under 6-inch discharge), compressor (2 or more or when one is used continuously into the second day) and trencher(service).
- GROUP 4: Oiler, hydraulic pipe pushing machine, grease person and hydrostatic testing operator.

AREA 2:

- GROUP 1: Mechanic, crane (over 1/2 yd. capacity), backhoe (over 1/2 yd. capacity), grader (Caterpillar 12 equivalent or larger)
- GROUP 2-A: Trencher(except service), backhoe (1/2 yd. capacity or less)
- GROUP 2-B: Crane (1/2 yd. capacity or less), compressor (2 or more), dozer (D-4 equivalent or larger), endloader (1 yd. capacity or larger), pump (1 or 2 six-inch or larger), side boom (D-4 equivalent or larger)
- GROUP 3: Backfiller, boom truck (powered), concrete saw (20 hp or larger), dozer (less than D-4 equivalent), endloader (under 1 yd. capacity), farm tractor (with attachments), pump (2 - 4 under six-inch capacity), side boom tractor(less than D-4 equivalent), tamper (self-propelled), trencher service and grader maintenance
- GROUP 4: Oiler, grease person and hydrostatic testing operator

ALGER, BARAGA, CHIPPEWA, DELTA, DICKINSON, GOGEBIC, HOUGHTON,
 IRON, KEWEENAW, LUCE, MACKINAC MARQUETTE, MENOMINEE, ONTONAGON
 AND SCHOOLCRAFT COUNTIES:

	Rates	Fringes
Ironworker - pre-engineered metal building erector.....	\$ 23.70	6.95
IRONWORKER		
General contracts		
\$10,000,000 or greater.....	\$ 26.52	24.35
General contracts less		
than \$10,000,000.....	\$ 23.11	24.35

Paid Holidays: New Year's Day, Memorial Day, July 4th, Labor
 Day, Thanksgiving Day & Christmas Day.

 IRON0025-002 06/01/2015

ALCONA, ALPENA, ARENAC, BAY, CHEBOYGAN, CLARE, CLINTON,
 CRAWFORD, GENESEE, GLADWIN, GRATIOT, HURON, INGHAM, IOSCO,
 ISABELLA, JACKSON, LAPEER, LIVINGSTON, MACOMB, MIDLAND,
 MONTMORENCY, OAKLAND, OGEMAW, OSCODA, OTSEGO, PRESQUE ISLE,
 ROSCOMMON, SAGINAW, SANILAC, SHIAWASSEE, ST. CLAIR, TUSCOLA,
 WASHTENAW AND WAYNE COUNTIES:

	Rates	Fringes
Ironworker - pre-engineered metal building erector		
Alcona, Alpena, Arenac, Cheboygan, Clare, Clinton, Crawford, Gladwin, Gratiot, Huron, Ingham, Iosco, Isabella, Jackson, Lapeer, Livingston (west of Burkhardt Road), Montmorency, Ogemaw, Oscoda, Otsego, Presque Isle, Roscommon, Sanilac, Shiawassee, Tuscola & Washtenaw (west of U.S. 23).	\$ 22.17	20.13
Bay, Genesee, Lapeer, Livingston (east of Burkhardt Road), Macomb, Midland, Oakland, Saginaw, St. Clair, The University of Michigan, Washtenaw (east of U.S. 23) & Wayne...	\$ 23.39	21.13
IRONWORKER		
Ornamental and Structural...	\$ 33.78	27.84
Reinforcing.....	\$ 28.30	24.60

 IRON0055-005 07/01/2013

LENAWEE AND MONROE COUNTIES:

Rates	Fringes
-------	---------

IRONWORKER

Pre-engineered metal buildings.....	\$ 23.59	19.35
All other work.....	\$ 28.32	19.35

IRON0292-003 06/01/2016

BERRIEN AND CASS COUNTIES:

	Rates	Fringes
IRONWORKER (Including pre-engineered metal building erector).....	\$ 28.81	20.16

IRON0340-001 06/01/2015

ALLEGAN, ANTRIM, BARRY, BENZIE, BRANCH, CALHOUN, CHARLEVOIX, EATON, EMMET, GRAND TRAVERSE, HILLSDALE, IONIA, KALAMAZOO, KALKASKA, KENT, LAKE, LEELANAU, MANISTEE, MASON, MECOSTA, MISSAUKEE, MONTCALM, MUSKEGON, NEWAYGO, OCEANA, OSCEOLA, OTTAWA, ST. JOSEPH, VAN BUREN AND WEXFORD COUNTIES:

	Rates	Fringes
IRONWORKER (Including pre-engineered metal building erector).....	\$ 21.68	24.37

LABO0005-006 10/01/2014

	Rates	Fringes
Laborers - hazardous waste abatement: (ALCONA, ALPENA, ANTRIM, BENZIE, CHARLEVOIX, CHEBOYGAN, CRAWFORD, EMMET, GRAND TRAVERSE, IOSCO, KALKASKA, LEELANAU, MISSAUKEE, MONTMORENCY, OSCODA, OTSEGO, PRESQUE ISLE AND WEXFORD COUNTIES - Zone 10) Levels A, B or C.....	\$ 17.45	12.75
Work performed in conjunction with site preparation not requiring the use of personal protective equipment; Also, Level D.....	\$ 16.45	12.75
Laborers - hazardous waste abatement: (ALGER, BARAGA, CHIPPEWA, DELTA, DICKINSON, GOGEBIC, HOUGHTON, IRON, KEWEENAW, LUCE, MACKINAC, MARQUETTE, MENOMINEE, ONTONAGON AND SCHOOLCRAFT COUNTIES - Zone 11) Levels A, B or C.....	\$ 20.91	12.78
Work performed in conjunction with site		

preparation not requiring the use of personal protective equipment; Also, Level D.....\$ 19.91	12.78
Laborers - hazardous waste abatement: (ALLEGAN, BARRY, BERRIEN, BRANCH, CALHOUN, CASS, IONIA COUNTY (except the city of Portland); KALAMAZOO, KENT, LAKE, MANISTEE, MASON, MECOSTA, MONTCALM, MUSKEGON, NEWAYGO, OCEANA, OSCEOLA, OTTAWA, ST. JOSEPH AND VAN BUREN COUNTIES - Zone 9)	
Levels A, B or C.....\$ 19.99	12.75
Work performed in conjunction with site preparation not requiring the use of personal protective equipment; Also, Level D.....\$ 18.99	12.75
Laborers - hazardous waste abatement: (ARENAC, BAY, CLARE, GLADWIN, GRATIOT, HURON, ISABELLA, MIDLAND, OGEMAW, ROSCOMMON, SAGINAW AND TUSCOLA COUNTIES - Zone 8)	
Levels A, B or C.....\$ 20.02	12.75
Work performed in conjunction with site preparation not requiring the use of personal protective equipment; Also, Level D.....\$ 19.02	12.75
Laborers - hazardous waste abatement: (CLINTON, EATON AND INGHAM COUNTIES; IONIA COUNTY (City of Portland); LIVINGSTON COUNTY (west of Oak Grove Rd., including the City of Howell) - Zone 6)	
Levels A, B or C.....\$ 23.29	12.75
Work performed in conjunction with site preparation not requiring the use of personal protective equipment; Also, Level D.....\$ 22.29	12.75
Laborers - hazardous waste abatement: (GENESEE, LAPEER AND SHIAWASSEE COUNTIES - Zone 7)	
Levels A, B or C.....\$ 23.40	12.79
Work performed in conjunction with site preparation not requiring the use of personal protective equipment; Also, Level D.....\$ 22.40	12.79
Laborers - hazardous waste abatement: (HILLSDALE,	

JACKSON AND LENAWEЕ COUNTIES

- Zone 4)

Levels A, B or C.....\$ 30.00 14.09
 Work performed in
 conjunction with site
 preparation not requiring
 the use of personal
 protective equipment;
 Also, Level D.....\$ 29.00 14.09

Laborers - hazardous waste
 abatement: (LIVINGSTON COUNTY
 (east of Oak Grove Rd. and
 south of M-59, excluding the
 city of Howell); AND

WASHTENAW COUNTY - Zone 3)

Levels A, B or C.....\$ 29.32 13.85
 Work performed in
 conjunction with site
 preparation not requiring
 the use of personal
 protective equipment;
 Also, Level D.....\$ 28.32 13.85

Laborers - hazardous waste
 abatement: (MACOMB AND WAYNE
 COUNTIES - Zone 1)

Levels A, B or C.....\$ 27.94 16.55
 Work performed in
 conjunction with site
 preparation not requiring
 the use of personal
 protective equipment;
 Also, Level D.....\$ 26.94 16.55

Laborers - hazardous waste
 abatement: (MONROE COUNTY -
 Zone 4)

Levels A, B or C.....\$ 30.00 14.09
 Work performed in
 conjunction with site
 preparation not requiring
 the use of personal
 protective equipment;
 Also, Level D.....\$ 29.00 14.09

Laborers - hazardous waste
 abatement: (OAKLAND COUNTY
 and the Northeast portion of
 LIVINGSTON COUNTY bordered by
 Oak Grove Road on the West
 and M-59 on the South - Zone
 2)

Level A, B, C.....\$ 27.94 16.55
 Work performed in
 conjunction with site
 preparation not requiring
 the use of personal
 protective equipment;
 Also, Level D.....\$ 26.94 16.55

Laborers - hazardous waste
 abatement: (SANILAC AND ST.
 CLAIR COUNTIES - Zone 5)

Levels A, B or C.....\$ 24.97 15.19
 Work performed in
 conjunction with site

preparation not requiring
the use of personal
protective equipment;

Also, Level D.....\$ 23.97 15.19

LABO0259-001 09/01/2016

AREA 1: MACOMB, OAKLAND AND WAYNE COUNTIES
AREA 2: ALCONA, ALGER, ALLEGAN, ALPENA, ANTRIM, ARENAC, BARAGA,
BARRY, BAY, BENZIE, BERRIEN, BRANCH, CALHOUN, CASS, CHARLEVOIX,
CHEBOYGAN, CHIPPEWA, CLARE, CLINTON, CRAWFORD, DELTA,
DICKINSON, EATON, EMMET, GENESEE, GLADWIN, GOGEBIC, GRAND
TRAVERSE, GRATIOT, HILLSDALE, HOUGHTON, HURON, INGHAM, IONIA,
IOSCO, IRON, ISABELLA, JACKSON, KALAMAZOO, KALKASKA, KENT,
KEWEENAW, LAKE, LAPEER, LEELANAU, LENAWEE, LIVINGSTON, LUCE,
MACKINAC, MANISTEE, MARQUETTE, MASON, MECOSTA, MENOMINEE,
MIDLAND, MISSAUKEE, MONROE, MONTCALM, MONTMORENCY, MUSKEGON,
NEWAYGO, OCEANA, OGEMAW, ONTONAGON, OSCEOLA, OSCODA, OTSEGO,
OTTAWA, PRESQUE ISLE, ROSCOMMON, SAGINAW, ST. CLARE, ST.
JOSEPH, SANILAC, SCHOOLCRAFT, SHIAWASSEE, TUSCOLA, VAN BUREN,
WASHTENAW AND WEXFORD COUNTIES

	Rates	Fringes
Laborers - tunnel, shaft and caisson:		
AREA 1		
GROUP 1.....	\$ 21.87	16.70
GROUP 2.....	\$ 21.98	16.70
GROUP 3.....	\$ 22.04	16.70
GROUP 4.....	\$ 22.22	16.70
GROUP 5.....	\$ 22.47	16.70
GROUP 6.....	\$ 22.80	16.70
GROUP 7.....	\$ 16.08	16.70
AREA 2		
GROUP 1.....	\$ 23.35	12.85
GROUP 2.....	\$ 23.44	12.85
GROUP 3.....	\$ 23.54	12.85
GROUP 4.....	\$ 23.70	12.85
GROUP 5.....	\$ 23.96	12.85
GROUP 6.....	\$ 24.27	12.85
GROUP 7.....	\$ 16.54	12.88

SCOPE OF WORK: Tunnel, shaft and caisson work of every type
and description and all operations incidental thereto,
including, but not limited to, shafts and tunnels for
sewers, water, subways, transportation, diversion,
sewerage, caverns, shelters, aquifers, reservoirs, missile
silos and steel sheeting for underground construction.

TUNNEL LABORER CLASSIFICATIONS

GROUP 1: Tunnel, shaft and caisson laborer, dump, shanty, hog
house tender, testing (on gas) and watchman

GROUP 2: Manhole, headwall, catch basin builder, bricklayer
tender, mortar machine and material mixer

GROUP 3: Air tool operator (jackhammer, bush hammer and
grinder), first bottom, second bottom, cage tender, car
pusher, carrier, concrete, concrete form, concrete repair,

cement invert laborer, cement finisher, concrete shoveler, conveyor, floor, gasoline and electric tool operator, gunite, grout operator, welder, heading dinky person, inside lock tender, pea gravel operator, pump, outside lock tender, scaffold, top signal person, switch person, track, tugger, utility person, vibrator, winch operator, pipe jacking, wagon drill and air track operator and concrete saw operator (under 40 h.p.)

GROUP 4: Tunnel, shaft and caisson mucker, bracer, liner plate, long haul dinky driver and well point

GROUP 5: Tunnel, shaft and caisson miner, drill runner, key board operator, power knife operator, reinforced steel or mesh (e.g. wire mesh, steel mats, dowel bars, etc.)

GROUP 6: Dynamite and powder

GROUP 7: Restoration laborer, seeding, sodding, planting, cutting, mulching and top soil grading; and the restoration of property such as replacing mailboxes, wood chips, planter boxes, flagstones, etc.

LABO0334-001 09/01/2016

	Rates	Fringes
Laborers - open cut:		
ZONE 1 - MACOMB, OAKLAND AND WAYNE COUNTIES:		
GROUP 1.....	\$ 21.72	16.70
GROUP 2.....	\$ 21.83	16.70
GROUP 3.....	\$ 21.85	16.70
GROUP 4.....	\$ 21.96	16.70
GROUP 5.....	\$ 22.02	16.70
GROUP 6.....	\$ 19.47	16.70
GROUP 7.....	\$ 16.09	16.70
ZONE 2 - LIVINGSTON COUNTY (east of M-151 (Oak Grove Rd.)); MONROE AND WASHTENAW COUNTIES:		
GROUP 1.....	\$ 23.00	12.85
GROUP 2.....	\$ 23.11	12.85
GROUP 3.....	\$ 23.23	12.85
GROUP 4.....	\$ 23.30	12.85
GROUP 5.....	\$ 23.45	12.85
GROUP 6.....	\$ 20.75	12.85
GROUP 7.....	\$ 17.39	12.85
ZONE 3 - CLINTON, EATON, GENESEE, HILLSDALE AND INGHAM COUNTIES; IONIA COUNTY (City of Portland); JACKSON, LAPEER AND LENAWEE COUNTIES; LIVINGSTON COUNTY (west of M-151 Oak Grove Rd.); SANILAC, ST. CLAIR AND SHIAWASSEE COUNTIES:		
GROUP 1.....	\$ 21.19	12.85
GROUP 2.....	\$ 21.33	12.85
GROUP 3.....	\$ 21.45	12.85

GROUP 4.....	\$ 21.50	12.85
GROUP 5.....	\$ 21.64	12.85
GROUP 6.....	\$ 18.94	12.85
GROUP 7.....	\$ 16.09	12.85
ZONE 4 - ALCONA, ALLEGAN, ALPENA, ANTRIM, ARENAC, BARRY, BAY, BENZIE, BERRIEN, BRANCH, CALHOUN, CASS, CHARLEVOIX, CHEBOYGAN, CLARE, CRAWFORD, EMMET, GLADWIN, GRAND TRAVERSE, GRATIOT AND HURON COUNTIES; IONIA COUNTY (EXCEPT THE CITY OF PORTLAND); IOSCO, ISABELLA, KALAMAZOO, KALKASKA, KENT, LAKE, LEELANAU, MANISTEE, MASON, MECOSTA, MIDLAND, MISSAUKEE, MONTCALM, MONTMORENCY, MUSKEGON, NEWAYGO, OCEANA, OGEMAW, OSCEOLA, OSCODA, OTSEGO, OTTAWA, PRESQUE ISLE, ROSCOMMON, SAGINAW, ST. JOSEPH, TUSCOLA, VAN BUREN AND WEXFORD COUNTIES:		
GROUP 1.....	\$ 20.20	12.85
GROUP 2.....	\$ 20.33	12.85
GROUP 3.....	\$ 20.44	12.85
GROUP 4.....	\$ 20.51	12.85
GROUP 5.....	\$ 20.63	12.85
GROUP 6.....	\$ 17.85	12.85
GROUP 7.....	\$ 16.19	12.85
ZONE 5 - ALGER, BARAGA, CHIPPEWA, DELTA, DICKINSON, GOGEBIC, HOUGHTON, IRON, KEWEENAW, LUCE, MACKINAC, MARQUETTE, MENOMINEE, ONTONAGON AND SCHOOLCRAFT COUNTIES:		
GROUP 1.....	\$ 20.51	12.85
GROUP 2.....	\$ 20.65	12.85
GROUP 3.....	\$ 20.78	12.85
GROUP 4.....	\$ 20.83	12.85
GROUP 5.....	\$ 20.88	12.85
GROUP 6.....	\$ 18.26	12.85
GROUP 7.....	\$ 16.37	12.85

SCOPE OF WORK:

Open cut construction work shall be construed to mean work which requires the excavation of earth including industrial, commercial and residential building site excavation and preparation, land balancing, demolition and removal of concrete and underground appurtenances, grading, paving, sewers, utilities and improvements; retention, oxidation, flocculation and irrigation facilities, and also including but not limited to underground piping, conduits, steel sheeting for underground construction, and all work

incidental thereto, and general excavation. For all areas except the Upper Peninsula, open cut construction work shall also be construed to mean waterfront work, piers, docks, seawalls, breakwalls, marinas and all incidental work. Open cut construction work shall not include any structural modifications, alterations, additions and repairs to buildings, or highway work, including roads, streets, bridge construction and parking lots or steel erection work and excavation for the building itself and back filling inside of and within 5 ft. of the building and foundations, footings and piers for the building. Open cut construction work shall not include any work covered under Tunnel, Shaft and Caisson work.

OPEN CUT LABORER CLASSIFICATIONS

GROUP 1: Construction laborer

GROUP 2: Mortar and material mixer, concrete form person, signal person, well point person, manhole, headwall and catch basin builder, headwall, seawall, breakwall and dock builder

GROUP 3: Air, gasoline and electric tool operator, vibrator operator, driller, pump person, tar kettle operator, bracer, rodder, reinforced steel or mesh person (e.g., wire mesh, steel mats, dowel bars, etc.), welder, pipe jacking and boring person, wagon drill and air track operator and concrete saw operator (under 40 h.p.), windlass and tugger person and directional boring person

GROUP 4: Trench or excavating grade person

GROUP 5: Pipe layer (including crock, metal pipe, multi-plate or other conduits)

GROUP 6: Grouting man, audio-visual television operations and all other operations in connection with closed circuit television inspection, pipe cleaning and pipe relining work and the installation and repair of water service pipe and appurtenances

GROUP 7: Restoration laborer, seeding, sodding, planting, cutting, mulching and top soil grading; and the restoration of property such as replacing mailboxes, wood chips, planter boxes, flagstones, etc.

LABO0465-001 06/01/2017

LABORER: Highway, Bridge and Airport Construction

AREA 1: GENESEE, MACOMB, MONROE, OAKLAND, WASHTENAW AND WAYNE COUNTIES

AREA 2: ALLEGAN, BARRY, BAY, BERRIEN, BRANCH, CALHOUN, CASS, CLINTON, EATON, GRATIOT, HILLSDALE, HURON, INGHAM, JACKSON, KALAMAZOO, LAPEER, LENAWEE, LIVINGSTON, MIDLAND, MUSKEGON, SAGINAW, SANILAC, SHIAWASSEE, ST. CLAIR, ST. JOSEPH, TUSCOLA AND VAN BUREN COUNTIES

AREA 3: ALCONA, ALPENA, ANTRIM, ARENAC, BENZIE, CHARLEVOIX,

CHEBOYGAN, CLARE, CRAWFORD, EMMET, GLADWIN, GRAND TRAVERSE,
 IONIA, IOSCO, ISABELLA, KALKASKA, KENT, LAKE, LEELANAU,
 MANISTEE, MASON, MECOSTA, MISSAUKEE, MONTCALM, MONTMORENCY,
 NEWAYGO, OCEANA, OGEMAW, OSCEOLA, OSCODA, OTSEGO, OTTAWA,
 PRESQUE ISLE, ROSCOMMON AND WEXFORD COUNTIES

AREA 4: ALGER, BARAGA, CHIPPEWA, DELTA, DICKINSON, GOGEBIC,
 HOUGHTON, IRON, KEWEENAW, LUCE, MACKINAC, MARQUETTE, MENOMINEE,
 ONTONAGON AND SCHOOLCRAFT COUNTIES

	Rates	Fringes
LABORER (AREA 1)		
GROUP 1.....	\$ 25.74	12.85
GROUP 2.....	\$ 25.87	12.85
GROUP 3.....	\$ 26.05	12.85
GROUP 4.....	\$ 26.13	12.85
GROUP 5.....	\$ 26.34	12.85
GROUP 6.....	\$ 26.64	12.85
LABORER (AREA 2)		
GROUP 1.....	\$ 23.67	12.85
GROUP 2.....	\$ 23.87	12.85
GROUP 3.....	\$ 24.11	12.85
GROUP 4.....	\$ 24.46	12.85
GROUP 5.....	\$ 24.33	12.85
GROUP 6.....	\$ 24.67	12.85
LABORER (AREA 3)		
GROUP 1.....	\$ 22.92	12.85
GROUP 2.....	\$ 23.13	12.85
GROUP 3.....	\$ 23.42	12.85
GROUP 4.....	\$ 23.86	12.85
GROUP 5.....	\$ 23.48	12.85
GROUP 6.....	\$ 23.91	12.85
LABORER (AREA 4)		
GROUP 1.....	\$ 22.94	12.85
GROUP 2.....	\$ 23.15	12.85
GROUP 3.....	\$ 23.44	12.85
GROUP 4.....	\$ 23.88	12.85
GROUP 5.....	\$ 23.50	12.85
GROUP 6.....	\$ 23.93	12.85

LABORER CLASSIFICATIONS

GROUP 1: Asphalt shoveler or loader; asphalt plant misc.;
 burlap person; yard person; dumper (wagon, truck, etc.);
 joint filling laborer; miscellaneous laborer; unskilled
 laborer; sprinkler laborer; form setting laborer; form
 stripper; pavement reinforcing; handling and placing (e.g.,
 wire mesh, steel mats, dowel bars); mason's tender or
 bricklayer's tender on manholes; manhole builder;
 headwalls, etc.; waterproofing, (other than buildings) seal
 coating and slurry mix, shoring, underpinning; pressure
 grouting; bridge pin and hanger removal; material recycling
 laborer; horizontal paver laborer (brick, concrete, clay,
 stone and asphalt); ground stabilization and modification
 laborer; grouting; waterblasting; top person; railroad
 track and trestle laborer; carpenters' tender; guard rail
 builders' tender; earth retention barrier and wall and
 M.S.E. wall installer's tender; highway and median
 installer's tender (including sound, retaining, and crash
 barriers); fence erector's tender; asphalt raker tender;

sign installer; remote control operated equipment.

GROUP 2: Mixer operator (less than 5 sacks); air or electric tool operator (jackhammer, etc.); spreader; boxperson (asphalt, stone, gravel); concrete paddler; power chain saw operator; paving batch truck dumper; tunnel mucker (highway work only); concrete saw (under 40 h.p.) and dry pack machine; roto-mill grounds person.

GROUP 3: Tunnel miner (highway work only); finishers tenders; guard rail builders; highway and median barrier installer; earth retention barrier and wall and M.S.E. wall installer's (including sound, retaining and crash barriers); fence erector; bottom person; powder person; wagon drill and air track operator; diamond and core drills; grade checker; certified welders; curb and side rail setter's tender.

GROUP 4: Asphalt raker

GROUP 5: Pipe layers, oxy-gun

GROUP 6: Line-form setter for curb or pavement; asphalt screed checker/screw man on asphalt paving machines.

LABO1076-005 04/01/2017

MICHIGAN STATEWIDE

	Rates	Fringes
LABORER (DISTRIBUTION WORK)		
Zone 1.....	\$ 19.99	12.85
Zone 2.....	\$ 18.35	12.85
Zone 3.....	\$ 16.56	12.85
Zone 4.....	\$ 15.92	12.85
Zone 5.....	\$ 15.92	12.85

DISTRIBUTION WORK - The construction, installation, treating and reconditioning of distribution pipelines transporting coal, oil, gas or other similar materials, vapors or liquids, including pipelines within private property boundaries, up to and including the meter settings on residential, commercial, industrial, institutional, private and public structures. All work covering pumping stations and tank farms not covered by the Building Trades Agreement. Other distribution lines with the exception of sewer, water and cable television are included.

Underground Duct Layer Pay: \$.40 per hour above the base pay rate.

- Zone 1 - Macomb, Oakland and Wayne
- Zone 2 - Monroe and Washtenaw
- Zone 3 - Bay, Genesee, Lapeer, Midland, Saginaw, Sanilac, Shiawassee and St. Clair
- Zone 4 - Alger, Baraga, Chippewa, Delta, Dickinson, Gogebic, Houghton, Iron, Keweenaw, Luce, Mackinac, Marquette, Menominee, Ontonagon and Schoolcraft
- Zone 5 - Remaining Counties in Michigan

PAIN0022-002 07/01/2008

HILLSDALE, JACKSON AND LENAWEE COUNTIES; LIVINGSTON COUNTY
(east of the eastern city limits of Howell, not including the
city of Howell, north to the Genesee County line and south to
the Washtenaw County line); MACOMB, MONROE, OAKLAND, WASHTENAW
AND WAYNE COUNTIES:

	Rates	Fringes
PAINTER.....	\$ 25.06	14.75

FOOTNOTES: For all spray work and journeyman rigging for
spray work, also blowing off, \$0.80 per hour additional
(applies only to workers doing rigging for spray work on
off the floor work. Does not include setting up or moving
rigging on floor surfaces, nor does it apply to workers
engaged in covering up or tending spray equipment. For all
sandblasting and spray work performed on highway bridges,
overpasses, tanks or steel, \$0.80 per hour additional. For
all brushing, cleaning and other preparatory work (other
than spraying or steeplejack work) at scaffold heights of
fifty (50) feet from the ground or higher, \$0.50 per hour
additional. For all preparatorial work and painting
performed on open steel under forty (40) feet when no
scaffolding is involved, \$0.50 per hour additional. For all
swing stage work-window jacks and window belts-exterior and
interior, \$0.50 per hour additional. For all spray work and
sandblaster work to a scaffold height of forty (40) feet
above the floor level, \$0.80 per hour additional. For all
preparatorial work and painting on all highway bridges or
overpasses up to forty (40) feet in height, \$0.50 per hour
additional. For all steeplejack work performed where the
elevation is forty (40) feet or more, \$1.25 per hour
additional.

PAIN0312-001 06/12/2014

EXCLUDES: ALLEGAN COUNTY (Townships of Dorr, Fillmore, Heath,
Hopkins, Laketown, Leighton, Manlius, Monterey, Overisel,
Salem, Saugatuck and Wayland); INCLUDES: Barry, Berrien,
Branch, Calhoun, Cass, Hillsdale, Kalamazoo, St. Joseph, Van
Buren

	Rates	Fringes
PAINTER		
Brush and roller.....	\$ 21.75	11.94
Spray, Sandblast, Sign		
Painting.....	\$ 22.75	11.94

PAIN0845-003 05/21/2014

CLINTON COUNTY; EATON COUNTY (does not include the townships of
Bellevue and Olivet); INGHAM COUNTY; IONIA COUNTY (east of Hwy.
M 66); LIVINGSTON COUNTY (west of the eastern city limits of
Howell, including the city of Howell, north to the Genesee
County line and south to the Washtenaw County line); AND

SHIAWASSEE COUNTY (Townships of Bennington, Laingsbury and Perry):

	Rates	Fringes
PAINTER.....	\$ 21.89	11.85

PAIN0845-015 05/21/2014		

MUSKEGON COUNTY; NEWAYGO COUNTY (except the Townships of Barton, Big Prairie, Brooks, Croton, Ensley, Everett, Goodwell, Grant, Home, Monroe, Norwich and Wilcox); OCEANA COUNTY; OTTAWA COUNTY (except the townships of Allendale, Blendone, Chester, Georgetown, Holland, Jamestown, Olive, Park, Polkton, Port Sheldon, Tallmadge, Wright and Zeeland):

	Rates	Fringes
PAINTER.....	\$ 21.89	11.85

PAIN0845-018 05/21/2014		

ALLEGAN COUNTY (Townships of Dorr, Fillmore, Heath, Hopkins, Laketown, Leighton, Manlius, Monterey, Overisel, Salem, Saugatuck and Wayland); IONIA COUNTY (west of Hwy. M-66); KENT, MECOSTA AND MONTCALM COUNTIES; NEWAYGO COUNTY (Townships of Barton, Big Prairie, Brooks, Croton, Ensley, Everett, Goodwell, Grant, Home, Monroe, Norwich and Wilcox); OSCEOLA COUNTY (south of Hwy. #10); OTTAWA COUNTY (Townships of Allendale, Blendone, Chester, Georgetown, Holland, Jamestown, Olive, Park, Polkton, Port Sheldon, Tallmadge, Wright and Zeeland):

	Rates	Fringes
PAINTER.....	\$ 21.89	11.85

FOOTNOTES: Lead abatement work: \$1.00 per hour additional.		

PAIN1011-003 06/05/2014

ALGER, BARAGA, CHIPPEWA, DELTA, DICKINSON, GOGEBIC, HOUGHTON, IRON, KEWEENAW, LUCE, MACKINAC, MARQUETTE, MENOMINEE, ONTONAGON AND SCHOOLCRAFT COUNTIES:

	Rates	Fringes
PAINTER.....	\$ 24.15	10.52

FOOTNOTES: High pay (bridges, overpasses, watertower): 30 to 80 ft.: \$.65 per hour additional. 80 ft. and over: \$1.30 per hour additional.		

PAIN1474-002 06/01/2010

HURON COUNTY; LAPEER COUNTY (east of Hwy. M-53); ST. CLAIR, SANILAC AND TUSCOLA COUNTIES:

	Rates	Fringes
PAINTER.....	\$ 23.79	12.02

FOOTNOTES: Lead abatement work: \$1.00 per hour additional.
 Work with any hazardous material: \$1.00 per hour
 additional. Sandblasting, steam cleaning and acid cleaning:
 \$1.00 per hour additional. Ladder work at or above 40 ft.,
 scaffold work at or above 40 ft., swing stage, boatswain
 chair, window jacks and all work performed over a falling
 height of 40 ft.: \$1.00 per hour additional. Spray gun
 work, pick pullers and those handling needles, blowing off
 by air pressure, and any person rigging (setting up and
 moving off the ground): \$1.00 per hour additional.
 Steeplejack, tanks, gas holders, stacks, flag poles, radio
 towers and beacons, power line towers, bridges, etc.: \$1.00
 per hour additional, paid from the ground up.

 PAIN1803-003 06/01/2017

ALCONA, ALPENA, ANTRIM, ARENAC, BAY, BENZIE, CHARLEVOIX,
 CHEBOYGAN, CLARE, CRAWFORD, EMMET, GLADWIN, GRAND TRAVERSE,
 GRATIOT, IOSCO, ISABELLA, KALKASKA, LAKE, LEELANAU, MANISTEE,
 MASON, MIDLAND, MISSAUKEE, MONTMORENCY AND OGEMAW COUNTIES;
 OSCEOLA COUNTY (north of Hwy. #10); OSCODA, OTSEGO, PRESQUE
 ISLE, ROSCOMMON, SAGINAW AND WEXFORD COUNTIES:

	Rates	Fringes
PAINTER		
Work performed on water, bridges over water or moving traffic, radio and powerline towers, elevated tanks, steeples, smoke stacks over 40 ft. of falling heights, recovery of lead-based paints and any work associated with industrial plants, except maintenance of industrial		
plants.....	\$ 25.10	13.85
All other work, including maintenance of industrial		
plant.....	\$ 23.68	13.85

FOOTNOTES: Spray painting, sandblasting, blowdown associated
 with spraying and blasting, water blasting and work
 involving a swing stage, boatswain chair or spider: \$1.00
 per hour additional. All work performed inside tanks,
 vessels, tank trailers, railroad cars, sewers, smoke
 stacks, boilers or other spaces having limited egress not
 including buildings, opentop tanks, pits, etc.: \$1.25 per
 hour additional.

 PLAS0514-001 06/01/2017

ZONE 1: GENESEE, LIVINGSTON, MACOMB, MONROE, OAKLAND, SAGINAW,
WASHTENAW AND WAYNE COUNTIES

ZONE 2: ALCONA, ALGER, ALLEGAN, ALPENA, ANTRIM, ARENAC, BARAGA,
BARRY, BAY, BENZIE, BERRIEN, BRANCH, CALHOUN, CASS, CHARLEVOIX,
CHEBOYGAN, CHIPPEWA, CLARE, CLINTON, CRAWFORD, DELTA,
DICKINSON, EATON, EMMET, GLADWIN, GOGEBIC, GRAND TRAVERSE,
GRATIOT, HILLSDALE, HOUGHTON, HURON, INGHAM, IONIA, IOSCO,
IRON, ISABELLA, JACKSON, KALAMAZOO, KALKASKA, KENT, KEWEENAW,
LAKE, LAPEER, LEELANAU, LENAWEE, LUCE, MACKINAC, MANISTEE,
MARQUETTE, MASON, MECOSTA, MENOMINEE, MIDLAND, MISSAUKEE,
MONTCALM, MONTMORENCY, MUSKEGON, NEWAYGO, OCEANA, OGEMAW,
ONTONAGON, OSCEOLA, OSCODA, OTSEGO, OTTAWA, PRESQUE ISLE,
ROSCOMMON, SANILAC, SCHOOLCRAFT, SHIAWASSEE, ST. CLAIR, ST.
JOSEPH, TUSCOLA, VAN BUREN AND WEXFORD COUNTIES

	Rates	Fringes
CEMENT MASON/CONCRETE FINISHER		
ZONE 1.....	\$ 30.94	13.59
ZONE 2.....	\$ 29.44	13.59

PLUM0190-003 05/01/2015

ALCONA, ALGER, ALLEGAN, ALPENA, ANTRIM, ARENAC, BARAGA, BARRY,
BAY, BENZIE, BERRIEN, BRANCH, CALHOUN, CASS, CHARLEVOIX,
CHEBOYGAN, CHIPPEWA, CLARE, CLINTON, CRAWFORD, DELTA,
DICKINSON, EATON, EMMET, GENESEE, GLADWIN, GOGEBIC, GRAND
TRAVERSE, GRATIOT, HILLSDALE, HOUGHTON, HURON, INGHAM, IONIA,
IOSCO, IRON, ISABELLA, JACKSON, KALAMAZOO, KALKASKA, KENT,
KEWEENAW, LAKE, LAPEER, LEELANAU, LENAWEE, LIVINGSTON, LUCE,
MACKINAC, MACOMB, MANISTEE, MARQUETTE, MASON, MECOSTA,
MENOMINEE, MIDLAND, MISSAUKEE, MONTCALM, MONTMORENCY, MONROE,
MUSKEGON, NEWAYGO, OAKLAND, OCEANA, OGEMAW, ONTONAGON, OSCEOLA,
OSCODA, OTSEGO, OTTAWA, PRESQUE ISLE, ROSCOMMON, SAGINAW, ST.
CLARE, ST. JOSEPH, SANILAC, SCHOOLCRAFT, SHIAWASSEE, TUSCOLA,
VAN BUREN, WASHTENAW, WAYNE AND WEXFORD COUNTIES

	Rates	Fringes
Plumber/Pipefitter - gas distribution pipeline:		
Welding in conjunction with gas distribution pipeline work.....	\$ 33.03	20.19
All other work:.....	\$ 24.19	12.28

TEAM0007-004 06/01/2017

AREA 1: ALCONA, ALGER, ALLEGAN, ALPENA, ANTRIM, ARENAC, BARAGA,
BARRY, BAY, BENZIE, BERRIEN, BRANCH, CALHOUN, CASS, CHARLEVOIX,
CHEBOYGAN, CHIPPEWA, CLARE, CLINTON, CRAWFORD, DELTA,
DICKINSON, EATON, EMMET, GLADWIN, GOGEBIC, GRAND TRAVERSE,
GRATIOT, HILLSDALE, HOUGHTON, HURON, INGHAM, IONIA, IOSCO,
IRON, ISABELLA, JACKSON, KALAMAZOO, KALKASKA, KENT, KEWEENAW,
LAKE, LAPEER, LEELANAU, LENAWEE, LUCE, MACKINAC, MANISTEE,
MARQUETTE, MASON, MECOSTA, MENOMINEE, MIDLAND, MISSAUKEE,
MONTCALM, MONTMORENCY, MUSKEGON, NEWAYGO, OCEANA, OGEMAW,
ONTONAGON, OSCEOLA, OSCODA, OTSEGO, OTTAWA, PRESQUE ISLE,
ROSCOMMON, SAGINAW, SANILAC, SCHOOLCRAFT, SHIAWASSEE, ST.

CLAIR, ST. JOSEPH, TUSCOLA, VAN BUREN AND WEXFORD COUNTIES

AREA 2: GENESEE, LIVINGSTON, MACOMB, MONROE, OAKLAND, WASHTENAW AND WAYNE COUNTIES

	Rates	Fringes
TRUCK DRIVER		
AREA 1		
Euclids, double bottoms		
and lowboys.....	\$ 25.05	.50 + a+b
Trucks under 8 cu. yds.....	\$ 24.80	.50 + a+b
Trucks, 8 cu. yds. and		
over.....	\$ 24.90	.50 + a+b
AREA 2		
Euclids, double bottomms		
and lowboys.....	\$ 24.895	.50 + a+b
Euclids, double bottoms		
and lowboys.....	\$ 25.15	.50 + a+b
Trucks under 8 cu. yds.....	\$ 24.90	.50 + a+b
Trucks, 8 cu. yds. and		
over.....	\$ 25.00	.50 + a+b

Footnote:

- a. \$455.00 per week
- b. \$64.40 daily

 TEAM0247-004 04/01/2013

AREA 1: ALCONA, ALGER, ALLEGAN, ALPENA, ANTRIM, ARENAC, BARAGA, BARRY, BAY, BENZIE, BERRIEN, BRANCH, CALHOUN, CASS, CHARLEVOIX, CHEBOYGAN, CHIPPEWA, CLARE, CLINTON, CRAWFORD, DELTA, DICKINSON, EATON, EMMET, GLADWIN, GOGEBIC, GRAND TRAVERSE, GRATIOT, HILLSDALE, HOUGHTON, HURON, INGHAM, IONIA, IOSCO, IRON, ISABELLA, JACKSON, KALAMAZOO, KALKASKA, KENT, KEWEENAW, LAKE, LAPEER, LEELANAU, LENAWEE, LUCE, MACKINAC, MANISTEE, MARQUETTE, MASON, MECOSTA, MENOMINEE, MIDLAND, MISSAUKEE, MONTCALM, MONTMORENCY, MUSKEGON, NEWAYGO, OCEANA, OGEMAW, ONTONAGON, OSCEOLA, OSCODA, OTSEGO, OTTAWA, PRESQUE ISLE, ROSCOMMON, SANILAC, SCHOOLCRAFT, SHIAWASSEE, SAGINAW, ST. CLAIR, ST. JOSEPH, TUSCOLA, VAN BUREN AND WEXFORD COUNTIES

AREA 2: GENESEE, LIVINGSTON, MACOMB, MONROE, OAKLAND, WASHTENAW AND WAYNE COUNTIES

	Rates	Fringes
Sign Installer		
AREA 1		
GROUP 1.....	\$ 21.78	11.83
GROUP 2.....	\$ 25.27	11.8375
AREA 2		
GROUP 1.....	\$ 22.03	11.83
GROUP 2.....	\$ 25.02	11.8375

FOOTNOTE:

- a. \$132.70 per week, plus \$17.80 per day.

SIGN INSTALLER CLASSIFICATIONS:

GROUP 1: performs all necessary labor and uses all tools required to construct and set concrete forms required in the installation of highway and street signs

GROUP 2: performs all miscellaneous labor, uses all hand and power tools, and operates all other equipment, mobile or otherwise, required for the installation of highway and street signs

TEAM0247-010 04/01/2016

AREA 1: LAPEER AND SHIAWASSEE COUNTIES

AREA 2: GENESEE, MACOMB, MONROE, OAKLAND, ST. CLAIR, WASHTENAW AND WAYNE COUNTIES

	Rates	Fringes
TRUCK DRIVER (Underground construction)		
AREA 1		
GROUP 1.....	\$ 22.82	17.885
GROUP 2.....	\$ 22.91	17.885
GROUP 3.....	\$ 23.12	17.885
AREA 2		
GROUP 1.....	\$ 23.12	17.885
GROUP 2.....	\$ 23.26	17.885
GROUP 3.....	\$ 23.00405.90/wk+59.50/day	

PAID HOLIDAYS: New Year's Day, Memorial Day, Fourth of July, Labor Day, Thanksgiving Day and Christmas Day.

SCOPE OF WORK: Excavation, site preparation, land balancing, grading, sewers, utilities and improvements; also including but not limited to, tunnels, underground piping, retention, oxidation, flocculation facilities, conduits, general excavation and steel sheeting for underground construction. Underground construction work shall not include any structural modifications, alterations, additions and repairs to buildings or highway work, including roads, streets, bridge construction and parking lots or steel erection.

TRUCK DRIVER CLASSIFICATIONS

GROUP 1: Truck driver on all trucks (EXCEPT dump trucks of 8 cubic yards capacity or over, pole trailers, semis, low boys, Euclid, double bottom and fuel trucks)

GROUP 2: Truck driver on dump trucks of 8 cubic yards capacity or over, pole trailers, semis and fuel trucks

GROUP 3: Truck driver on low boy, Euclid and double bottom

SUMI2002-001 05/01/2002

Rates	Fringes
-------	---------

Flag Person.....	\$ 10.10	0.00
LINE PROTECTOR (ZONE 1: GENESEEE, MACOMB, MONROE, OAKLAND, WASHTENAW AND WAYNE)....	\$ 18.98	12.17
LINE PROTECTOR (ZONE 2: STATEWIDE (EXCLUDING GENESEEE, MACOMB, MONROE, OAKLAND, WASHTENAW AND WAYNE).....	\$ 17.14	12.17
Pavement Marking Machine (ZONE 1: GENESEEE, MACOMB, MONROE, OAKLAND, WASHTENAW AND WAYNE COUNTIES) Group 1.....	\$ 24.89	12.17
Pavement Marking Machine (ZONE 1: GENESEEE, MACOMB, MONROE, OAKLAND, WASHTENAW AND WAYNE) Group 2.....	\$ 22.40	12.17
Pavement Marking Machine (ZONE 2: STATEWIDE (EXCLUDING GENESEEE, MACOMB, MONROE, OAKLAND, WASHTENAW AND WAYNE COUNTIES) Group 1.....	\$ 22.89	12.17
Pavement Marking Machine (ZONE 2: STATEWIDE (EXCLUDING GENESEEE, MACOMB, MONROE, OAKLAND, WASHTENAW AND WAYNE) Group 2.....	\$ 20.60	12.17

WORK CLASSIFICATIONS:

PAVEMENT MARKER GROUP 1: Drives or operates a truck mounted striper, grinder, blaster, groover, or thermoplastic melter for the placement or removal of temporary or permanent pavement markings or markers.

PAVEMENT MARKER GROUP 2: Performs all functions involved for the placement or removal of temporary or permanent pavement markings or markers not covered by the classification of Pavement Marker Group 1 or Line Protector.

LINE PROTECTOR: Performs all operations for the protection or removal of temporary or permanent pavement markings or markers in a moving convoy operation not performed by the classification of Pavement Marker Group 1. A moving convoy operation is comprised of only Pavement Markers Group 1 and Line Protectors.

WELDERS - Receive rate prescribed for craft performing operation to which welding is incidental.
=====

Note: Executive Order (EO) 13706, Establishing Paid Sick Leave for Federal Contractors applies to all contracts subject to the Davis-Bacon Act for which the contract is awarded (and any solicitation was issued) on or after January 1, 2017. If this contract is covered by the EO, the contractor must provide employees with 1 hour of paid sick leave for every 30 hours they work, up to 56 hours of paid sick leave each year. Employees must be permitted to use paid sick leave for their own illness, injury or other health-related needs, including preventive care; to assist a family member (or person who is like family to the employee) who is ill, injured, or has other health-related needs, including preventive care; or for reasons resulting from, or to assist a family member (or person who is like family to the employee) who is a victim of, domestic violence, sexual assault, or stalking. Additional information on contractor requirements and worker protections under the EO is available at www.dol.gov/whd/govcontracts.

Unlisted classifications needed for work not included within the scope of the classifications listed may be added after award only as provided in the labor standards contract clauses (29CFR 5.5 (a) (1) (ii)).

The body of each wage determination lists the classification and wage rates that have been found to be prevailing for the cited type(s) of construction in the area covered by the wage determination. The classifications are listed in alphabetical order of "identifiers" that indicate whether the particular rate is a union rate (current union negotiated rate for local), a survey rate (weighted average rate) or a union average rate (weighted union average rate).

Union Rate Identifiers

A four letter classification abbreviation identifier enclosed in dotted lines beginning with characters other than "SU" or "UAVG" denotes that the union classification and rate were prevailing for that classification in the survey. Example: PLUM0198-005 07/01/2014. PLUM is an abbreviation identifier of the union which prevailed in the survey for this classification, which in this example would be Plumbers. 0198 indicates the local union number or district council number where applicable, i.e., Plumbers Local 0198. The next number, 005 in the example, is an internal number used in processing the wage determination. 07/01/2014 is the effective date of the most current negotiated rate, which in this example is July 1, 2014.

Union prevailing wage rates are updated to reflect all rate changes in the collective bargaining agreement (CBA) governing this classification and rate.

Survey Rate Identifiers

Classifications listed under the "SU" identifier indicate that no one rate prevailed for this classification in the survey and the published rate is derived by computing a weighted average

rate based on all the rates reported in the survey for that classification. As this weighted average rate includes all rates reported in the survey, it may include both union and non-union rates. Example: SULA2012-007 5/13/2014. SU indicates the rates are survey rates based on a weighted average calculation of rates and are not majority rates. LA indicates the State of Louisiana. 2012 is the year of survey on which these classifications and rates are based. The next number, 007 in the example, is an internal number used in producing the wage determination. 5/13/2014 indicates the survey completion date for the classifications and rates under that identifier.

Survey wage rates are not updated and remain in effect until a new survey is conducted.

Union Average Rate Identifiers

Classification(s) listed under the UAVG identifier indicate that no single majority rate prevailed for those classifications; however, 100% of the data reported for the classifications was union data. EXAMPLE: UAVG-OH-0010 08/29/2014. UAVG indicates that the rate is a weighted union average rate. OH indicates the state. The next number, 0010 in the example, is an internal number used in producing the wage determination. 08/29/2014 indicates the survey completion date for the classifications and rates under that identifier.

A UAVG rate will be updated once a year, usually in January of each year, to reflect a weighted average of the current negotiated/CBA rate of the union locals from which the rate is based.

WAGE DETERMINATION APPEALS PROCESS

1.) Has there been an initial decision in the matter? This can be:

- * an existing published wage determination
- * a survey underlying a wage determination
- * a Wage and Hour Division letter setting forth a position on a wage determination matter
- * a conformance (additional classification and rate) ruling

On survey related matters, initial contact, including requests for summaries of surveys, should be with the Wage and Hour Regional Office for the area in which the survey was conducted because those Regional Offices have responsibility for the Davis-Bacon survey program. If the response from this initial contact is not satisfactory, then the process described in 2.) and 3.) should be followed.

With regard to any other matter not yet ripe for the formal process described here, initial contact should be with the Branch of Construction Wage Determinations. Write to:

Branch of Construction Wage Determinations
Wage and Hour Division
U.S. Department of Labor

200 Constitution Avenue, N.W.
Washington, DC 20210

2.) If the answer to the question in 1.) is yes, then an interested party (those affected by the action) can request review and reconsideration from the Wage and Hour Administrator (See 29 CFR Part 1.8 and 29 CFR Part 7). Write to:

Wage and Hour Administrator
U.S. Department of Labor
200 Constitution Avenue, N.W.
Washington, DC 20210

The request should be accompanied by a full statement of the interested party's position and by any information (wage payment data, project description, area practice material, etc.) that the requestor considers relevant to the issue.

3.) If the decision of the Administrator is not favorable, an interested party may appeal directly to the Administrative Review Board (formerly the Wage Appeals Board). Write to:

Administrative Review Board
U.S. Department of Labor
200 Constitution Avenue, N.W.
Washington, DC 20210

4.) All decisions by the Administrative Review Board are final.

=====

END OF GENERAL DECISION